

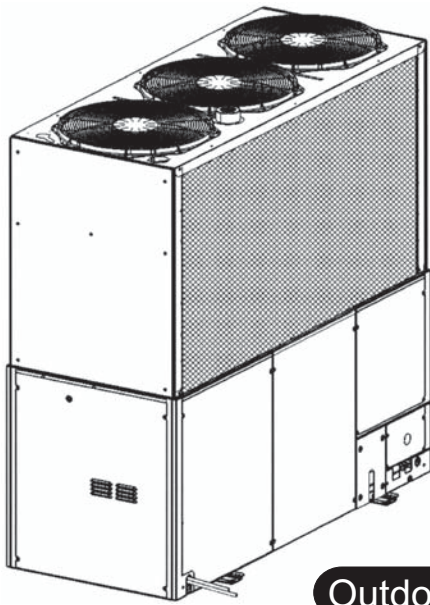

OPERATION MANUAL

Aisin Gas Heat Pump Air Conditioner



Outdoor Unit

■ Applicable models

AXGP096D1NHS

AXGP180D1NHS

-
- **READ THESE OPERATING INSTRUCTIONS CAREFULLY BEFORE USING THE UNIT.**
Follow the safety considerations listed in this manual.
 - **Keep this Operation Manual in a handy place for future reference.**
Upon change of ownership, transfer this manual to the equipment owner.
 - **Read this manual along with the Maintenance Instruction of the indoor unit.**
This manual should be stored along with the Maintenance Instruction.



CONTENTS



1. SAFETY CONSIDERATIONS2
 2. WHAT TO DO BEFORE OPERATION8
 3. OPERATION RANGE10
 4. OPERATION PROCEDURE10
 5. OPTIMUM OPERATION14
 6. SEASONAL MAINTENANCE14
 7. FOLLOWING CONDITIONS ARE NOT TO BE CONCERNED15
 8. TROUBLE SHOOTING17
 9. ERROR CODE LIST18
 10. WARRANTIES AND LIABILITIES19
 11. AFTER SALE SERVICE19

1. SAFETY CONSIDERATIONS







Read these **SAFETY CONSIDERATIONS for Operations** carefully before installing the unit and be sure to install it correctly. After completing the installation, make sure that the system operates properly during commissioning.

Meaning of **DANGER, WARNING, CAUTION** and **NOTE** Symbols.

 DANGER	Indicates an imminently hazardous situation which, if not avoided, may result in death or serious injury.
 WARNING	Indicates a potentially hazardous situation which, if not avoided, may result in death or serious injury.
 CAUTION	Indicates a potentially hazardous situation which, if not avoided, may result in minor or moderate injury. It may also be used to alert against unsafe practices.
NOTE	Indicates situations that may result in equipment or property-damage accidents only.

	Indicates a prohibited action.
	Indicates an action or requirement that must be observed.

⚠ DANGER

Do not install the unit yourself. Improper installation may result in water leakage, electric shock, a fire or other hazards. Ask your dealer to carry out the installation work.	
Do not install any additional options yourself. Improper installation may result in water leakage, electric shock, a fire or other hazards. Be sure to use only the specified options and have them installed by your dealer.	
Do not install the unit in the area where flammable materials are present. Installing a unit in such location could cause a fire, an explosion or other hazards.	
Stop operation, turn off the power and contact your dealer immediately when any abnormalities are noticed during operation. (burning smells, smoke, etc.) Leaving the unit running under such circumstances may damage the unit, or result in electrical shock, a fire or other hazards.	
If any refrigerant vapor leaks, discontinue use of the product, ventilate the area thoroughly and extinguish any open flame near the product right away and contact your dealer. Toxic gas may be produced if the refrigerant vapor comes into contact with other flammable or oxidising materials from devices such as fan, heater, stove, cooking device, etc.	
For refrigerant vapor leakage, consult with your dealer. Refrigerant vapor is heavier than air and replaces oxygen. A massive leak could lead to oxygen deficiency, especially in basements, and a suffocation hazard could occur.	
Safely dispose of all packing materials. Packaging materials, such as nails and other metal or wooden parts may cause cuts, pricks, or other injuries.	

<p>When installing the unit in a small room, take measures to keep refrigerant concentration from exceeding allowable safety limits in case of refrigerant leakage.</p> <p>Refrigerant vapor is heavier than air and replaces oxygen. Excessive refrigerant in a closed space can lead to oxygen deficiency, especially in a small room and a suffocation hazard could occur.</p>	⚠	<p>Do not dismantle, modify or repair the unit by yourself.</p> <p>Improper repair and maintenance may result in water leakage, electrical shock, a fire or other hazards. Contact your dealer to perform this work. Only use included accessories that are specifically designed for use with the equipment and have them installed by qualified technician.</p>	⊘
<p>If equipment utilizing a burner, such as a cooking stove or a room heater, is used in the same room as the indoor unit, be sure to ventilate the room sufficiently to avoid the danger of oxygen deficiency.</p> <p>Failure to do so may cause a suffocation hazard.</p>	⚠	<p>Do not install the unit where the smoke from oil fill, for example, in a kitchen or where volatile gas, corrosive gas or metallic dust may be produced.</p> <p>Doing so may cause a fire, malfunction or other hazards.</p>	⊘
<p>Tear apart and throw away plastic packing bags so that children will not play with them.</p> <p>Children playing with plastic bags face the danger by suffocation.</p>	⚠	<p>When any fuel gas leaks from the outdoor unit, shut off the fuel supply at the main valve and contact your dealer immediately.</p> <p>May cause a fire or an explosion by the ignition sparks or open flame near by.</p>	⚠
<p>Do not install the outdoor unit indoor or in a location into which exhaust gas could flow.</p> <p>Make sure that exhaust gas is not being discharged near an air intake port or windows where it could be drawn into the room and cause gas poisoning or suffocation.</p>	⊘	<p>When the unit is submerged in water affected by acts of nature such as floods or hurricanes, turn off the main power circuit breaker and contact your dealer.</p> <p>Operating the unit continuously may cause malfunction, electrical shock or a fire.</p>	⚠
<p>Be sure to ground the unit.</p> <p>Inproper grounding may cause electrical shock or a fire.</p>	⚠	<p>Never use the same pipe for condensation of water vapor in the exhaust gas from the outdoor unit and drain water condensed from the indoor unit.</p> <p>If exhaust gas enters the building, it could cause gas poisoning or suffocation.</p>	⊘
<p>Do not connect the ground wire to utility pipes, arrester, or ground wires for electric devices.</p> <p>A high surge current from lighting or other sources may cause damage to the air conditioner.</p>	⊘	<p>Always discharge exhaust gas to the outside of building, so it will not cause adverse affects in the surrounding area.</p> <p>If the air intake draws exhaust gas from a vent or a drainage, it may cause lack of oxygen and/or carbon poisoning.</p>	⚠
<p>Do not block the air intake or exhaust vents of the outdoor unit.</p> <p>Carbon monoxide produced by the incomplete combustion may cause gas poisoning.</p>	⊘	<p>Be sure to install the exhaust pipe to lead exhaust gas to the open air.</p> <p>In the situation where the exhaust pipe needs to run through closed drainage/gutter or into the same location as indoor unit condensation drainage goes, make sure that exhaust gas disperses in to the open air. Failure to do so may lead exhaust gas into the room, cause lack of oxygen and/or carbon poisoning.</p>	⚠
<p>Do not install the unit where volatile oil constituent such as cooking oil or machine oil suspends in the air.</p> <p>Doing so may cause the unit to crack, or may be a cause of electrical shock, a fire or other hazards.</p>	⊘		

—  **WARNING** —

<p>Do not expose your body directly to the cold or warm air flow for a long time. Do not cool or heat the room too much.</p> <p>Prolonged exposure may cause health problems or illness.</p>	⊘
<p>Make sure that all electrical work is carried out by qualified technician according to local, state, and national regulations.</p> <p>Improper electrical construction may lead to electrical shock or a fire.</p>	⚠
<p>Install the unit on a foundation strong enough to withstand its weight.</p> <p>Insufficient strength of foundation may cause the unit to tip over, resulting in injuries or other accidents.</p>	⚠
<p>Do not put fingers, sticks, or any foreign object into the air inlet, air outlet or horizontal flap of the unit.</p> <p>Since the fan rotates at high speed during operation, it may cause injury.</p>	⊘
<p>Do not put fingers, sticks, or any foreign object into the fan since it may start to work suddenly even though it has stopped.</p> <p>Doing so may cause injury.</p>	⊘
<p>When a fuse blows out, never replace it with one of incorrect ampere ratings or different wires.</p> <p>Using incorrect fuses or wires as a replacement may cause a fire or malfunction. Always replace any blown fuse with a fuse of the same specification.</p>	⊘
<p>Contact your dealer to move and reinstall the air conditioner.</p> <p>Incomplete installation may result in water leakage, electric shock, a fire or other hazards.</p>	⚠
<p>Never let the indoor unit or the remote controller get wet.</p> <p>Water can cause electric shock, a fire or other hazards.</p>	⊘
<p>Never use flammable spray such as hair spray, insecticide, lacquer, or paint near the unit.</p> <p>Doing so may cause the unit to crack, or may be a cause of electrical shock, a fire or other hazards.</p>	⊘

<p>Never remove the fan guard of the unit.</p> <p>Since the fan rotates at high speed during operation, it may cause injury.</p>	⊘
<p>Turn off all electrical power before doing any maintenance.</p> <p>Failure to do so could result in electrical shock or injury. Make sure that the fan has stopped before working on the unit.</p>	⚠
<p>Never spray or flush, with water or any other fluids on to the unit.</p> <p>May cause electrical shock including death.</p>	⊘
<p>Do not touch the switch with wet hands.</p> <p>Touching a switch with wet hands can cause electric shock.</p>	⊘
<p>Do not allow children to play on or around the unit.</p> <p>Playing on or around the unit could cause injury.</p>	⊘
<p>Heat exchanger fins are sharp enough to cut. Wear gloves or cover the fins while working around them.</p> <p>Failure to do so could result in injury.</p>	⚠
<p>Check the unit foundation for damage on a continuous basis, especially if it has been in use for a long time.</p> <p>If left in a damaged condition, the unit may fall and cause injury.</p>	⚠
<p>Do not place anything containing water or other fluids on top of the unit.</p> <p>If spilled, may cause a fire or electrical shock including death.</p>	⊘
<p>Do not touch the air outlet or horizontal blades while the swing flap is in operation.</p> <p>Fingers may get caught and injured.</p>	⊘
<p>Do not open the controller cover or touch the internal parts.</p> <p>May cause electrical shock including death or system malfunction. When internal part adjustment or check out is required, please contact your dealer.</p>	⊘
<p>Be sure to install a ground fault circuit breaker.</p> <p>Failure to do so may result in electric shock or a fire.</p>	⚠
<p>Do not stand on, or place any object on the outdoor unit.</p> <p>It may be a cause of injury due to falling or over-turning.</p>	⊘

Do not touch the outdoor unit exhaust pipe. May cause severe burns.	⊘
Do not leave animals and plants in places where wind from the air conditioner flows directly. This may cause adverse effects on the animals or the plants.	⊘
Do not install the outdoor unit in a location where exhaust gas or air from its blower fan comes in contact with plants or animals. The exhaust gas or air from the blower fan could cause harm to the animals or the plants.	⊘
Keep spray canisters away at least 4 feet from the air outlet. Heat from indoor/outdoor unit air outlet may cause the canisters to explode.	⚠
Do not use steam generating equipment such as the water heater near the remote controller or indoor unit. Water droplets might fall during cooling operation and cause short circuit.	⊘
When you need to work on the unit at a high place, make sure to secure the footing. May cause injuries due to falling or over-turning.	⚠
Never install the unit in the area where flammable gas is generated, flows into, accumulates or leaks. If the gas leaks and builds up around the unit, it may catch fire.	⊘
Do not assign the unit to the location where installer or service technician can not secure his/her footing. May cause injuries due to falling or over-turning.	⊘
Never use the same pipe for the outdoor unit to drain both of exhaust gas condensate and condensed water. Exhaust gas may backflow into the outdoor unit and cause malfunction.	⊘
Be sure to use a designated power circuit. Sharing the power supply with other appliances may cause overheat, a fire or malfunction.	⚠

Never pull or twist the electric wire of the remote controller. The wiring may be disconnected and cause electric leakage, or cause the unit to malfunction.	⊘
When installing the outdoor unit on the rooftop, route the exhaust drain piping so that exhaust gas condensate can be discharged into the rainwater drainage (roof drainage). Routing the exhaust piping directly onto the rooftop may damage the concrete structure or waterproof sheet.	⚠
Do not place appliances that produce open flames in places that are exposed to the air flow of the unit or under the indoor unit. It may cause oxygen deficiency due to incomplete combustion or deformation of the unit due to the heat.	⊘

—  **CAUTION** —

Do not use the system for any purpose other than comfort cooling or heating. Do not use the unit for cooling precision instruments, food, plants, animals or works of art. This may cause adverse effects on the object's performance, quality and longevity.	⊘
Do not place any items you do not wish to get wet below the indoor unit. When the humidity level exceeds 80% or due to a clogged condensation drain pipe, water may drip from the indoor unit.	⊘
Before cleaning exterior, stop the system operation by turning the designated breaker switch off and by shutting off the outdoor unit by disconnecting the power cord from the socket. Failure to do so may cause electrical shock including death.	⚠
Do not wash the unit with excessive water. Doing so may result in electric shock or a fire.	⊘

<p>Do not place the controller near water splashes. Water entering the controller may cause electric shock or damage the internal electronic parts.</p>	⊘
<p>Do not shut off the power immediately after turning the switch off. The system requires at least 5 minutes to complete the draining process after being turned off.</p>	⊘
<p>Do not operate the system when using a room-fumigation type of insecticide. Failure to observe this could cause the chemicals to be deposited in the unit and can endanger health or create additional hazards.</p>	⊘
<p>Never let children or anyone who requires supervision operate the system on their own. Improper operation may cause health problems or other hazards.</p>	⊘
<p>Do not let children play with the controller. Improper operation may cause health problems or other hazards. Keep the controller out of their reach.</p>	⊘
<p>Always consult with your dealer to clean inside of unit. Improper cleaning or use of incorrect detergent may not only harm the unit, but also could cause injuries, electrical shock, water leakage, a fire, malfunction, or other hazardous situation.</p>	⚠
<p>Do not touch the air intake or aluminum fins. Doing so may cause cuts or other injuries.</p>	⊘
<p>Do not place objects or let dead leaves pile up around the unit. Dead leave piles may attract small animals as their nesting site. If those animals get inside of outdoor unit, it may cause not only system malfunction but also a fire or other hazardous situation.</p>	⊘
<p>Be sure to arrange the drain piping to ensure smooth drainage. Improper drain piping may cause water leakage and malfunction.</p>	⚠

Location for installation

Make sure that the unit is installed in a sufficiently ventilated area and not surrounded by obstacles.

Especially using the unit in the following places may create a risk of human injury or damage to property. Do not install the unit in such locations including without limitation the following:

- a. Places with a mist of mineral oil, such as cutting oil.
- b. Locations such as coastal areas where there is a lot of salt in the air.
- c. Locations such as hot springs where there is a lot of sulfur in the air.
- d. Locations such as factories where their power voltage requirement varies
- e. In cars, boats, and other vehicles.
- f. Locations such as kitchens where oil may splatter or where there is steam in the air.
- g. Locations where equipment produces electromagnetic waves.
- h. Places with an acid or an alkaline mist.
- i. Places where fallen leaves can accumulate or where weeds can grow.

Do not expose the controller to direct sunlight.

The LCD display can become discolored and may fail to display the data.

If there is any possibility of the exhaust gas flowing into the room or causing adverse effects on the surrounding area, consider the use of an exhaust vent extension kit (additional option).

Contact your dealer for more details.

If the unit is installed in a region with heavy snowfall, take snow protection measures.

Contact your dealer for the details of snow protection measures, such as the use of a snow protection hood (additional option).

During the unit operation

Do not block the air inlet, exhaust vent or exhaust drain outlet of the outdoor unit.

Doing so may cause malfunction.

Do not use any other room heater near the indoor unit.

Heat may deform the suction grille of the indoor unit.

Do not block the air inlet or air outlet of the unit.

Doing so may lower the performance of the air conditioner or cause malfunction.

If any oil or coolant leaks from the outdoor unit, it may cause malfunction or secondary damage to household property. In such cases, contact your dealer.

Do not repeat turning ON and OFF the system within a short period of time.

If the unit is turned off and turned back on in a few minutes, 4 or 5 times or more per hour, it may cause compressor malfunction, or otherwise damage the unit.

Never press the button of the remote controller with a hard, pointed object.

The remote controller may be damaged.

Do not wipe the controller operation panel with benzene, thinner, chemical dust cloth, etc.

The panel may get discolored or the coating can peel off. If it is dirty, soak a cloth in water-diluted neutral detergent, squeeze it well and wipe the panel clean. Then wipe it with another dry cloth.

Electric wiring work

Do not attempt to do electrical work or grounding work unless you are licensed to do so.

Consult with your dealer for electrical work and grounding work.

Make sure that a designated power circuit is used.

Operation sound

Pay attention to operation sound. Be sure to operate the system in the following places;

- a. Places that can sufficiently withstand the weight of the unit yet can suppress the operating sound and vibration of the unit.
- b. Places where warm air from the air outlet of the outdoor unit or the operating sound of the outdoor unit does not annoy neighbors.

Make sure that there are no obstacles close to the outdoor unit.

Obstacles close to the outdoor unit may drop the performance of the outdoor unit or increase the operation sound of the outdoor unit.

Consult your dealer if the system in operation generates unusual noise.

Drain piping work

Make sure that the drainpipe is installed properly to drain water.

If no water is discharged from the drainpipe while the system is in the cooling mode, the drainpipe may be clogged with dust or dirt and water leakage from the indoor unit may occur. Stop operating the system and contact your dealer.

Important reminder

If the system is operated exceeding the specified allowable temperature range, especially when the ambient temperature is high, the unit may be damaged or the protection circuit may be activated to stop operation.

To ensure the longevity of the unit performance, or to protect the unit, the operation of indoor and outdoor units may be suspended, or the heating or cooling capacity may drop temporarily. However, it automatically returns to the original condition (defrost operation). In such condition, gas and electricity consumption may be increased.

Dismantling of the unit, disposal of the refrigerant, oil, and additional parts, should be done by the qualified technician in accordance with the relevant local, state, and national regulations.



2. WHAT TO DO BEFORE OPERATION

Installation site

This operation manual is for the following systems with standard control. Before initiating operation, contact your dealer for the operation that corresponds to your system type and mark.

If your installation has a customized control system, ask your dealer for the operation that corresponds to your system.

The system provides 3 operation modes;

	COOL/HEAT selector	Operation modes
Gas heat pump air conditioner	o yes o no	  

Names and functions of parts

System

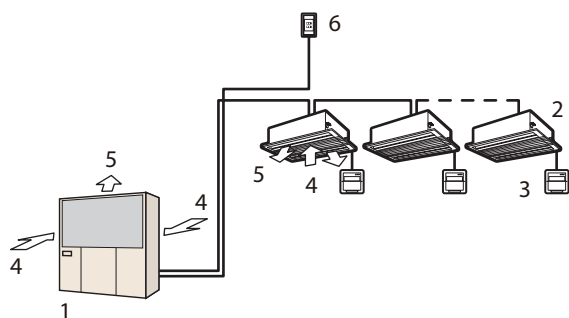

1. Outdoor unit
2. Indoor unit
3. Remote controller
4. Inlet air
5. Outlet air
6. COOL/HEAT selector

(Above figure shows systems with changeover remote control switches)

Outdoor unit

AXGP096D1NHS

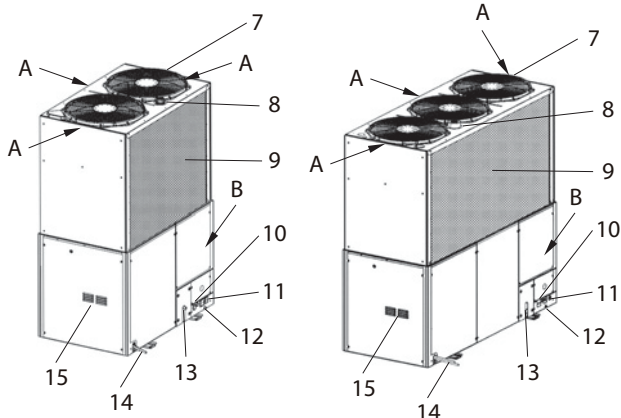

AXGP180D1NHS



7. Air outlet (Fan)
8. Engine exhaust vent

9. Air inlet (Heat exchanger)
10. Power supply, transmission wiring port
11. Refrigerant pipe connecting port
12. Condensed water drain
13. Fuel pipe connecting port
14. Exhaust water drain
15. Engine intake vent

CAUTION/WARNING label A

 WARNING	Fan in movement Do not insert fingers, sticks, or etc.
 CAUTION	Hot surface may result in burn injury. Do not touch the exhaust gas outlet.

CAUTION/WARNING label B

Recovery and destructive law of Freon First class specialized specific products

This product uses HFC as a refrigerant.

- 1) Indiscriminate hydrofluorocarbon (HFC) emission into the atmosphere is prohibited.
- 2) HFC recovery is required before disposing this product (comply with current norm)
- 3) The type and quantity of the HFC are indicated on the "Precautions for installation and inspection" label inside the control box panel.

 **WARNING**

- 1) Risk of exhaust gas pollution accumulated indoors.
-Drain hose of indoor and outdoor units should not be connected to the same drainage pipe.
-Discharge the exhaust drain in the open space outdoors.
- 2) Possibility of gas poisoning due to engine's exhaust gas.
-Convey the engine's exhaust gas directly to open outdoor spaces.
- 3) Danger of gas leakage
-Use only specific and qualified pipes and flexible hoses for fuel gas.
- 4) Danger of oxygen deficiency indoors or unit malfunction due to possible refrigerant leakage.
-After installation, perform pressure test to the piping network, to detect for any refrigerant gas leakage.
- 5) If you smell gas: Do the following precautions.
-Like shut off gas valve, Remove power, Call appropriate service personnel.

 **WARNING**

Risk of electric shock, can cause injury or death.
Disconnect all remote electric power supplies before servicing.

 **CAUTION**

Drainage could possibly taint the concrete surface or damage the water proof sheet of the roof or floor
-Extend the drainage to the gutter or drain of the roof

 **CAUTION**

Use copper supply conductors only.

Remote Controller

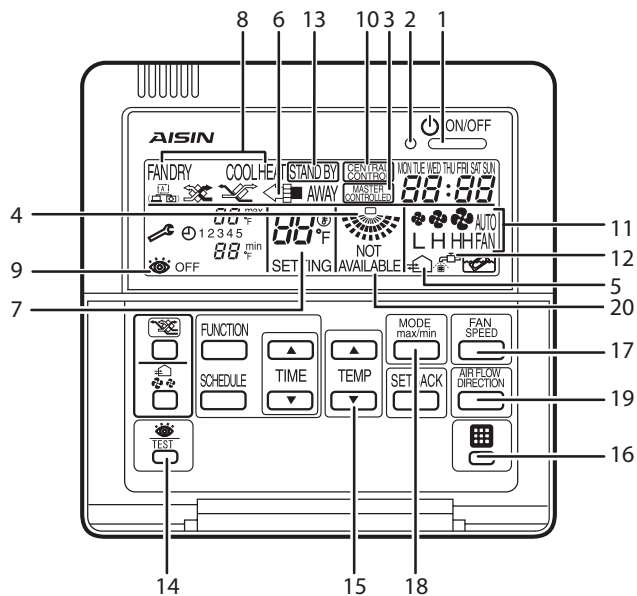
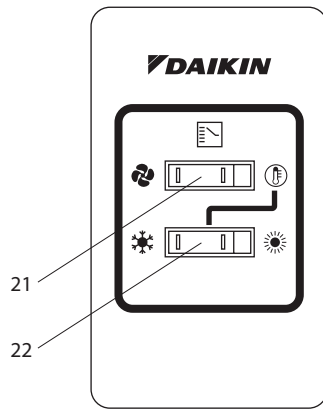











Fig. 1





ABRC1D71

■ Cool/heat selector



1	ON/OFF button
	Press the button and the system will start. Press the button again and the system will stop.
2	OPERATION LAMP (RED)
	The operation lamp lights up during operation or blinks if a malfunction occurs.
3	DISPLAY “” (CHANGEVER UNDER CENTRALIZED CONTROL)
	This icon indicates that the change-over of the installation is under centralized control assigned to another indoor unit or optional cool/heat selector connected to the outdoor unit (main remote controller). It is impossible to changeover heat/cool with the remote controller when this icon is displayed.
4	DISPLAY “” (AIR FLOW DIRECTION)
	This icon indicates the air flow direction (only for installations with motorized horizontal flaps). For more details, refer to the chapter "4-3 ADJUSTING THE AIR FLOW DIRECTION" on page 12.
5	DISPLAY “” (VENTILATION)
	This icon appears when the ventilation is adjusted with the ventilation amount button (HRV only).
6	DISPLAY “” (AIR CLEANING)
	This icon indicates that the air cleaning unit (optional accessory) is in operation.
7	DISPLAY “” (SET TEMPERATURE)
	This display shows the set temperature.
8	DISPLAY “FAN DRY COOL HEAT” (OPERATION MODE)
	This display shows the current OPERATION MODE.
9	DISPLAY “” (INSPECTION/TEST OPERATION)
	When the INSPECTION/TEST OPERATION BUTTON is pressed, the display shows the system mode is on.

10	DISPLAY “” (UNDER CENTRALIZED CONTROL)
	When this display shows, another controller with higher priority is controlling or disabling your installation, and the system is UNDER CENTRALIZED CONTROL. (This is not a standard specification.)
11	DISPLAY “” (FAN SPEED)
	This display shows the set fan speed, L: LOW, H: HIGH or HH: very HIGH. Only two fan speed adjustment levels, low and high may be available depending on the type of indoor unit.
12	DISPLAY “” (TIME TO CLEAN AIR FILTER)
	This icon indicates that the air filter must be cleaned. For more details, refer to the maintenance instruction attached to the indoor unit.
13	DISPLAY “” (DEFROST/HOT START)
	This icon indicates that the defrost/hotstart mode is active. Refer to the chapter "EXPLANATION OF HEATING OPERATION" on page 11.
14	INSPECTION/TEST OPERATION button
	This button is used only by qualified service persons for maintenance purposes. Do not use it in normal operation
15	TEMPERATURE SETTING button
	Use this button for SETTING TEMPERATURE of the thermostat.
16	FILTER SIGN RESET button
	This button is used to reset the air filter cleaning time icon. If the filter sign lamp lights up, clean the air filter as explained in the maintenance instruction attached to the indoor unit. After cleaning and reinstalling the air filter, press the filter sign reset button on the remote controller. The filter sign lamp on the display will go out. For more details, refer to the maintenance instruction attached to the indoor unit.
17	FAN SPEED CONTROL button
	Press this button to select the fan speed, LOW, HIGH or very HIGH of your choice. Only two fan speed adjustment levels, low and high may be available depending on the type of indoor unit.
18	OPERATION MODE SELECTOR button
	Press this button to select OPERATION MODE.
19	AIR FLOW DIRECTION ADJUST button
	This button enables to adjust the air flow direction. Refer to the chapter "4-3 ADJUSTING THE AIR FLOW DIRECTION" on page 12.

20	NON-FUNCTIONING DISPLAY
	If that particular function is not available, pressing the button may display the words "NOT AVAILABLE" for a few seconds. When running multiple units at the same time, the "NOT AVAILABLE" message will appear only if none of the indoor units is equipped with the function. If one of the indoor units is equipped with the function, the display will not appear.
21	FAN ONLY/AIR CONDITIONING SELECTOR SWITCH
	Set the switch to "  " for fan only operation or to "  " for heating or cooling operation.
22	COOL/HEAT CHANGEOVER SWITCH
	Set the switch to "  " for cooling or to "  " for heating operation.

NOTE

- For the sake of explanation, all indications are shown on the display in Fig. 1 contrary to actual operating situations.
- To use some functions, the installation of optional accessories, or the HRV unit sold separately are required. Contact your dealer for details.
- HRV is short for Heat Reclaim Ventilation, which is the system recovering heat energy lost through ventilation and holding down room temperature changes caused by ventilation.
- See the operation manual attached to the remote controller for details on the schedule timer, each buttons and functions.

3. OPERATION RANGE

Use the system in the following temperature and humidity ranges for safe and effective operation.



	COOLING	HEATING
outdoor temperature	23°~130°FDB	14°~77°FWB
indoor temperature	57°~75°FWB	50°~82°FDB
indoor humidity	≤ 80%*	

*To avoid condensation and water dripping out the unit.
If the temperature or the humidity is beyond these conditions, safety devices will work and the system will not operate.

4. OPERATION PROCEDURE

- Operation procedure varies according to the combination of outdoor unit and remote controller. Read the chapter "2. WHAT TO DO BEFORE OPERATION" on page 8.
- To protect the unit, turn on the main power switch 6 hours before operation.
For smooth start of the operation, do not turn off the main power switch during the air conditioning season.
- If the main power supply is turned off during operation, operation will restart automatically after the power turns back on again.

4-1 COOLING, HEATING AND FAN ONLY OPERATION

- The operation mode cannot be changed with the remote controller whose display shows "  " (CHANGE OVER UNDER CONTROL).
- When the display "  " (CHANGE OVER UNDER CONTROL) flashes, refer to the chapter "4-4 SETTING THE MAIN REMOTE CONTROLLER" on page 13.
- The fan may keep on running for over 1 minute after the heating operation stops to remove the heat in the indoor units.
- The air flow rate may adjust automatically depending on the room temperature or the fan may stop immediately. This is not a malfunction.
- To protect the unit, the system may control the air flow rate automatically.
- It may take some time to change the air flow rate. This is not a malfunction.

FOR SYSTEMS WITHOUT COOL/HEAT SELECTOR

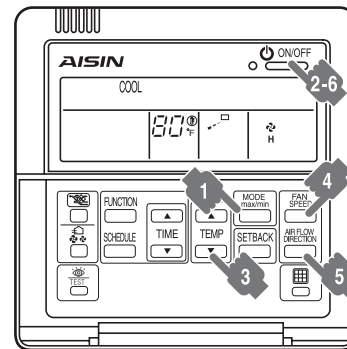

- 1 Press the operation mode selector button several times and select the operation mode of your choice;
 - "COOL" Cooling operation
 - "HEAT" Heating operation
 - "FAN" Fan only operation
- 2 Press the on/off button.
The operation lamp lights up and the system starts operation.

FOR SYSTEMS WITH COOL/HEAT SELECTOR

- 1 Select operation mode with the COOL/HEAT selector as follows:

"  " "  " Cooling operation

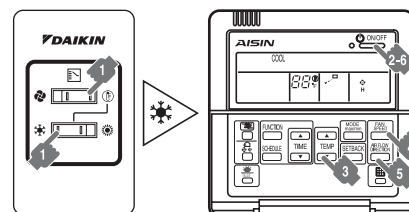

“☀” “⌚” Heating operation

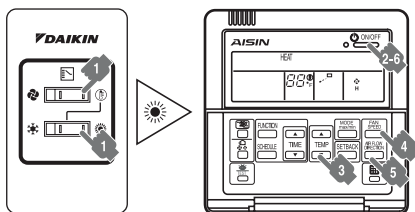

“🌀” Fan only operation

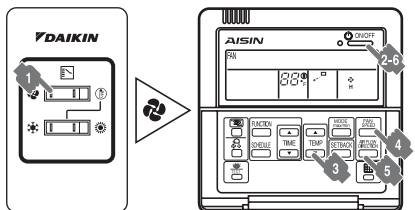

- 2 Press the on/off button.
The operation lamp lights up and the system starts operation.

Adjustment

To adjust the desired temperature, fan speed and air flow direction follow the procedure shown below.

- 3 Press the temperature setting button and program the desired temperature.



Each time this button is pressed, the temperature setting rises or lowers by 1°F.

— **NOTE** —

- Set the temperature within the operation range.
- The temperature setting is impossible for fan only operation.

- 4 Press the fan speed control button and select the fan speed of your preference.

- 5 Press air flow direction adjust button.
Refer to the chapter "4-3 ADJUSTING THE AIR FLOW DIRECTION" on page 12“.

Stopping the system

- 6 Press the on/off button once again.
The operation lamp goes off and the system stops operation.

— **CAUTION** —

Do not shut off the power immediately after turning the switch off.

The system requires at least 5 minutes to complete the draining process after turned off.



EXPLANATION OF HEATING OPERATION

- For general heating operation, it may take longer to reach the set temperature than in cooling operation.
We recommend preheating by setting the timer. For more details, refer to the Operation Manual attached to the remote controller.
- The following operations are performed in order to prevent the heating capacity from dropping or cold air from blowing.

Defrost operation

- In heating operation, the frost on heat exchanger surface of the outdoor unit increases. Heating capability decreases and the system goes into defrost operation.
- The indoor unit fan stops and the remote controller displays “STAND BY” (DEFROST/HOT START).
- After maximum 10 minutes of defrost operation, the system returns to heating operation again.

Hot start

- In order to prevent cold air from blowing out of an indoor unit at the start of heating operation, the indoor fan is automatically stopped. The display of the remote controller shows “STAND BY” (DEFROST/HOT START).

— **WARNING** —

Do not place appliances that produce open flames in places that are exposed to the air flow of the unit or under the indoor unit.

It may cause oxygen deficiency due to incomplete combustion or deformation of the unit due to the heat.



— **NOTE** —

- The heating capacity drops as the outside temperature falls. If this happens, use another heating device together with the unit. When using the appliances which produce open fire together, ventilate the room constantly.
- It takes some time for the room to warm up from the time the system operation is started since the unit uses a hot-air circulatory system to warm the entire room.

- If the hot air rises to the ceiling, leaving the area above the floor cold, we recommend using the circulator (the indoor fan for circulating air). Contact your dealer for details.

4-2 PROGRAM DRY OPERATION

- The function of this operation is to decrease the humidity in your room with a minimum temperature decrease.
- The micro computer automatically determines temperature and fan speed.
- This function is not available if the room temperature is 68°F or lower.

FOR SYSTEMS WITHOUT COOL/HEAT SELECTOR

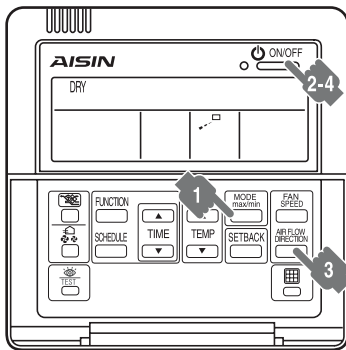

- 1 Press the operation mode selector button several times and select "DRY" (PROGRAM DRY operation).
- 2 Press the on/off button
The operation lamp lights up and the system starts operation.
- 3 Press the air flow direction adjust button. Refer to the chapter "4-3 ADJUSTING THE AIR FLOW DIRECTION" on page 12".
- 4 Press the on/off button once again.
The operation lamp goes off and the system stops operation.

CAUTION

Do not shut off the power immediately after turning the switch off.

The system requires at least 5 minutes to complete the draining process after turned off.

FOR SYSTEMS WITH COOL/HEAT SELECTOR

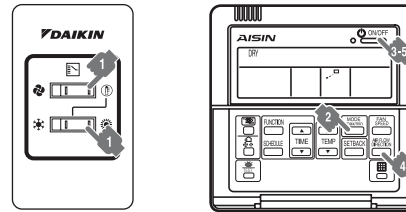

- 1 Select cooling operation mode with the COOL/HEAT selector.
- 2 Press the operation mode selector button several times and select "DRY" (PROGRAM DRY operation).
- 3 Press the on/off button
The operation lamp lights up and the system starts operation.
- 4 Press the air flow direction adjust button. Refer to the chapter "4-3 ADJUSTING THE AIR FLOW DIRECTION" on page 12".
- 5 Press the on/off button once again.
The operation lamp goes off and the system stops operation.

CAUTION

Do not shut off the power immediately after turning the switch off.

The system requires at least 5 minutes to complete the draining process after turned off.

4-3 ADJUSTING THE AIR FLOW DIRECTION

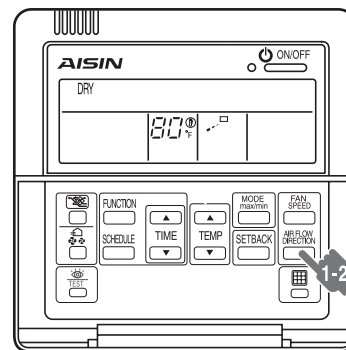

- 1 Press the air flow direction button to select the air direction.
The horizontal flap display swings as shown on the right and the air flow direction continuously varies. (Automatic swing setting)



- 2 Press the air flow direction adjust button to select the air direction of your choice.

The horizontal flap display stops swinging and the air flow direction is fixed. (Fixed air flow direction setting)

MOVEMENT OF THE HORIZONTAL FLAP

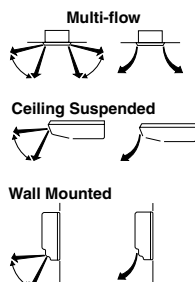

For the following conditions, a micro computer controls the air flow direction which may be different from the display.

COOLING	HEATING
	<ul style="list-style-type: none"> When starting operation. When the room temperature is higher than the set temperature. At defrost operation.
<ul style="list-style-type: none"> When operating continuously at horizontal air flow direction. When continuous operation with downward air flow is performed at the time of cooling with a ceiling-suspended or a wall-mounted unit, the microcomputer may control the flow direction, and then the remote controller indication also will change. 	

The air flow direction can be adjusted in one of the following ways.

- The horizontal flap itself adjusts its position.
- The air flow direction can be fixed by the user.
- Automatic “” and desired position “”.

NOTE

- The movable limit of the flap is changeable. Contact your dealer for details.
- Never operate in the horizontal direction “”. It may cause dew or dust to settle on the ceiling.

4-4 SETTING THE MAIN REMOTE CONTROLLER

- When the unit is installed as shown in figure below, it is necessary to designate one of the remote controllers as the main remote controller.

- When one outdoor unit is connected with several indoor units.

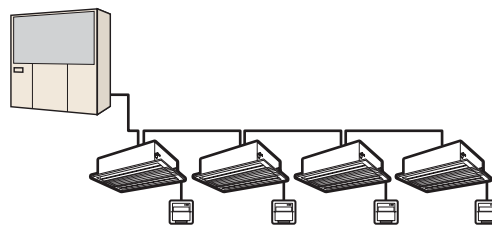

- Only the main remote controller can select heating, cooling operation.
- The displays of sub remote controllers show “” (CHANGEOVER UNDER CONTROL) and they automatically follow the operation mode directed by the main remote controller.

However, it is possible to changeover to program dry operation with sub remote controllers if the system is in cooling operation set by the main remote controller, and it is possible to changeover to fan only operation.

How to designate the main remote controller

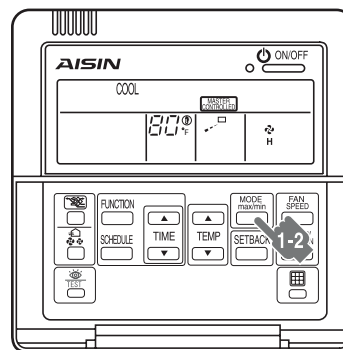

- 1 Press the operation mode selector button of the current main remote controller for 4 seconds.

The display showing “” (CHANGEOVER UNDER CONTROL) of all sub remote controllers connected to the same outdoor unit.

- 2 Press the operation mode selector button of the controller that you wish to designate as the main remote controller. Then designation is completed. This remote controller is designated as the main remote controller and the display showing “” (CHANGEOVER UNDER CONTROL) vanishes. The displays of other remote controllers show “” (CHANGEOVER UNDER CONTROL).

4-5 PRECAUTIONS FOR GROUP CONTROL SYSTEM OR 2 REMOTE CONTROLLER CONTROL SYSTEM

This system provides 2 other control systems besides individual control (1 remote controller controls 1 indoor unit) system. Confirm which of the following system applies to your unit.

- **Group control system**

One remote controller controls up to 16 indoor units. All indoor units are equally set.

- **Two remote controller control system**

Two remote controllers control 1 indoor unit (in case of group control system, 1 group of indoor units). The unit is individually operated.

— **NOTE** —

- Contact your dealer in case of changing the combination or setting of group control and two remote controller control systems.
-

5. OPTIMUM OPERATION

Observe the following precautions to ensure the system operates properly.

- Adjust the air outlet properly and avoid direct air flow to room inhabitants.
- Adjust the room temperature properly for a comfortable environment. Avoid excessive heating or cooling.
- Prevent direct sunlight from entering a room during cooling operation by using curtains or blinds.
- Ventilate often.
Extended use requires special attention to ventilation.
- Do not leave doors and windows open. If the doors and windows remain open, air will flow out of your room causing a decrease in the cooling or heating effect.
- Never place objects near the air inlet or the air outlet of the unit. It may cause deterioration in the effect or stop the operation.
- Turn off the main power supply switch to the unit when the unit is not used for longer periods of time. If the switch is on, it uses electricity. Before restarting the unit, turn on the main power supply switch 6 hours before operation to ensure smooth running.
- When the display shows “” (TIME TO CLEAN AIR FILTER), ask a qualified service person to clean the filters. (Refer to the chapter “Maintenance”

in the Maintenance Instruction attached to the indoor unit.)

- Keep the indoor unit and remote controller at least 3.5ft. away from televisions, radios, stereos, and other similar equipment.
Failure to do so may cause static or distorted pictures.
- Do not use other heating devices directly under the indoor unit.
Indoor units might get deformed by the heat.

6. RECOMMENDATION OF MAINTENANCE

To prevent unnecessary energy consumption while securing the safety and the comfortable use of air conditioner, the following actions are recommended if the unit (system) will not be used for an extended time.

6-1 BEFORE A SHUTDOWN IN EXCESS OF 1 MONTH

■ Check

- Are the indoor and outdoor unit intake and outlet vents blocked?
Remove anything that blocks them.
- Make sure that the exhaust vent or exhaust drain outlet of the outdoor unit are not blocked.

■ Clean the air filter and exterior.

- After cleaning the air filter, be sure to put it back in the same position.
See the Maintenance Instruction attached to the indoor unit for details on how to clean it.

■ Turn the power on.

- When the power comes on, the characters in the remote controller display appear.
(To protect the unit, turn the power on at least 6 hours before operating it. This makes operation smoother.)

■ Open the valve of the fuel gas.

6-2 WHEN RESTARTING THE UNIT FROM A SHUTDOWN

■ On a clear day, use fan operation for around half a day to thoroughly dry out the interior of the unit.

- Refer to the chapter "4-1 COOLING, HEATING AND FAN ONLY OPERATION" on page 10 for details on fan operation.

■ Clean the air filter and exterior.

- After cleaning the air filter, be sure to put it back in the same position.

See the Maintenance Instruction attached to the indoor unit for details on how to clean it.

■ **Close the valve of the fuel gas.**

■ **Turn off the power**

- When the power is shut off, the characters in the remote controller display disappear.
- When the power is turned on, indoor unit consumes several dozen watts of electricity. Be sure to turn the power off to conserve energy.

— **NOTE** —

- Contact your dealer if the error code “HF” (PERIODIC MAINTENANCE) is displayed on the remote controller.

7. ADDITIONAL ITEMS OF INFORMATION TO REVIEW

7-1 THE SYSTEM DOES NOT OPERATE

- **The system operation does not start immediately when restarting or changing the operation mode.**

If the operation lamp lights, the system is in normal condition.

To prevent overloading of the compressor, the system operation starts 5 minutes after it is turned ON again in case it was turned OFF just before.

- If “” (UNDER CENTRALIZED CONTROL) is displayed on the remote controller and pressing the operation button causes the display to blink for a few seconds.

This indicates that the central device is controlling the unit.

The blinking display indicates that the remote controller cannot be used.

- **The system does not start immediately after the power supply is turned on.**

Wait 5 minutes until the micro computer is prepared for operation.

7-2 IT STOPS SOMETIMES

- **The remote controller display shows “U4” or “U5” and stops but then restarts after a few minutes.**

This is because the remote control is intercepting noise from other electrical appliances, and this prevents communication between the units, causing them to stop.

Operation automatically restarts when the noise goes away.

7-3 COOL/HEAT CANNOT BE CHANGED OVER

- **When the display shows “” (CHANGEVER UNDER CONTROL).** It shows that this is a sub remote controller. Refer to the chapter "4-4 SETTING THE MAIN REMOTE CONTROLLER" on page 13.

- **When the COOL/HEAT selector is installed and the display shows “” (CHANGEVER UNDER CONTROL).**

This is because cool/heat changeover is controlled by the COOL/HEAT selector. Ask your dealer where the remote control switch is installed.

7-4 FAN OPERATION IS POSSIBLE, BUT COOLING AND HEATING DO NOT WORK

- **Immediately after the power is turned on.** The micro computer is getting ready to operate. Wait 5 minutes.

7-5 THE FAN STRENGTH DOES NOT CORRESPOND TO THE SETTING

- **The fan speed does not change even if the fan speed control button is pressed.** During heating operation, when the room temperature reaches the set temperature, the outdoor unit goes off and the indoor unit changes to whisper the fan speed. This is to prevent cold air blowing directly on occupants of the room. The fan speed will not change even if the button is pressed, when another indoor unit is in heating operation.

7-6 THE FAN DIRECTION DOES NOT CORRESPOND TO THE SETTING

- **The fan direction does not correspond to the remote controller display.** **The fan direction does not swing.** This is because the unit is being controlled by the micro computer. Refer to the chapter "4-3 ADJUSTING THE AIR FLOW DIRECTION" on page 12.

7-7 WHITE MIST COMES OUT OF THE UNIT

■ **Indoor unit**

- **When humidity is high during cooling operation.** If the interior of indoor unit is extremely contaminated, the temperature distribution inside a room becomes uneven. It is necessary to clean the interior of indoor unit. Ask your dealer for details

on cleaning the unit. This operation requires a qualified service person.

- **Immediately after the cooling operation stops when the room temperature and humidity are low.**

This is because warm refrigerant vapor flows back into the indoor unit and generates steam.

■ Indoor unit, outdoor unit

- **When the system is changed over to heating operation after defrost operation.**

Moisture generated by defrost becomes steam and is exhausted.

7-8 NOISE OF THE UNITS

■ Indoor unit

- **A “zeen” sound is heard immediately after the power supply is turned on.**

The electronic expansion valve inside the indoor unit starts working and makes the noise. Its volume will reduce in about 1 minute.

- **A continuous low “shah” sound is heard when the system is in cooling operation or at a stop.**

When the drain pump (an optional accessory) is in operation, this noise is heard.

- **A “pishi-pishi” squeaking sound is heard when the system stops after heating operation.**

Expansion and contraction of plastic parts caused by temperature change make this noise.

- **A low “sah”, “choro-choro” sound is heard while the indoor unit is stopped.**

When the other indoor unit is in operation, this noise is heard. In order to prevent oil and refrigerant from remaining in the unit, a small amount of refrigerant is kept flowing.

■ Outdoor unit

- **When the tone of operating noise changes.**

This noise is caused by the change of engine speed.

■ Indoor unit, outdoor unit

- **A continuous low hissing sound is heard when the system is in cooling or defrost operation.**

This is the sound of refrigerant gas flowing through both indoor and outdoor units.

- **A hissing sound which is heard at the start or immediately after stopping operation or defrost operation.**

This is the noise of refrigerant caused by flow stop or flow change.

7-9 DUST COMES OUT OF THE UNIT

- **When the unit is used after stopping for a long time.**

This is because dust has gotten into the unit.

7-10 THE UNITS GIVE OFF ODORS

- **The unit can absorb the smell of rooms, furniture, cigarettes, etc., and then emit it again.**

7-11 THE OUTDOOR UNIT FAN DOES NOT ROTATE

- **During operation.**

The speed of the fan is controlled in order to optimize product operation.

7-12 THE DISPLAY SHOWS “88”

- **This is the case immediately after the main power supply switch is turned on and means that the remote controller is in normal condition. This continues for 1 minute.**

7-13 THE COMPRESSOR OR FAN IN THE OUTDOOR UNIT DOES NOT STOP

- **This is to prevent oil and refrigerant from remaining in the compressor. The unit will stop after 5 to 10 minutes.**

7-14 THE INSIDE OF OUTDOOR UNIT IS WARM EVEN WHEN THE UNIT HAS STOPPED

- **This is because the crankcase heater is warming the compressor so that the compressor can start smoothly.**

7-15 HOT AIR IS EMITTED EVEN THOUGH THE UNIT IS STOPPED

- **Hot air can be felt when the unit is stopped.**

Several different indoor units are being run on the same system, so if another unit is running, some refrigerant will still flow through the unit.

7-16 DOES NOT COOL VERY WELL

- **Program dry operation.**

Program dry operation is designed to lower the room temperature as little as possible.

Refer to the chapter "4-2 PROGRAM DRY OPERATION" on page 12.

8. TROUBLE SHOOTING

If one of the following malfunctions occurs, take the measures shown below and contact your dealer.

⚠ DANGER

Stop operation, turn off the power and contact your dealer immediately when any abnormalities are noticed during operation. (burning smells, smoke, etc.) 

Leaving the unit running under such circumstances may damage the unit, or result in electrical shock or a fire.

- If a safety device such as a fuse, a breaker or a ground fault circuit breaker frequently actuates;
Action: Do not turn on the main power switch.
- If the ON/OFF switch does not properly work;
Action: Immediately turn off the main power switch.
- If water leaks from unit;
Action: Immediately stop the operation.
- The operation mode selector button does not work well.
Action: Immediately turn off the power.
- If the display “”, the unit number and the operation lamp flash and the error code appears;

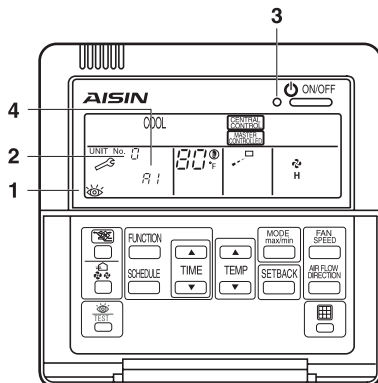

1. Inspection display
2. Indoor unit number in which a malfunction occurs
3. Operation lamp
4. Error code

Action: Notify your dealer and report the malfunction code.

If the system does not properly operate except for the above mentioned cases and none of the above mentioned malfunctions is evident, investigate the system according to the following procedures.

If it is not possible to fix the problem yourself after checking all the above items, contact your dealer.

Let the dealer know of the symptoms, system name, and model name.

1. If the system does not operate at all;
 - Check if there is a power failure.
Wait until power is restored. If power failure occurs during operation, the system automatically restarts immediately after the power supply is recovered.
 - Check if a fuse has blown or a breaker has tripped.
Turn off the power supply.

- Is the breaker down?

Turn the power on with the breaker switch in the off position.

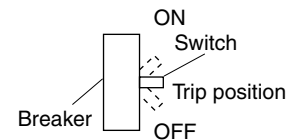

Do not turn the power on with the breaker switch in the trip position.

2. If the system goes into fan only operation, but as soon as it goes into heating or cooling operation, the system stops;
 - Check if air inlet or outlet of outdoor or indoor unit is blocked by obstacles.
Remove any obstacle and make it well-ventilated.
 - Check if the remote controller display shows “” (TIME TO CLEAN AIR FILTER). (Refer to the chapter “Maintenance” in the Maintenance Instruction attached to the indoor unit.)
3. The system operates but cooling or heating is insufficient;
 - Check if air inlet or outlet of outdoor or indoor unit is blocked by obstacles.
Remove any obstacle and make it well-ventilated.
 - Check if the air filter is not clogged. (Refer to the chapter “Maintenance” in the Maintenance Instruction attached to the indoor unit.)
 - Check the temperature setting.
 - Check the fan speed setting on your remote controller.
 - Check for open doors or windows. Shut doors and windows to prevent wind from coming in.
 - Check if there are too many occupants in the room during cooling operation.
 - Check if the heat source of the room is excessive.
 - Check if direct sunlight enters the room.
Use curtains or blinds.
 - Check if the air flow angle is not proper.



9. ERROR CODE LIST

Error code	Description
A0	I.U., External protection activation
A1	I.U., Control board assy EEPROM setting error
A3	I.U., Abnormal drain water level
A6	I.U., Fan lock
A7	I.U., Wind direction control motor failure
A9	I.U., Electronic expansion valve driving part failure
AF	I.U., Drain failure
AH	I.U., Indoor dust extractor failure
AJ	I.U., Indoor unit capacity setting error
C4	I.U., Heat exchanger liquid pipe sensor failure
C5	I.U., Heat exchanger vapor pipe sensor failure
C9	I.U., Indoor intake air temperature sensor failure
CA	I.U., Indoor discharge air temperature sensor failure
CJ	I.U., Remote controller sensor failure
U0	O.U., Refrigerant empty
U0	O.U., Refrigerant insufficient
U1	Open phase in a three phase power supply
U1	O.U., Incorrect connection in single phase power supply
U3	O.U., Test run is not done
U4	I.U. - O.U.>, Transmission failure
-	I.U. - O.U.>, Transmission failure
U5	RC - I.U.>, Transmission failure
U5	RC circuit board failure RC setting error
U7	Transmission error between outdoor units 1
U7	Transmission error between outdoor units 2
U7	Transmission error between outdoor units 3
U7	Transmission error between outdoor units 4
U7	Transmission error between outdoor units 5
U7	Transmission error between outdoor units 6
U7	Transmission error between outdoor units 7
U8	Main-sub RCs transmission error (Sub-RC failure)
U9	I.U. - O.U.>, Transmission failure
U9	Transmission error between another indoor unit and outdoor unit within same system
UA	Excess indoor units connected
UA	Incorrect I.U./O.U. combination (model/number etc.)
UC	Centralized address No. duplication
UE	I.U. - centralized RC transmission failure

UF	System unset/incorrect wiring
UH	System failure
E1	O.U., EEPROM failure
E1	O.U., EEPROM model code failure
E1	O.U., Programming unmatched
E1	O.U., Main-engine microcomputer transmission failure
E1	O.U., I/F main microcomputer transmission failure
E3	O.U., Refrigerant high pressure failure 2
E3	O.U., Refrigerant high pressure failure 1
E4	O.U., Refrigerant low pressure failure
E7	O.U., All fan motor failure
E7	O.U., Fan motor 1 starting failure
E7	O.U., Fan motor 2 starting failure
E7	O.U., Fan motor 3 starting failure
E7	O.U., Fan motor 1 revolution failure
E7	O.U., Fan motor 2 revolution failure
E7	O.U., Fan motor 3 revolution failure
EA	O.U., Four-way changeover valve switching failure
EC	O.U., Over-heated engine coolant temperature
EH	O.U., Coolant pump starting failure
EH	O.U., Coolant pump revolution failure
EH	O.U., IPM error
F3	O.U., Over-heated compressor discharge temperature
F4	O.U., Over-heated compressor intake temperature
F4	O.U., Insufficient compressor intake superheating degree
FE	O.U., Engine oil pressure error
FF	O.U., Refrigerant oil empty
FJ	O.U., Exhaust air temperature abnormality
H3	O.U., High pressure switch open circuit
H4	O.U., Low pressure switch open circuit
H9	O.U., Outside temperature sensor open circuit
H9	O.U., Outside temperature sensor short circuit
HC	O.U., Coolant temperature sensor open circuit
HC	O.U., Coolant temperature sensor short circuit
HJ	O.U., Coolant empty
HF	O.U., Periodic maintenance
J3	O.U., Compressor discharge temperature sensor 1 open circuit
J3	O.U., Compressor discharge temperature sensor 2 open circuit
J3	O.U., Compressor discharge temperature sensor 3 open circuit
J3	O.U., Compressor discharge temperature sensor 4 open circuit

J3	O.U., Compressor discharge temperature sensor 1 short circuit
J3	O.U., Compressor discharge temperature sensor 2 short circuit
J3	O.U., Compressor discharge temperature sensor 3 short circuit
J3	O.U., Compressor discharge temperature sensor 4 short circuit
J4	O.U., Supercool heat exchanger inlet temperature sensor short circuit
J4	O.U., Supercool heat exchanger inlet temperature sensor open circuit
J4	O.U., Accumulator outlet temperature sensor 1 open circuit
J4	O.U., Accumulator outlet temperature sensor 2 open circuit
J4	O.U., Accumulator outlet temperature sensor 1 short circuit
J4	O.U., Accumulator outlet temperature sensor 2 short circuit
J5	O.U., Compressor intake temperature sensor 1 open circuit
J5	O.U., Compressor intake temperature sensor 2 open circuit
J5	O.U., Compressor intake temperature sensor 1 short circuit
J5	O.U., Compressor intake temperature sensor 2 short circuit
J6	O.U., Heat exchanger liquid temperature sensor open circuit
J6	O.U., Heat exchanger liquid temperature sensor short circuit
J7	O.U., Sub heat exchanger outlet temperature sensor open circuit
J7	O.U., Sub heat exchanger outlet temperature sensor short circuit
J8	O.U., Liquid pipe temperature sensor open circuit
J8	O.U., Liquid pipe temperature sensor short circuit
JA	O.U., High pressure sensor failure 1
JA	O.U., High pressure sensor failure 2
JC	O.U., Refrigerant low pressure sensor failure
JE	O.U., Engine oil pressure switch open circuit
JJ	O.U., Engine room temperature sensor open circuit
JJ	O.U., Engine room temperature sensor short circuit
JJ	O.U., Exhaust temperature sensor open circuit
LE	O.U., Igniter voltage too low
LE	O.U., Igniter open circuit
LE	O.U., Igniter voltage too high
LF	O.U., Engine starting failure
LJ	O.U., Engine stop
P8	O.U., Engine revolution control failure
P8	O.U., Lower engine revolution when starting
P8	O.U., Engine revolution hunting error
P8	O.U., Excessive engine revolution 1
P8	O.U., Excessive engine revolution 2
PE	O.U., Output failure of gas electromagnetic valve
PF	O.U., Unintended starter operation

— NOTE

- White section indicates the trouble in the result (check/alarm). Be sure to check and repair, though system may be operated without displaying “” or “.

10. WARRANTIES AND LIABILITIES

10-1 Your warranty

This system is warranted by your dealer or distributor, and not by Aisin Seiki CO., LTD or any of its affiliated companies, including but not limited to Aisin World Corp. of America (“AISIN”) except for emission control-related warranty claim defined on "EPA EMISSION CONTROL WARRANTY STATEMENT".

AISIN MAKES NO EXPRESS OR IMPLIED WARRANTIES ON THIS SYSTEM, AND SPECIFICALLY DISCLAIMS ANY IMPLIED WARRANTIES OF MERCHANTABILITY OR FITNESS FOR PARTICULAR PURPOSE.

10-2 AISIN’s liabilities

AISIN WILL IN NO EVENT BE LIABLE FOR ANY INCIDENTAL OR CONSEQUENTIAL DAMAGES IN CONNECTION WITH THIS SYSTEM, WHETHER FOR BREACH OF WARRANTY ANY OTHER BREACH OF CONTRACT, NEGLIGENCE OR OTHER TORT, OR ON ANY STRICT LIABILITY THEORY.

11. AFTER SALE SERVICE

11-1 Things to check before requesting the repair service

Please have the following information ready before you call:

- Model name of the outdoor unit
- Serial number of the outdoor unit
- Detailed description of your problem along with the “error code” on the remote controller
- Address, Name of customer, Phone number

11-2 Periodic maintenance

To ensure the unit continues to operate in a reliable manner for a long period of time, periodic maintenance must be done by an authorized service provider (at a charge). Contact the dealer for more details about the installation and maintenance.

11-3 Moving or discarding the unit

The removal, reinstallation or discarding of the unit must be completed by an authorized service provider. Contact the dealer for more details.

EPA EMISSION CONTROL WARRANTY STATEMENT YOUR WARRANTY RIGHTS AND OBLIGATIONS

The Environmental Protection Agency (EPA) are pleased to explain the emission control system warranty on your 2012 Model Year non-road Spark-Ignition (SI) engine. New non-road SI engines must be designed, built and equipped to meet stringent anti-smog standards in all 50 states. AISIN must warrant the emission control system on your engine for the periods of time listed below provided there has been no abuse, neglect or improper maintenance of your engine.

WARRANTY COVERAGE:

Model Year 2012 non-road SI engines are warranted for 2 years or 5,000 hours, whichever occurs first, to be free of defects in material or workmanship of any emission related part, unless indicated otherwise.

If any emission-related part on your engine is defective, the part will be repaired or replaced. Your emission control system may include parts such as the Natural Gas mixer and regulator, ignition system, engine control system. Also included may be sensors, hoses, connectors, and other emission-related assemblies. The following list of parts defines the "emission-related" parts

- | | |
|--|--|
| 1) Air-Induction System | 5) Ignition Control System |
| a) Intake Manifold | a) Spark Plug |
| | b) Ignition Coil |
| | c) Ignition Module |
| 2) Exhaust Manifold | |
| 3) Fuel System | 6) Positive Crankcase Ventilation System |
| a) Gas Mixer (Include Throttle Valve and Fuel Control Valve) | (-Without PCV Valve) |
| b) Gas Regulator | |
| 4) Electronic Control System | a) Hoses, Clamps, Fittings, Tubing |
| a) ECU | b) Gaskets, Seals |
| b) Engine Speed / Timing Sensor | c) AISIN supplied engine Wiring Harnesses |
| c) Coolant Temperature Sensor | d) AISIN supplied engine Elec. Connectors |
| d) Oil Pressure Sensor | e) Air Cleaner Element, Oil Filter Element |

Where a warrantable condition exists, AISIN will repair your engine at no cost to you including diagnosis, parts and labor.

OWNER'S WARRANTY RESPONSIBILITIES:

- As the non-road SI engine owner, you are responsible for the performance of the required maintenance designated by AISIN. AISIN recommends that you retain all receipts covering maintenance on your engine, but AISIN cannot deny warranty solely for the lack of receipts or your failure to ensure the performance of all scheduled maintenance.
- As the non-road SI engine owner, you should, however, be aware that AISIN may deny your warranty coverage if your engine or a part has failed due to tampering, abuse, neglect, improper maintenance or unapproved modifications to the engine or fuel control system.
- Your engine is designed to operate on natural gas as applicable. To confirm the fuel(s) this engine is capable of operating on, see the Emission Control Information label located on the rear cover of the outdoor unit.
- Natural gas engines and fuel systems are designed to operate on natural gas fuel. Fuel other than natural gas fuel may cause harm to the engine's emission control system and a warranty claim may be denied. Use of any other fuel may result in your engine no longer operating in compliance with EPA emissions requirements.
- The high heating value of natural gas should be in the range between 1,000BTU and 1,200BTU. In case natural gas has the specification lower than the above-mentioned value, the non-road SI engine may stall or have some defect.
- You are responsible for initiating the warranty process. EPA suggests that you present your engine to an AISIN authorized dealer as soon as a problem exists. The warranty repairs should be completed by the dealer as expeditiously as possible.

ITEMS NOT COVERED UNDER THIS WARRANTY

The following items are not covered under the AISIN warranty:

- Repairs as a result of improper maintenance or use
- Repairs made by unauthorized technicians, service stations, or dealers

Repair parts are available from INTELLICHIOCE ENERGY, Aisin's authorized dealer.

If you have any questions regarding your warranty rights and responsibilities, you should contact INTELLICHIOCE ENERGY at 888-359-6675- 2355 W. Utopia Road, Phoenix, AZ 85027. E-mail: info@iceghp.com - , 01/01/2012

Distributed by:

AISIN WORLD CORP OF AMERICA, INC

46501 Commerce Center Drive,
Plymouth, MI 48170
U.S.A.



※ It is firmly prohibited to copy, distribute, reproduce, and transmit publicly (including making it electronically available) any of the contents of this manual without permission.