

Always read the instructions before use

YOSHI[®] AWS D3 Yoshi Air Water System

SERVICE MANUAL 8-10-13-16-20-25 HP

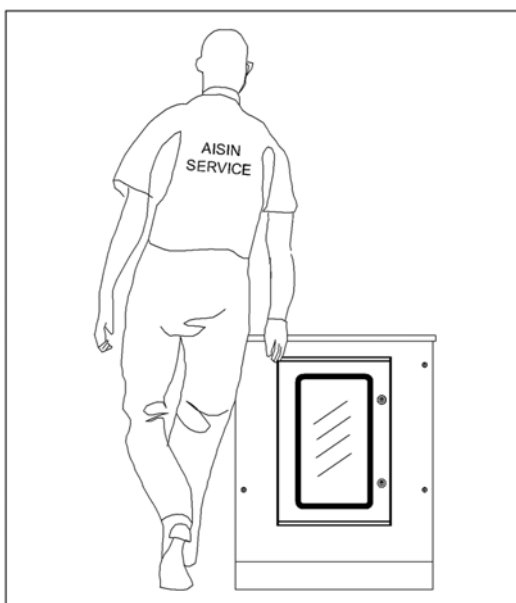

Safety Precautions

The following safety warnings need to be respected in order to prevent injury and/or damage that might be caused by incorrect behavior during repairs, inspections or maintenance to the Yoshi AWS Air Water System. Please read this manual with care and follow the instructions it contains.



CAUTION

Failure to abide by the instructions indicated with this symbol could cause serious damage to people or property.



Before commencing an inspection

1. Disconnect the power to the external control box of the YOSHI AWS to prevent the risk of electric shocks;
2. After disconnecting the current, wait for at least one minute to allow any residual electricity to dissipate.

Tecnocasa s.r.l. declines any responsibility for any damage whatsoever caused through the partial or superficial reading of the information in this manual. The drawings and information in this manual may change without notice.

CONTENTS

1	AWS identification	65
	Electrical and water connections GHP-AWS	66
3	AWS unit specifications.....	67
4	Dimensions	69
5	Refrigerant system operating	70
5.1	<i>Cooling mode</i>	70
5.2	<i>Heating mode</i>	70
6	Control panel.....	72
6.1	<i>Using the control panel selection keypad</i>	72
6.2	<i>Key functions</i>	72
6.3	<i>Control panel root directory</i>	73
7	Switching the Yoshi AWS ducted unit on/off	74
8	Language selection	75
9	Menu	78
10	User mode.....	79
10.1	<i>Date and time menu</i>	80
10.2	<i>Heating/cooling mode settings (user mode menu)</i>	81
11	Programming operating times	82
11.1	<i>Timer programming menu</i>	82
11.2	<i>Timer setting</i>	83
11.3	<i>Time interval setting</i>	83
12	Setting the set point temperature	85
12.1	<i>T set heat (heating)</i>	85
12.2	<i>T set cool (cooling)</i>	86
13	Alarms	87
13.1	<i>Alarms menu</i>	87
13.2	<i>Alarms history menu</i>	88
13.3	<i>Alarms reset menu</i>	89
13.4	<i>AWS alarms list</i>	89
13.5	<i>GHP outdoor unit alarms list</i>	90
14	Service mode menu	92
14.1	<i>I/O menu (AWS input and output signals)</i>	93
14.1.1	<i>Analog input menu</i>	93
14.1.2	<i>Digital input menu</i>	95
14.1.3	<i>Digital outputs menu</i>	98

14.2	<i>Pump control</i>	100
14.3	<i>Mode selection</i>	101
14.4	<i>Toffset cooling</i>	101
14.5	<i>Toffset heating</i>	101
14.6	<i>Pump delay</i>	102
15	Disabling the flow switch alarm	103
16	Wiring diagrams	106
17	Relation between engine RPM and outside temperature.....	112
18	Contact specifications	118
19	Table temperature – sensor NTC resistor	119
20	Characteristics sensor gas and liquid pipe.....	120

1 AWS identification

Each AWS YOSHI can is traceable by model name and serial number. Aisin's authorized service center is requested to store this information and to write it down at the commissioning in the maintenance booklet.

- Serial number is an alpha-numerical code that allows to retrieve information about the specifications of the unit.

UNIT	CAPACITY	SERIES	VERSION	PUMP
AWS	20 HP	D	3	J
	Shows the capacity of the GHP to be connected	Shows the series of the GHP to be connected	Shows the type of the AWS minor change	Shows whether the unit has a built in pump or not

- Model name is an alpha-numerical number that shows capacity and series of each unit.

Electronics	Heat exchanger type	Electric box type	Version	Expansion valve type	Pump type	Capacity	Serial number				
D	S	L	6	C	V	X	0	0	5	2	6
AISIN DAIKIN	S: Swep O: Onda	L: Picchio E: Electron C: Castellani H: Stacchiotti		C: Carel E: Eliwell	N: Salmson V: Wilo J: No pompa	X: 8-10-13 HP W: 16-20-25 HP	This is a one-time used number. The same number can never be addressed to more than one unit.				

2 Electrical and water connections GHP-AWS

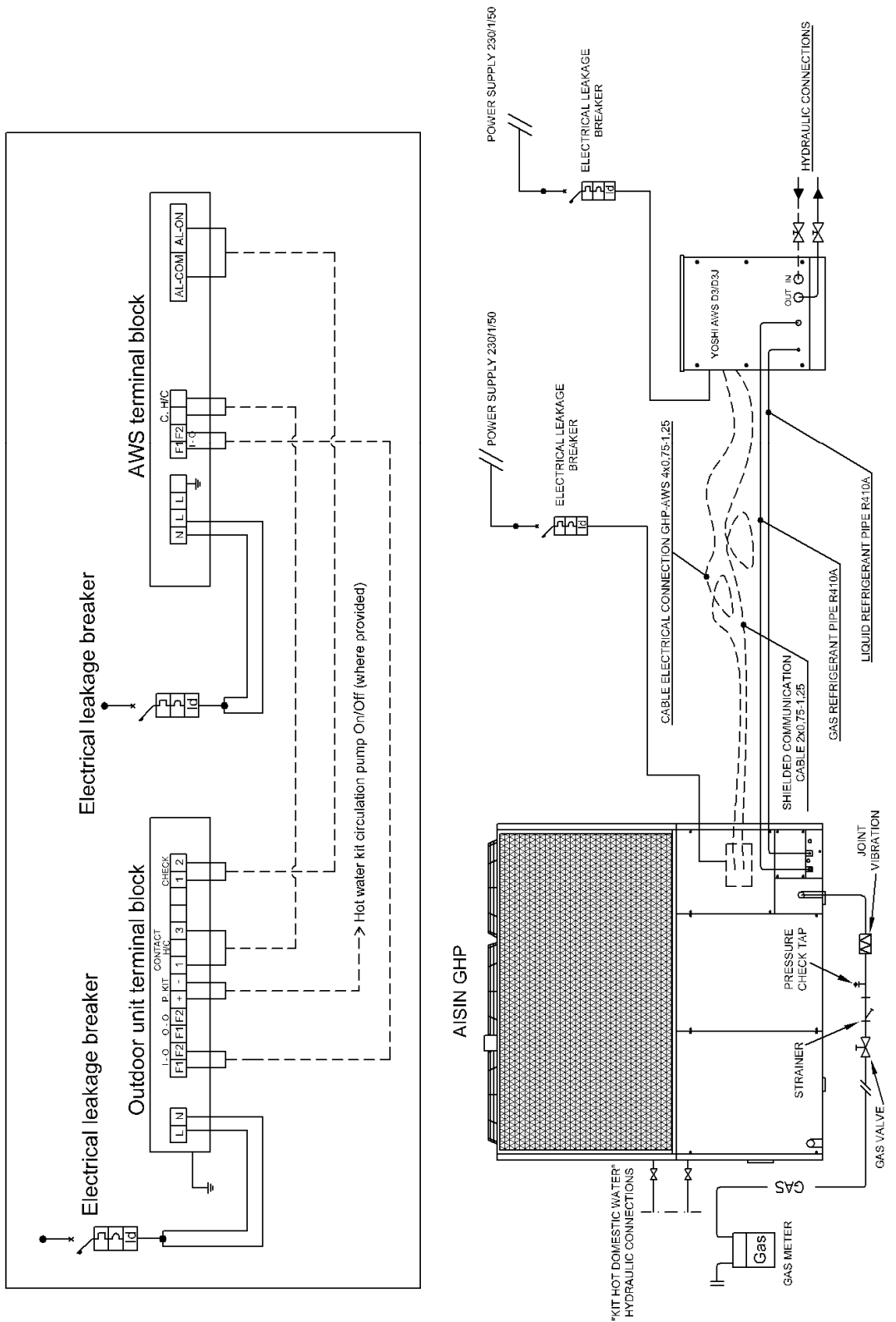

3 AWS unit specifications

All versions		AWS 8HP-D3 (D3J)	AWS 10HP-D3 (D3J)	AWS 13HP-D3
Capacity code of the connected GHP outdoor unit		P224	P280	P355
Rated cooling capacity*	kW (frig./h)	21,5 (18.490)	26,6 (22.876)	34,0 (29.240)
Water temperature out - [in]	°C	7 – [11]	7 – [12]	7 – [12]
Rated heating capacity **	kW (kcal/h)	23,5 (20.210)	30,0 (25.800)	38,0 (32.680)
Water temperature out - [in]	°C	45,5 – [41]	45,5 – [40]	45,5 – [40]
Flow rate	m ³ /h	4,5	4,5	6,0
Version with Pump (AWS D3)	Power supply***	V/Ph/Hz	230/1/50	
	Power consumption	kW	0,83	
	Available static pressure	kPa	80	80
Version without Pump (AWS D3J)	Power supply	V/Ph/Hz	230/1/50	
	Maximum current	A	10	
Drop pressure plate heat exchanger	m.c.a.	3,3	3,3	4,6
Water circuit	Water pipes connection	Inch	2 (Each AWS unit is delivered with 2" nipples fittings to be installed if necessary)	
	Primary circuit pipes diameter	Inch	2 or higher (Each AWS unit is fitted with a 2" Y-shape filter to be installed on the primary circuit)	
Refrigerant circuit	Refrigerant gas connection (gas – liquid)	mm	28,6 – 12,7	
	GHP – AWS pipes diameter (gas – liquid)	mm	19,1 – 9,5 **** (12,7)	22,2 – 9,5 **** (12,7)
External dimensions and weight	Height	mm	915	
	Width	mm	710	
	Depth	mm	1020	
	With Pump/Without Pump	kg	164/153	
Connectable GHP outdoor units		Each AWS unit can be connected with a single AISIN GHP outdoor unit		

* Rated cooling capacity is measured according to the following conditions: water outlet temperature 7°C; outdoor temperature 35°C DB

** Rated heating capacity is measured according to the following conditions: water outlet temperature 47°C; outdoor temperature 7°C DB / 6°C WB

*** A version fitted with 230V, single phase, 60 Hz is available upon order.

**** If the distance between GHP and AWS exceeds 40 meters, increasing the size of the liquid pipe with a more larger diameter.

All versions		AWS 8HP-D3 (D3J)	AWS 10HP-D3 (D3J)	AWS 13HP-D3
Capacity code of the connected GHP outdoor unit		P224	P280	P355
Rated cooling capacity*	kW (frig./h)	43,0 (36.980)	53,5 (46.010)	67,5 (58.050)
Water temperature out - [in]	°C	7 – [12]	7 – [12]	7 – [12]
Rated heating capacity **	kW (kcal/h)	47,5 (40.850)	60,0 (51.600)	76,0 (65.360)
Water temperature out - [in]	°C	45,5 – [40]	45,5 – [40]	45,5 – [40]
Flow rate	m ³ /h	7,5	9,5	12
Version with Pump (AWS D3)	Power supply***	V/Ph/Hz	230/1/50	
	Power consumption	kW	1.3	
	Available static pressure	kPa.	100	80
Version without Pump (AWS D3J)	Power supply	V/Ph/Hz	230/1/50	
	Maximum current	A	10	
Drop pressure plate heat exchanger	m.c.a.	2,2	3,3	4,6
Water circuit	Water pipes connection	Inch	2 (Each AWS unit is delivered with 2" nipples fittings to be installed if necessary)	
	Primary circuit pipes diameter	Inch	2 or higher (Each AWS unit is fitted with a 2" Y-shape filter to be installed on the primary circuit)	
Refrigerant circuit	Refrigerant gas connection (gas – liquid)	mm	28,6 – 18,0	
	GHP – AWS pipes diameter (gas – liquid)	mm	28,6 – 12,7 **** (15,88)	28,6 – 15,88 **** (19,05)
External dimensions and weight	Height	mm	915	
	Width	mm	710	
	Depth	mm	1020	
	With Pump/Without Pump	kg	204/177	
Connectable GHP outdoor units		Each AWS unit can be connected with a single AISIN GHP outdoor unit		

* Rated cooling capacity is measured according to the following conditions: water outlet temperature 7°C; outdoor temperature 35°C DB

** Rated heating capacity is measured according to the following conditions: water outlet temperature 47°C; outdoor temperature 7°C DB / 6°C WB

*** A version fitted with 230V, single phase, 60 Hz is available upon order.

**** If the distance between GHP and AWS exceeds 40 meters, increasing the size of the liquid pipe with a more larger diameter.

4 Dimensions

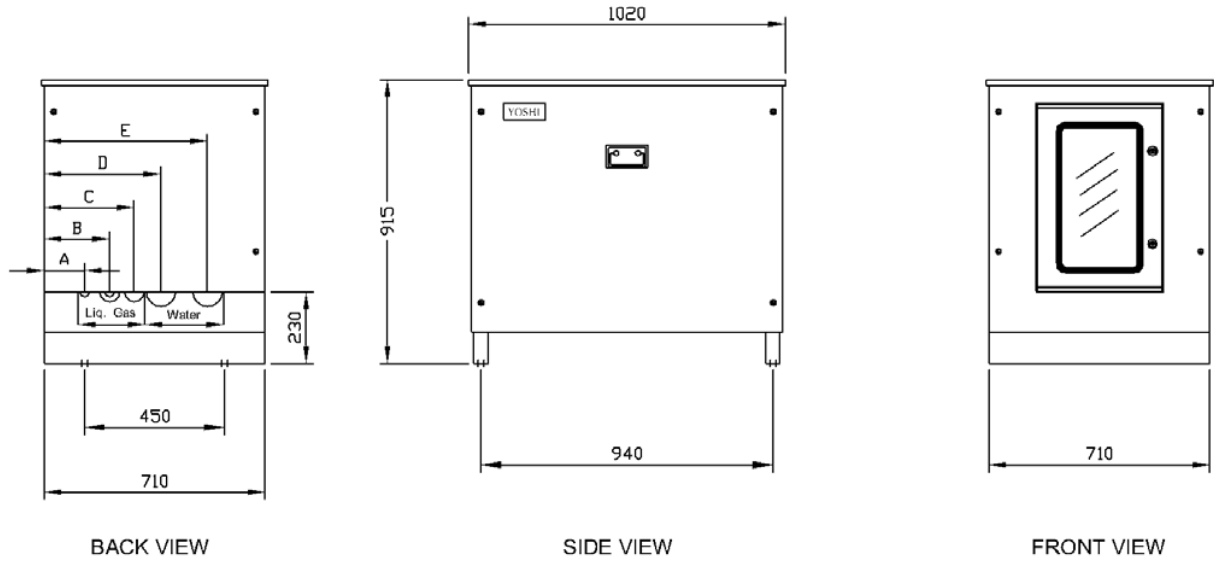

SPECIFICATIONS													
Water pipes connection	Inch	ϕ 2											
Primary circuit water pipes	Inch	ϕ 2 or higher											
Refrigerant gas connection	mm	(8 – 10 – 13) HP						(16 – 20 – 25) HP					
		Liquid			Gas			Liquid		Gas			
		12,7			28,6			18,0		28,6			
GHP – AWS Refrigerant gas line	mm	8 HP		10 HP		13 HP		16 HP		20 HP		25 HP	
		Liq.	Gas	Liq.	Gas	Liq.	Gas	Liq.	Gas	Liq.	Gas	Liq.	Gas
		9,5	19,1	9,5	22,2	12,7	25,4	12,7	28,6	15,9	28,6	15,9	35
Refrigerant and hydraulic pipes connection positions		Liquid (16-20-25)HP			Liquid (8-10-13) HP Gas (16-20-25) HP			Gas (8-10-13) HP		Water (8-10-13) HP Water (16-20-25) HP		Water (8-10-13) HP Water (16-20-25) HP	
		A			B			C		D		E	
	mm	130			210			290		375		525	
Dimensions (H x W x D)	mm	710 / 915 / 1020											

5 Refrigerant system operating

5.1 Cooling mode

The refrigerant (R410A) processed by the GHP flows through electronic expansion valve and enters the lower part of the AWS unit heat exchanger at low pressure. The gas evaporates in the plate heat exchanger by taking heat from the counter current water flow. It goes back to the GHP as overheated steam. The outdoor unit fans create an air flow through the heat exchanger and thus the refrigerant can condense.

At the same time, the water coming from the buffer tank is cooled and pumped again into the primary circuit by the AWS built in pump. Flow switch, pressure switch and anti freeze thermo sensor overlook the water temperature never to drop inside the heat exchanger. In fact, water may freeze and the heat exchanger can be damaged.

5.2 Heating mode

The refrigerant (R410A) processed by the GHP enters the upper part of the AWS unit heat exchanger as high pressure overheated steam. The gas condenses in the plate heat exchanger by ceasing heat to the co current water flow. It goes back to the GHP as high pressure liquid, through the bypass pipe. The two outdoor unit expansion valves divide the return flow, reducing its pressure. The GHP manages the evaporation through the heat exchanger and the heat recovery.

At the same time, the water coming from the buffer tank is heated and pumped again into the primary circuit by the AWS built in pump.

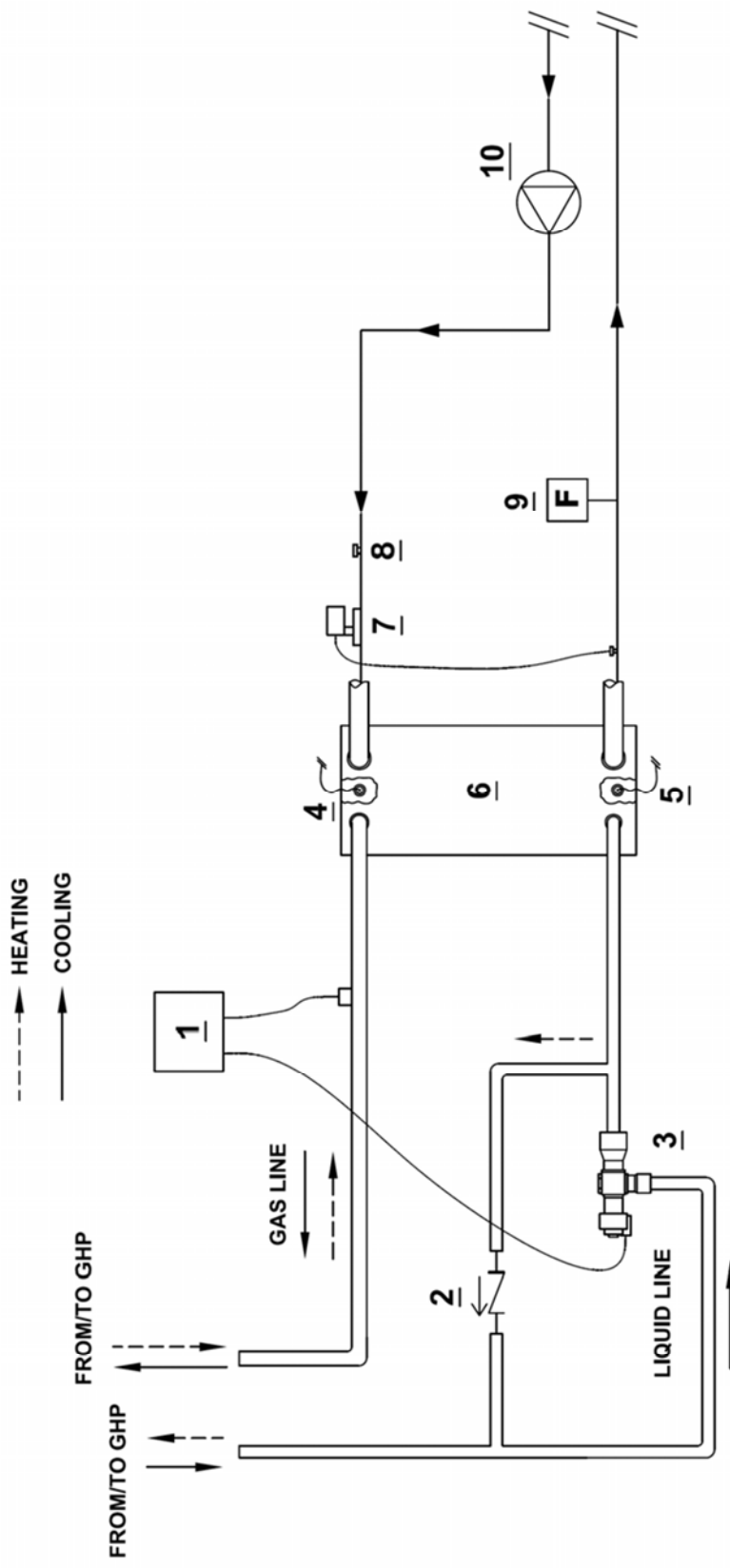

- 1) PID Controller
- 2) Check valve
- 3) Electronic expansion valve
- 4) Water inlet temperature probe
- 5) Water outlet temperature probe
- 6) Plate heat exchanger
- 7) Pressure difference switch
- 8) Air vent valve
- 9) Flow switch
- 10) Pump

6 Control panel

The YOSHI AWS has a control panel for adjustment and control, installed inside the control box and illustrated in the figure below.

The user has the possibility to select some options concerning the operation of the YOSHI AWS and to check the type of any anomalies.

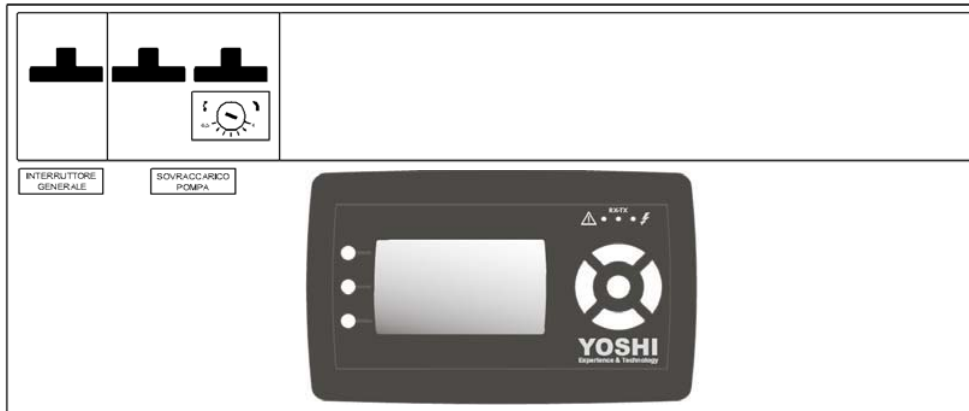

6.1 Using the control panel selection keypad

To navigate inside the menu, use the following selection keypad

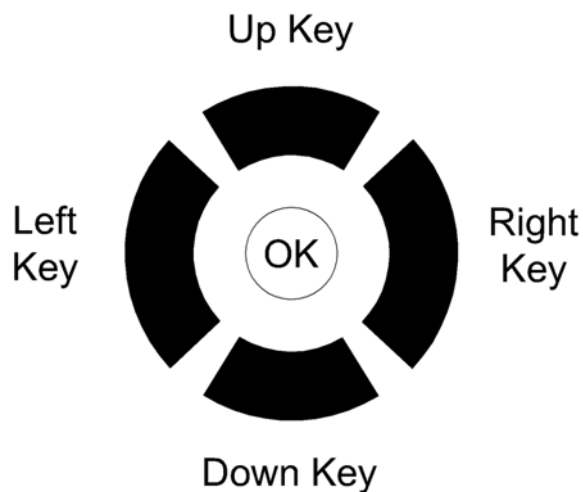

6.2 Key functions

Use the “Up” and “Down” keys to scroll through the list of options on the menu.

The “OK” button is used to select the required function and to confirm settings. The “Right” and “Left” keys are used to exit the selected mode.

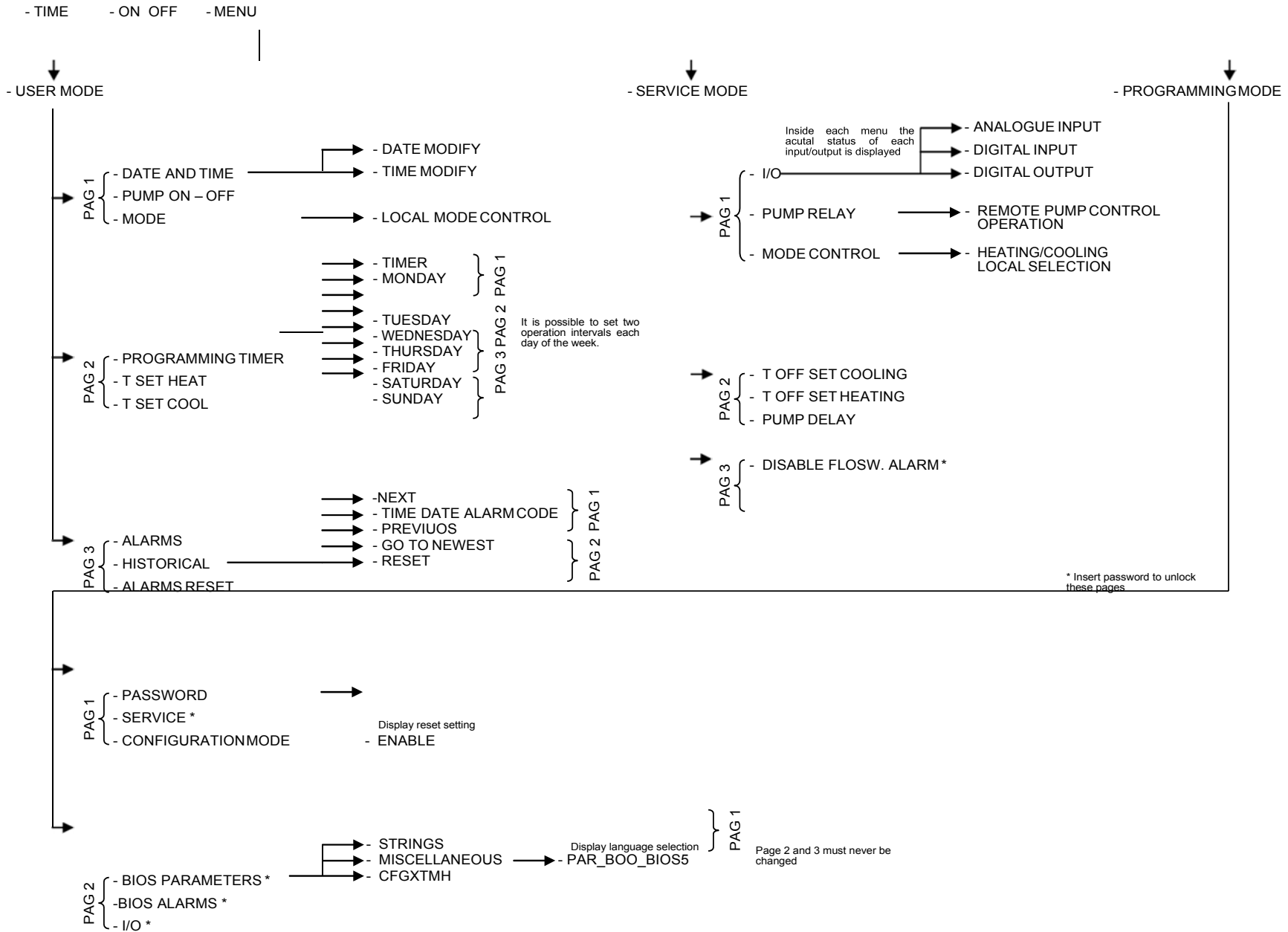

7 Switching the Yoshi AWS ducted unit on/off

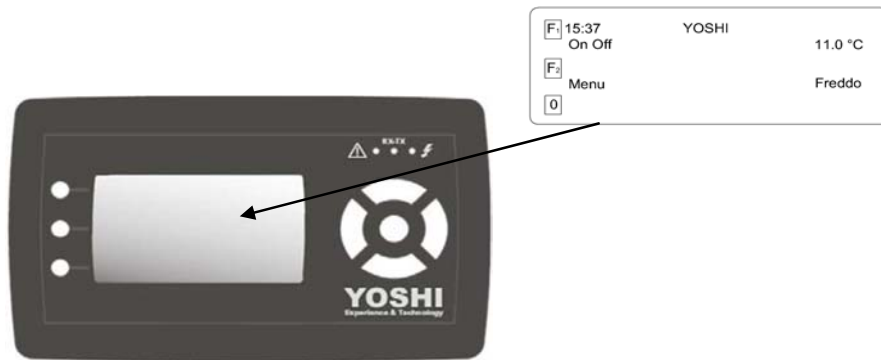

To turn on the AWS there are two ways: directly from the control panel installed on board of the module (**local procedure**), or via a switch located at a distance from the module (**remote procedure**).

The procedure will be selected by the service center at the first start of the hydronic module (see the paragraph **14.2 pump control** on page 100).

Turning on the hydronic module

The AWS YOSHI raising the food switch, select the on / off the cursor highlighting the words in bold type, press the "OK". The red indicator lights indicated in the figure below.

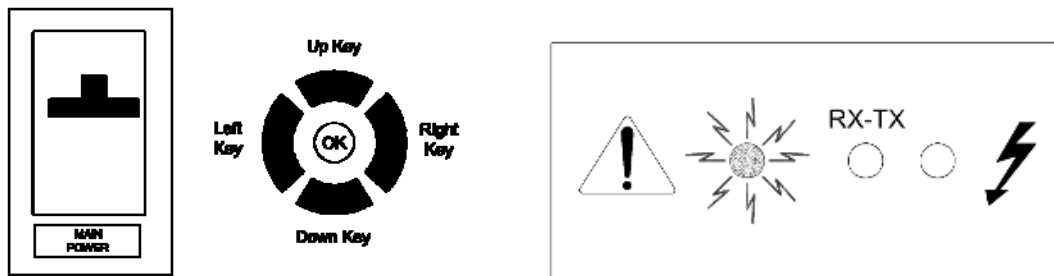

To switch off the AWS, select the on/off option again and press the "OK" key. The LED shown by the arrow will switch off.



Warning: electric shock hazard

Electrical panel voltage. Protect yourself from unwanted incoming water in the event you need to remove the protective cover.

8 Language selection

To select the language, use the following screen to select the option “**Programming mode**” using the bottom key of the selection keypad. Confirm the setting with the “OK” key.

F₁	MENU	01/01
	User mode	
F₂		
	Service mode	
0	Programming mode	

This will open the following page.

F₁	PROGRAMMING MOD	01/01
	Password	
F₂		
	Configuration mode	
0		

Select “**Password**” with the “OK” key. This will open the following screen.

F₁	PASSWORD
F₂	*****
0	

English

Select the first asterisk * with the “OK” key. When the asterisk starts to flash, press the top button of the selection keypad. The symbol + will appear in place of the asterisk.

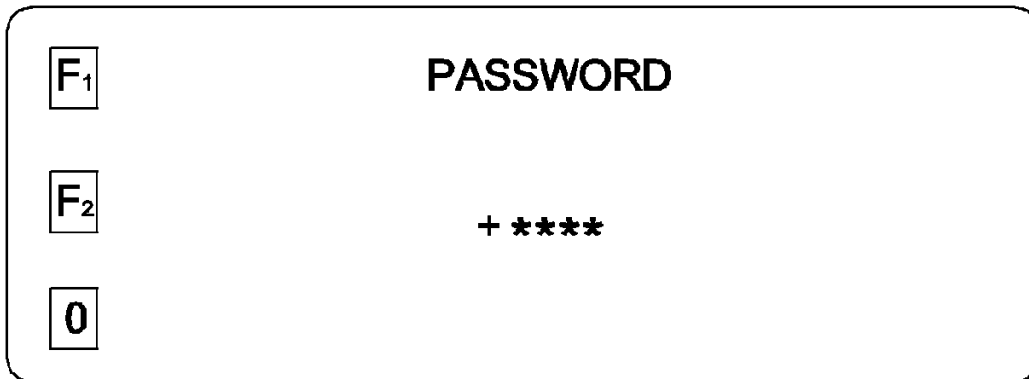

Press the “OK” key to confirm the selection. The display will show the following screen.

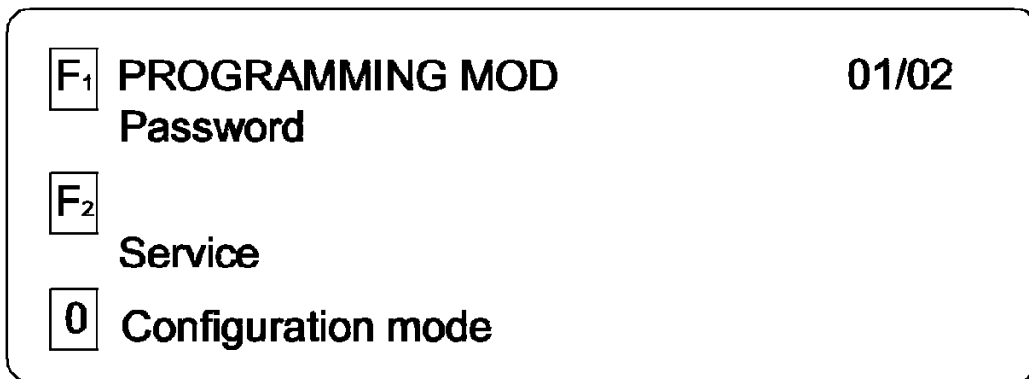

Select the next page 02/02.

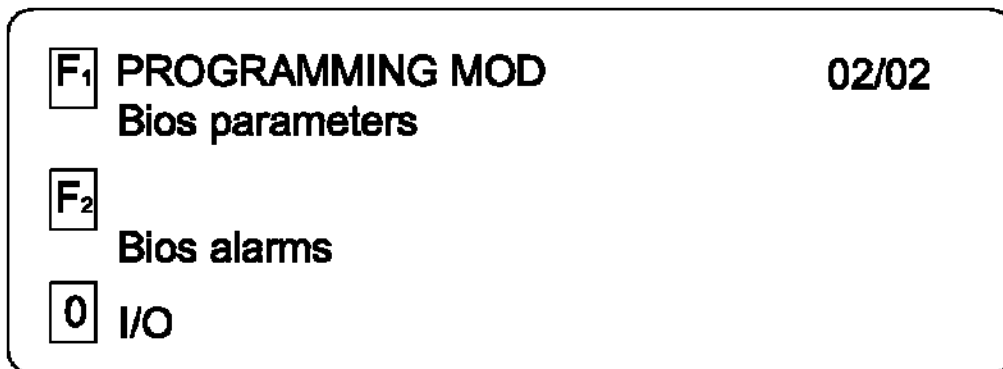

Select "Bios parameters" which will open the following screen.

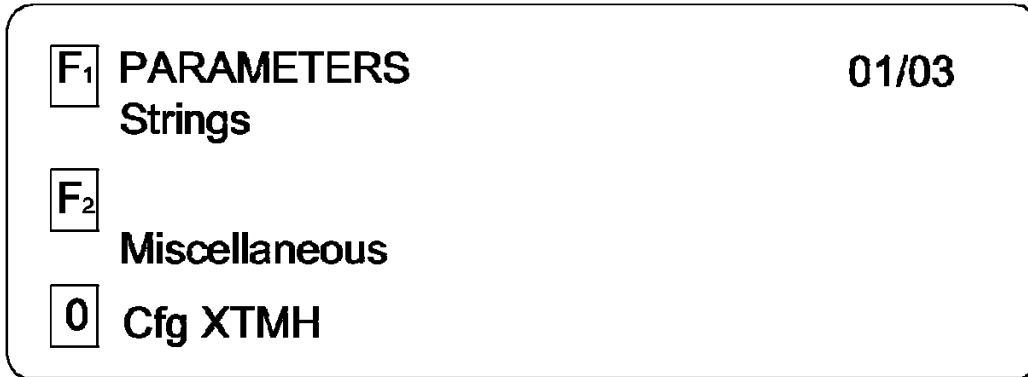

Select "Miscellaneous" to open the page.

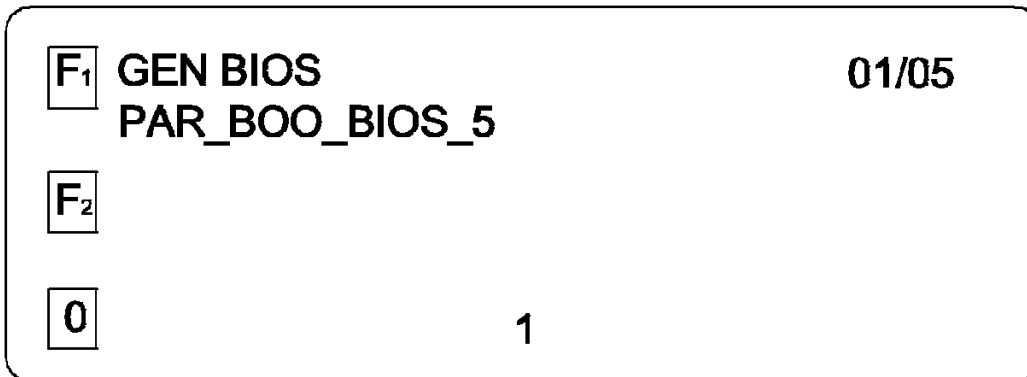

English

To select Italian as the language:

- Select the number "1" ;
- Press the bottom key on the selection keypad. The number "1" will be replaced by a zero "0" which will enable Italian as the language;
- Press the "OK" key to confirm the selection.

Note: The English language is chosen selecting the number 1.

9 Menu

The menu is opened from the following main screen which shows the time, the water's return temperature and the current operating mode (hot/cool).

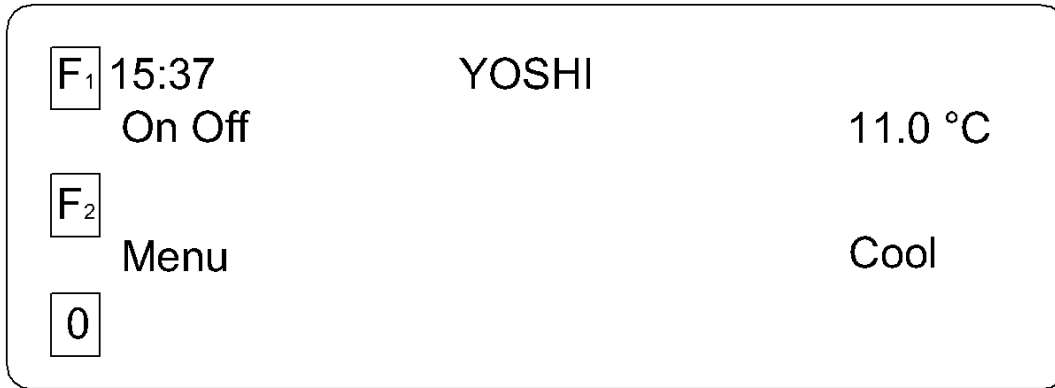

Use the button pad to select the “**Menu**” option, which will open a section comprised of the three following submenus:

- User mode
- Service mode
- Programming mode.

10 User mode

All of the adjustment and control options available to the user are described in this menu.

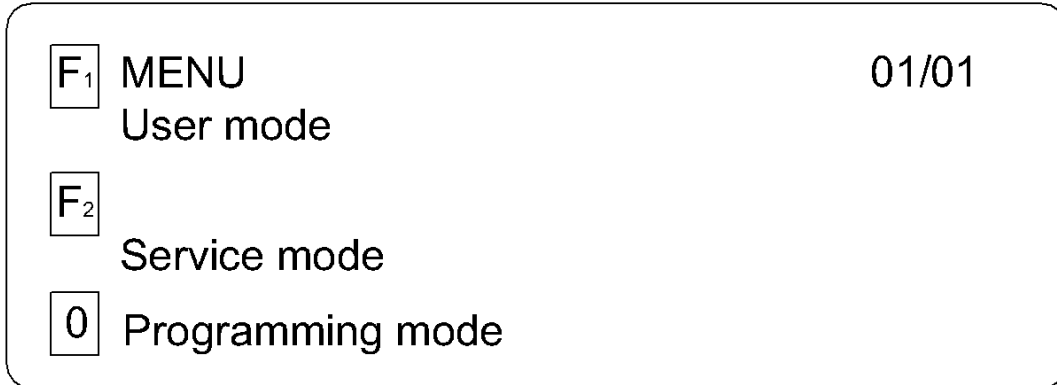

The “user mode” menu gives access to the following functions:

Screen 1/3

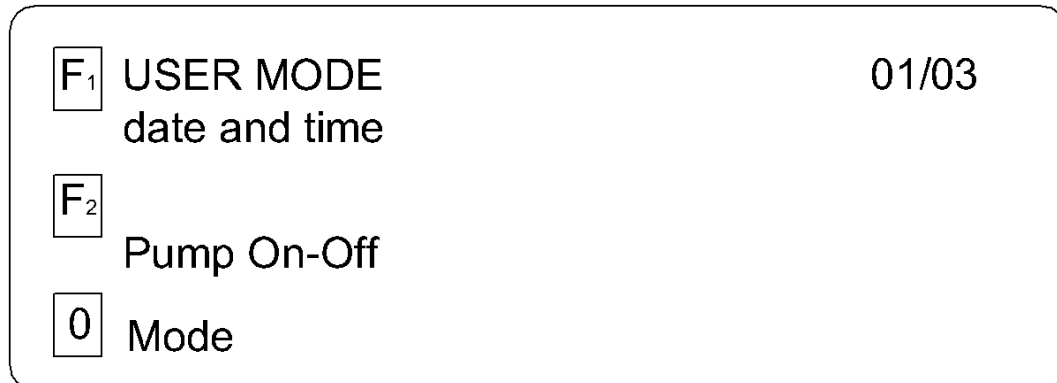

Screen 2/3

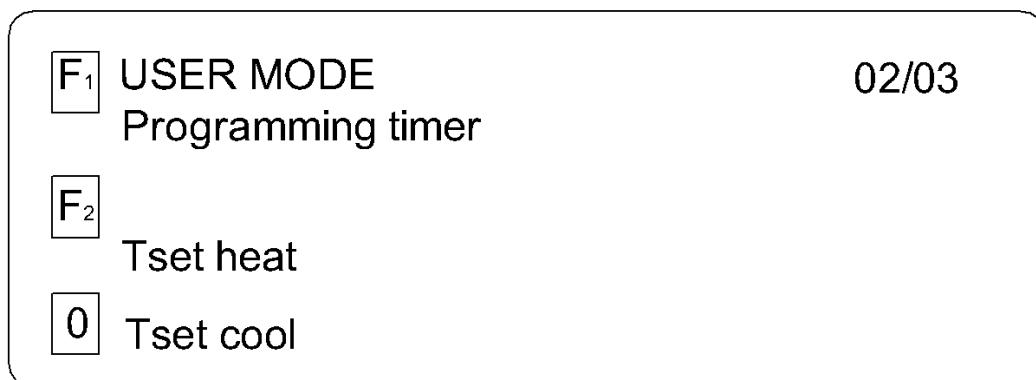

F₁	USER MODE	03/03
	Alarms	
F₂	Historical	
0	Alarms reset	

10.1 **Date and time menu**

F₁	DATE AND TIME	01/01
	29/06/10 09:33	
F₂	Date modify	
0	Time modify	

English

This function serves to set the date and time, as follows:

a)

F₁	DATE MODIFY	01/01
	GG	29
F₂	MM	June
0	AA	10

b)

F₁	TIME MODIFY	01/01
	HH	9 h
F₂		
	MM	33 Min
0		10

10.2 Heating/cooling mode settings (user mode menu)

This function serves to choose the cooling or heating mode.

There are two ways to select the operating mode:

Local mode control directly from the control panel installed on board the unit.

To select the required mode, press the “OK” key. Use the up or down key on the pad to select the operating mode. Press “OK” again to confirm the chosen option.

F₁		01/01
F₂	Local mode control	
0	Cool	

Remote mode control using a switch installed at a distance from the unit (see at page 74).

11 Programming operating times

11.1 Timer programming menu

This menu is comprised of the following three pages:

Page 1/3

F₁	SETTINGS	01/03
	Timer	Off
F₂	Monday	
0	Tuesday	

Page 2/3

F₁	SETTINGS	02/03
	Wednesday	
F₂	Thursday	
0	Friday	

Page 3/3

F₁	SETTINGS	03/03
	Saturday	
F₂	Sunday	
0		

English

11.2 Timer setting

Select the Timer function and the screen below will open

A screenshot of a control panel interface. It features three function keys: **F₁**, **F₂**, and **0**. The **F₁** key is labeled "Timer" and the **F₂** key is labeled "Off". The text "01/01" is displayed in the top right corner of the panel.

To control the on and off functions of the YOSHI AWS with the timer, use the "OK" key to select Off (timer disabled) or On (timer enabled).

Confirm the selection with the "OK" key.

11.3 Time interval setting

It is possible to set two time intervals for operation for every day of the week. Each interval will have a start and stop time for the AWS.

Time interval 1)

This interval is represented by the following screen: Period 1/2

A screenshot of a control panel interface for "Monday Timer 1/2". It features three function keys: **F₁**, **F₂**, and **0**. The **F₁** key is labeled "Monday Timer 1/2". The **F₂** key is labeled with "o", "6 h", "o", and "0 Min". The **0** key is labeled with "o", "10 h", "o", and "30 Min".

The **F₂** line represents the starting time for the AWS. The **0** line represents the stopping time for the AWS.

To set the required hour, select the **o** symbol, press “OK”, and use the up and down keys on the keypad to select the time. Press the ”OK” key to confirm the setting. The same process is used to set the minutes.

Time interval 2)

This interval is represented by the following screen: Period 2/2

F₁	Monday				
	Timer 2/2				
F₂					
<input type="radio"/>		16 h	<input type="radio"/>		0 Min
0					
<input type="radio"/>		20 h	<input type="radio"/>		30 Min

English

The **F2** line represents the starting time for the AWS. The **0** line represents the stopping time for the AWS.

To set the required hour, select the **o** symbol, press “OK”, and use the up and down keys on the keypad to select the time. Press the ”OK” key to confirm the setting.

The same process is used to set the minutes.

Repeat these steps to select the operating intervals for the remaining days of the week.

Note: It is only possible to switch the AWS on/off manually (from the control panel or remote switch) if the timer is set to “Off” or during the times outside of the set operation intervals.

12 Setting the set point temperature

The default settings for the thermostat set point are:

- COOL mode: T set cool = 11°C -- $\otimes T = 2^\circ\text{C}$
- HEAT: T set heat = 42°C -- $\otimes T = 2^\circ\text{C}$

12.1 T set heat (heating)

To set the set point temperature for heating, select the function “T set heat” from screen 02/03 of the “**user mode menu**” and the following screen will open

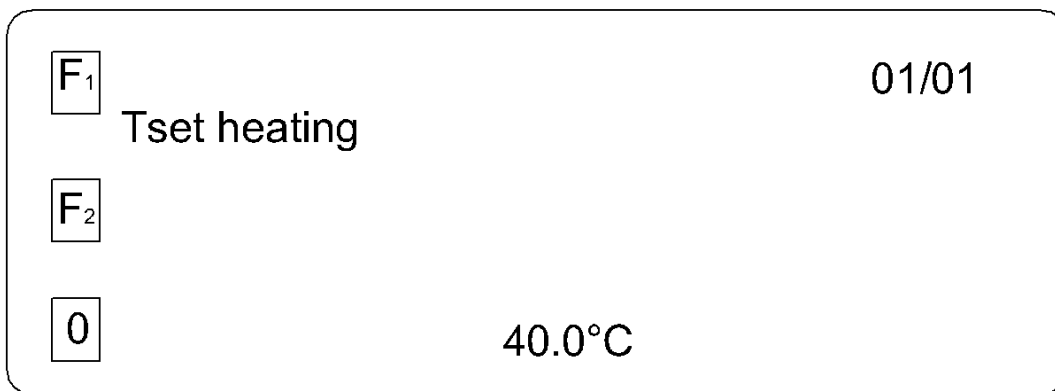

Select the highlighted temperature with the “OK key. Use the up and down keys on the keypad to increase or reduce the temperature on the screen.

Press the “OK” key to confirm the new temperature setting.

Note: The T set temperature is a mathematical average between the set point temperature and the temperature at which the AWS restarts.

Example

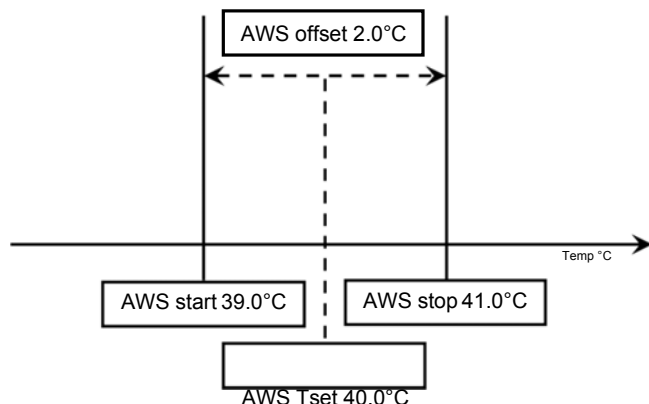
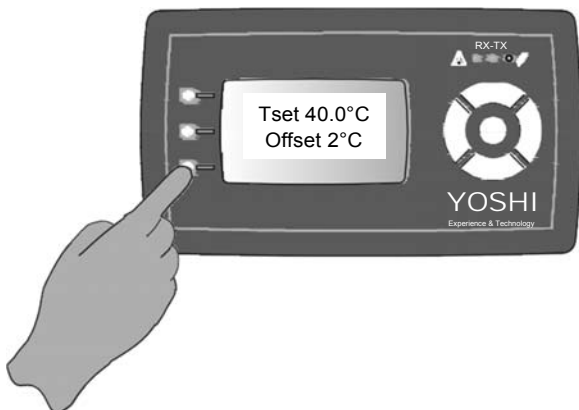

12.2 T set cool (cooling)

To set the set point temperature for cooling, select the function “T set cooling” from screen 02/03 of the “**user mode menu**” and the following screen will open

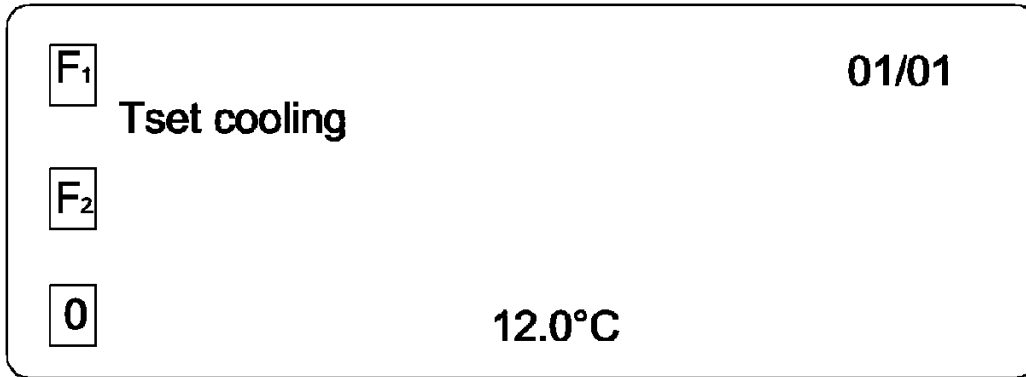

Select the highlighted temperature with the “OK key. Use the up and down keys on the keypad to increase or reduce the temperature on the screen.

Press the “OK” key to confirm the new temperature setting.

Note: The T set temperature is a mathematical average between the set point temperature and the temperature at which the AWS restarts.

13 Alarms

13.1 Alarms menu

In case of anomalies on the AISIN GHP outdoor unit or the YOSHI AWS, the LED shown by the arrow will start to flash. The type of alarm triggered by the anomaly will be shown on the control panel display.

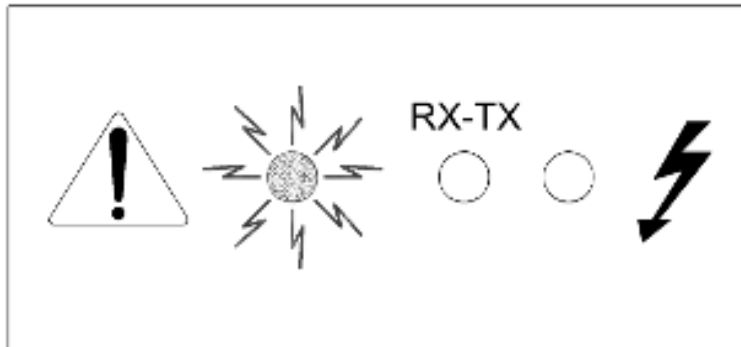

To see the list of alarms in progress, select the “Alarms” function in screen 03/03 of the USER MODE MENU and the following screen will open

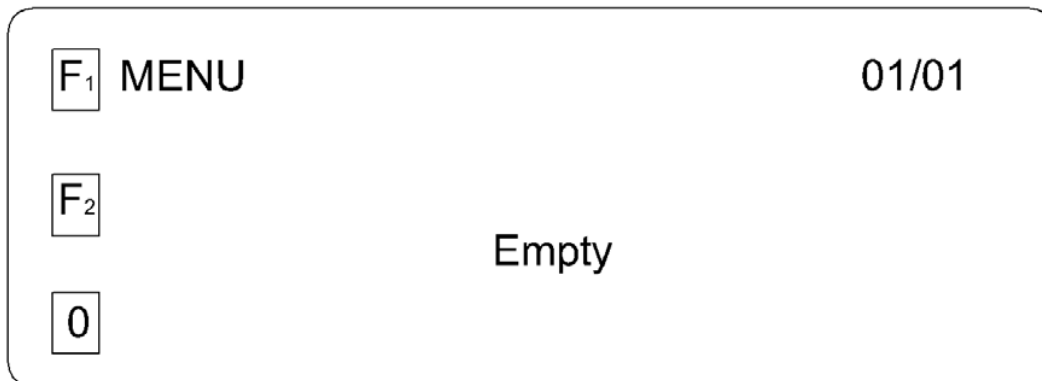

If no alarms have been recorded, then the display will read “Empty”.

Note: See page 89 for the list of possible recorded alarms for the AWS.

13.2 Alarms history menu

This menu contains the last 50 alarms. The menu is formed by two screens

Screen 1/2

This shows the time, date and alarm code for the anomaly that has occurred.

Select “next” or “previous” to view the following or previous alarm to the one shown on the screen.

<input type="button" value="F<sub>1</sub>"/>	Historical			01/02
<input type="button" value="F<sub>2</sub>"/>	Next			
	Time	Date	Alarm code	
<input type="button" value="0"/>	Previous			

English

Screen 2/2

This section serves to request that the newest recorded alarm be displayed on screen 1/2 by selecting “Go to newest”.

The Reset option serves to delete the last 50 recorded alarms.

<input type="button" value="F<sub>1</sub>"/>	Historical			02/02
<input type="button" value="F<sub>2</sub>"/>	Go to newest			
	Reset			
<input type="button" value="0"/>				

13.3 Alarms reset menu

To delete the list of alarms in progress, select the “Alarms reset” function on screen 03/03 of the USER MODE MENU and the screen shown below will appear.

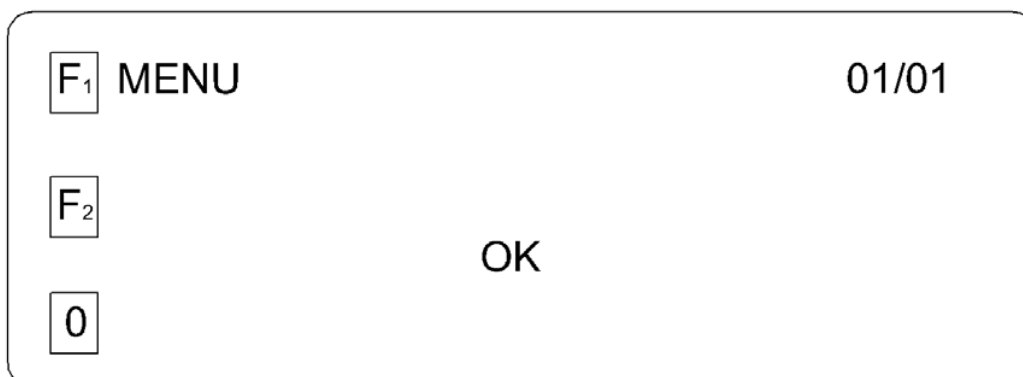

The word “OK” means that the list of alarms in progress has been deleted.

13.4 AWS alarms list

ALARM TYPE	ALARM CODE	POSSIBLE CAUSES	SOLUTIONS
Flow switch alarm	A1S1	<ul style="list-style-type: none"> • Y-filter clogged • Capacity insufficient 	<ul style="list-style-type: none"> • Clean the Y-filter • Check the pressure in the hydraulic circuit • Check the flow switch
Pressure difference switch alarm	A2S1	<ul style="list-style-type: none"> • Air in the system • Pump malfunction 	<ul style="list-style-type: none"> • Remove the air • Replace the pump • Check the pressure differential switch (compare the state with the flow switch)
GHP Alarm	A3S1		<ul style="list-style-type: none"> • Check the code displayed on the GHP. Press UP for the current alarms and DOWN for those in STAN-BY
Flow switch tamper alarm	A4S1		<ul style="list-style-type: none"> • Check the wiring of the flow switch. • Check the operation of the flow switch. • Check the layout of plant (other pumps make circulate water when not expected)
Antifreeze alarm	A5S1		<ul style="list-style-type: none"> • Check the operation of the pump, the flow switch and pressure differential switch • Verify that the offset values in summer operation are not excessive • Check the temperature probes and their wiring
Return temperature probe alarm	A6S1		<ul style="list-style-type: none"> • Check the probe and the wiring
Antifreeze temperature probe alarm	A7S1		<ul style="list-style-type: none"> • Check the probe and the wiring
Expansion valve driver alarm	A8S1		<ul style="list-style-type: none"> • Use the Carel display. Press "help" and check which component is in alarm

13.5 GHP outdoor unit alarms list

All of the anomalies that can be seen on the remote control display are listed below. In case of anomaly, contact the Aisin Authorized Technical Assistance Service responsible for maintenance on the GHP outdoor unit.

R/C AWS	Blinking indication (ON doesn't blink) (OFF led off)			GHP outdoor unit display	Type of failure	Possible cause
	Led ON/OFF	TEST Disp.	Unit No.			
A0	X	X	X	63-n	External input	<ul style="list-style-type: none"> External protection input signal stops the unit Remote controller local setting failure
A1	X	X	X	20-n	Indoor unit PC board	<ul style="list-style-type: none"> PC board defective EEPROM setting error
A3	X	X	X	95-n	Drain lines - AWS flow switch	<ul style="list-style-type: none"> Direct Expansion version – indoor unit drain pump malfunction . AWS version – flow switch or antifreeze thermostat switched off.
A6	X	X	X	15-n	Indoor unit fan motor	<ul style="list-style-type: none"> Fan motor blocked Harness disconnection
A7	ON	X	X	35-n	Indoor unit swing flap motor	<ul style="list-style-type: none"> Swing flap motor malfunction Cam mechanism failure
A9	X	X	X	21-n	Indoor unit PC board	<ul style="list-style-type: none"> LEV malfunction Harness disconnection
AF	ON	OFF	X	30-n	Drain pipe	<ul style="list-style-type: none"> Improper drain piping installation (inverse draft) Pipe clogged
AH	ON	OFF	X	31-n	Air cleaning device	<ul style="list-style-type: none"> Indoor unit circuit board malfunction Air cleaning device failure (optional)
AJ	X	X	X	22-n	Capacity setting	<ul style="list-style-type: none"> Capacity setting failure Missing capacity setting adapter (replacement of PCB)
C4	X	X	X	18-n	Indoor unit temperature sensors	<ul style="list-style-type: none"> Heat exchanger temperature sensor failure Improper harness connection
C5	X	X	X	19-n		<ul style="list-style-type: none"> Gas pipe temperature sensor failure Improper harness connection
C9	X	X	X	97-n		<ul style="list-style-type: none"> Direct Expansion version - Intake air temperature sensor failure AWS version – Resistors group failure Improper harness connection
CA	X	X	X	98-n		<ul style="list-style-type: none"> Exhaust air temperature sensor failure Improper harness connection
CJ	ON	OFF	X	17-n	R/C temperature sensor	<ul style="list-style-type: none"> R/C temperature sensor failure Improper harness connection
U3	X	X	X	-	Test run	<ul style="list-style-type: none"> Test run operation
U4	X	X	X	-	Communication	<ul style="list-style-type: none"> Outdoor unit power supply OFF Outdoor unit – indoor unit transmission error
U5	X	X	X	1-n	Communication	<ul style="list-style-type: none"> Duplicating main remote controller connection Transmission error
	OFF	ON	OFF	-	Remote controller PC board	<ul style="list-style-type: none"> Remote controller PC board failure Remote controller setting failure
U8	X	X	OFF	-	Remote controller PC board	<ul style="list-style-type: none"> Transmission error between main and sub remote controller
U9	X	X	X	-	Communication	<ul style="list-style-type: none"> Transmission error between two indoor units Transmission error between outdoor and indoor unit
UC	ON	ON	ON	36-n	Central remote controller	<ul style="list-style-type: none"> Address duplication of central remote controller Air-net address duplication of indoor units
UE	X	X	X	23-n		<ul style="list-style-type: none"> Transmission error between indoor unit and central remote controller
UF	X	X	X	24-n	Communication	<ul style="list-style-type: none"> Communication error between indoor and outdoor unit Improper wiring
UH	X	X	X	-		<ul style="list-style-type: none"> Indoor unit address setting failure
E1	X	X	X	40-0~2	Outdoor unit PC board	<ul style="list-style-type: none"> EEPROM failure or program failure
	X	X	X	84-3,4		<ul style="list-style-type: none"> Outdoor unit PC board malfunction Transmission error between microcomputer
E3	X	X	X	86-0	Operation failure	<ul style="list-style-type: none"> Refrigerant High pressure alarm
E4	X	X	X	88-0		<ul style="list-style-type: none"> Refrigerant Low pressure alarm
E7	X	OFF	X	86-10~23	Outdoor unit fan	<ul style="list-style-type: none"> Heat exchanger fan (1,2,3) failure DCBL board failure

EA	X	X	X	57-0	4-way valve	<ul style="list-style-type: none"> 4-way valve failure Harness disconnection 	
EC	X	X	X	80-0	Operation failure	<ul style="list-style-type: none"> Engine coolant overheating (temperature >105°C) 	
EH	X	X	X	80-10~30	Engine coolant pump	<ul style="list-style-type: none"> Engine coolant pump failure DCBL board failure 	
F3	X	X	X	91-0	Operation failure	<ul style="list-style-type: none"> Compressor discharge temperature too high (>120°C) 	
F4	X	X	X	87-0,2		<ul style="list-style-type: none"> Compressor intake temperature too high (> 40°C) 	
FE	X	X	X	81-0	Engine oil	<ul style="list-style-type: none"> Abnormal engine oil pressure Engine oil level insufficient 	
FF	X	X	X	58-0	Compressor oil	<ul style="list-style-type: none"> Refrigerant oil supply valve failure Improper harness connection 	
FJ	X	X	X	47-0	Catalyser	<ul style="list-style-type: none"> Catalyser overheating (where provided) 	
H3	X	X	X	76-0	High pressure switch	<ul style="list-style-type: none"> High pressure switch malfunction Improper harness connection 	
H4	X	X	X	88-2	Low pressure switch	<ul style="list-style-type: none"> Low pressure switch malfunction Improper harness connection 	
H9	X	X	X	61-0	Outdoor unit temperature sensors	<ul style="list-style-type: none"> Outdoor temperature sensor malfunction Improper harness connection 	
H9	X	X	X	61-1		<ul style="list-style-type: none"> Outdoor temperature sensor short circuit 	
HC	X	X	X	70-0		<ul style="list-style-type: none"> Engine coolant temperature sensor malfunction Improper harness connection 	
HC	X	X	X	80-1		<ul style="list-style-type: none"> Engine coolant temperature sensor short circuit 	
HJ	X	X	X	80-2	Engine coolant	<ul style="list-style-type: none"> Engine coolant level insufficient 	
HF	X	OFF	X	EE-0	Maintenance	<ul style="list-style-type: none"> Periodic maintenance alert 	
J3	X	X	X	78-1~5	Outdoor unit temperature sensors	<ul style="list-style-type: none"> Compressor discharge temp sensor disconnected 	
	X	X	X	91-2~7		<ul style="list-style-type: none"> Compressor discharge temp sensor short circuit 	
J4	X	X	X	54-0		<ul style="list-style-type: none"> Super cooling heat ex. temp. sensor disconnected 	
	X	X	X	54-1		<ul style="list-style-type: none"> Super cooling heat ex. temp. sensor short circuit 	
	X	X	X	55-0,1		<ul style="list-style-type: none"> Accumulator outlet temp. sensor disconnected 	
J5	X	X	X	55-2,3		<ul style="list-style-type: none"> Accumulator outlet temp. sensor short circuit 	
	X	X	X	53-0,1		<ul style="list-style-type: none"> Compressor intake temp. sensor disconnected 	
J6	X	X	X	53-2,3		<ul style="list-style-type: none"> Compressor intake temp. sensor short circuit 	
	X	X	X	65-0		<ul style="list-style-type: none"> Heat exchanger liquid pipe temp. sensor disconnected Improper harness connection 	
J7	X	X	X	65-2		<ul style="list-style-type: none"> Heat exchanger liquid pipe temp. sensor short circuit 	
	X	X	X	66-0		<ul style="list-style-type: none"> Sub heat exchanger liquid pipe temp. sensor disconnected 	
J8	X	X	X	66-1		<ul style="list-style-type: none"> Sub heat exchanger liquid pipe temp. sensor short circuit 	
	X	X	X	67-0		Outdoor unit temperature sensors	<ul style="list-style-type: none"> Outdoor liquid pipe temp. sensor disconnected
JA	X	X	X	67-2		Outdoor unit pressure sensors	<ul style="list-style-type: none"> Outdoor liquid pipe temp. sensor short circuit
	X	X	X	73-0,1		Outdoor unit pressure sensors	<ul style="list-style-type: none"> High pressure sensor malfunction
JC	X	X	X	88-4		Outdoor unit pressure sensors	<ul style="list-style-type: none"> Low pressure sensor malfunction
JE	X	X	X	71-0	Oil pressure sw.	<ul style="list-style-type: none"> Oil pressure switch disconnected 	
JJ	X	X	X	72-0	Outdoor unit temperature sensors	<ul style="list-style-type: none"> Engine room temp. sensor disconnected 	
	X	X	X	72-1	Outdoor unit temperature sensors	<ul style="list-style-type: none"> Engine room temp. sensor short circuit 	
	X	X	X	72-6	Outdoor unit temperature sensors	<ul style="list-style-type: none"> Catalyser temp. sensor disconnected 	
LE	X	X	X	75-1~3	Igniter voltage	<ul style="list-style-type: none"> Igniter voltage too low or too high 	
LF	X	X	X	84-0	Operation failure	<ul style="list-style-type: none"> Engine start failure – missing supply gas 	
LJ	X	X	X	75-0		<ul style="list-style-type: none"> Unwanted engine stop 	
P8	X	X	X	74-1~4 74-6 82-0~1	Engine	<ul style="list-style-type: none"> Insufficient starting engine speed (starter failure) Abnormal engine speed (gas mixer failure) 	
PE	X	X	X	74-7	Gas valves	<ul style="list-style-type: none"> Supply electro magnetic gas valves failure 	
PF	X	X	X	60-0	Starter	<ul style="list-style-type: none"> Starter failure 	
U0	X	X	X	88-5	Ref. Piping	<ul style="list-style-type: none"> Refrigerant gas empty 	
					Communication	<ul style="list-style-type: none"> master / slave outdoor unit communication failure 	
U7	X	X	X	4-0~6	Indoor unit number	<ul style="list-style-type: none"> Over connection of capacity units Too many indoor units connected 	
UA	X	X	X	43-0,1 44-n	Operation failure	<ul style="list-style-type: none"> Compressor discharge temperature too high (>120°C) 	

14 Service mode menu

This menu is comprised of six submenus:

I/O (AWS input and output signals)

Pump relay

Mode control

T offset cooling

T offset heating

Pump delay.

The menus are shown on the two following pages

1)

F₁	SERVICE MODE	01/02
	I/O	
F₂	Pump relay	
0	Mode control	

2)

F₁	SERVICE MODE	02/02
	T off set cooling	
F₂	T off set heating	
0	Pump delay	

English

14.1 I/O menu (AWS input and output signals)

This menu is shown on the following screen

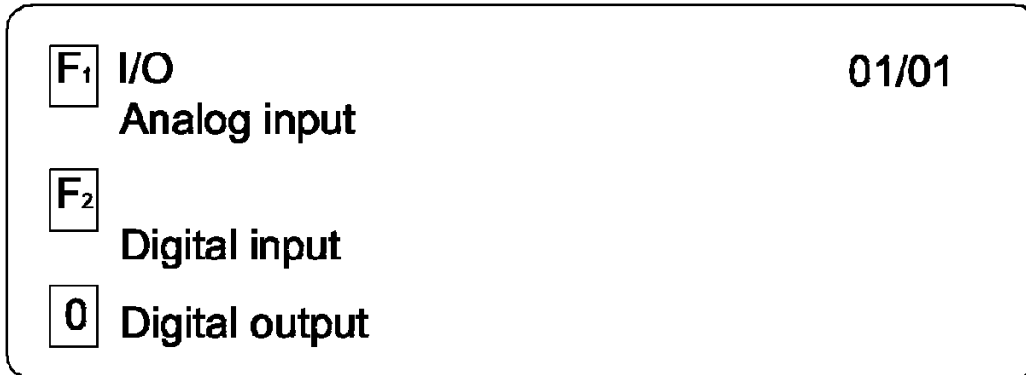

14.1.1 Analog input menu

The instructions for this submenu are shown on three screens

1) The display shows the return water temperature.

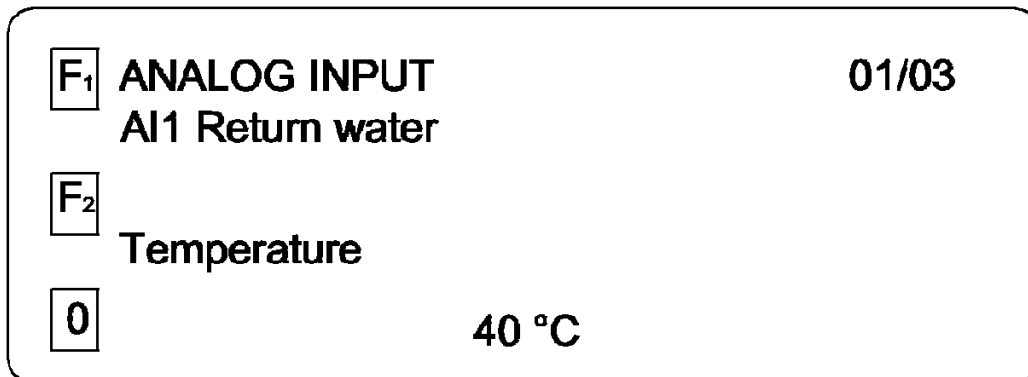

2) The temperature listed on the display as “antifreeze” shows the water delivery temperature.

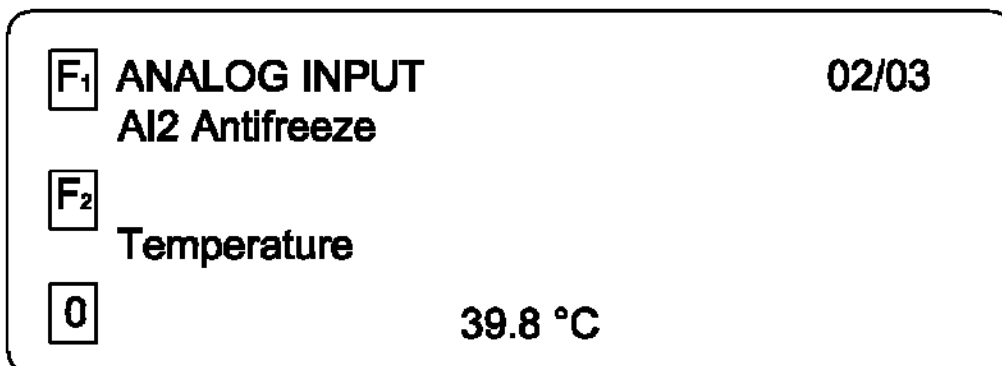

3) Dynamic setpoint

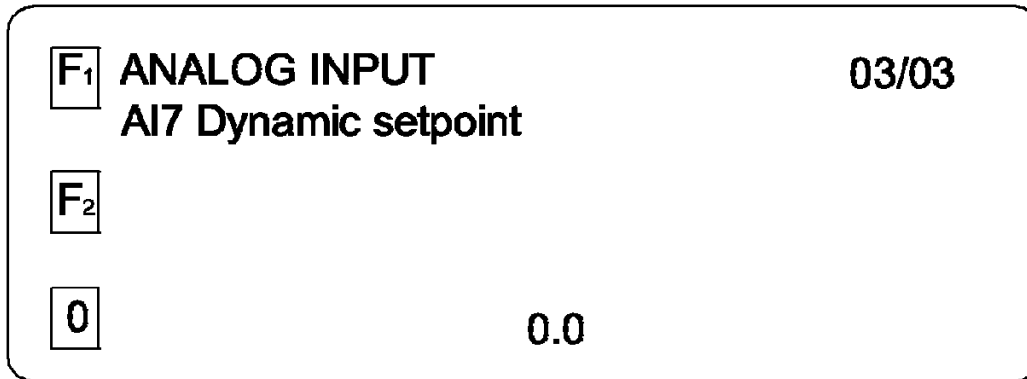

It is possible to set a variable setpoint temperature according to a voltage between 5 and 10 Volts, sent to the terminals of the AWS marked “SET-” and “SET+”.

The “dynamic setpoint” screen shows the current voltage level. If this is less than 5, then the manually set setpoint is enabled. If the voltage level shown is more than or equal to 5, then the dynamic set point is enabled.

The relationship between incoming voltage and T, the dynamic set point is the following:

Cooling

$$T_{\text{set point}} = (X - 5) * 1.8 + 11$$

Heating

$$T_{\text{set point}} = (X - 5) * 1.6 + 35$$

The variable x has values from 5 to 10 Volts.

14.1.2 Digital input menu

The instructions for this submenu are shown in eight screens.

1) The indication (Off-On) shows whether the start/stop contact from the remote switch is open (Off) or closed (On).

F₁	DIGITAL INPUT	01/08
	DI1 On-Off Remote pump	
F₂	Control	
0	Off	

2) The indication (On-Off) shows whether the heating method selected from the remote switch is enabled (On) or not enabled (Off).

F₁	DIGITAL INPUT	02/08
	DI2 Remote heating	
F₂	Selection	
0	Off	

3) The indication (On-Off) shows whether the expansion valve is operating correctly (On) or not (Off).

F₁	DIGITAL INPUT	03/08
	DI3 ok expansion	
F₂	Valve	
0	On	

4) The indication (On-Off) shows whether the flow switch is detecting water circulation (On) or not (Off).

F₁	DIGITAL INPUT	04/08
	DI5 Flow switch	
F₂		
0	Off	

5) The indication (On-Off) shows whether the differential pressure switch is detecting water circulation (On) or not (Off).

F₁	DIGITAL INPUT	05/08
	DI6 Pressure	
F₂		
	Difference switch	
0	Off	

6) The indication (On-Off) shows whether the GHP outdoor unit is operating correctly (On) or if there are malfunction alarms (Off).

F₁	DIGITAL INPUT	06/08
	DI9 GHP alarm	
F₂		
0	Off	

7) The indication (On-Off) shows whether the GHP outdoor unit is on (On) or off (Off).

F₁	DIGITAL INPUT DI11 GHP CP ON	07/08
F₂		
0	Off	

8) The indication (On-Off) shows whether the GHP outside unit is defrosting (On) or not (Off).

F₁	DIGITAL INPUT DI12 Defrost	08/08
F₂	Control	
0	Off	

14.1.3 Digital outputs menu

The instructions for this submenu are shown on seven screens.

1) The indication (On-Off) shows whether the resistance simulating the air recovery temperature is set to heating (On) or cooling (Off).

F₁	DIGITAL OUTPUT	01/07
	DO2 Ohm resistance	
F₂		
0	On	

2) The indication (On-Off) shows whether the GHP outdoor unit is operating in heating (On) or cooling mode (On).

F₁	DIGITAL OUTPUT	02/07
	DO3 GHP heating	
F₂	Selection	
0	On	

3) The indication (On-Off) shows whether the pump is operating (On) or not (Off).

F₁	DIGITAL OUTPUT	03/07
	DO4 Pump relay	
F₂		
0	Off	

4) The indication (On-Off) shows whether the GHP outdoor unit control card is receiving power (On) or not (Off).

F₁	DIGITAL OUTPUT	04/07
	DO5 Aisin PC Board	
F₂	Power supply	
0	On	

English

5) The indication (On-Off) shows whether the contact T1-T2 is closed (On GHP powered) or open (Off GHP not powered).

F₁	DIGITAL OUTPUT	05/07
	DO7 T1-T2 PC Board	
F₂		
0	Off	

6) The indication (On-Off) shows whether there are alarms (On contact closed) or not (Off contact open).

F₁	DIGITAL OUTPUT	06/07
	DO10 Alarm	
F₂		
0	Off	

7) The indication (On-Off) shows whether the valve is operating (On contact closed) or not (Off contact open).

F₁	DIGITAL OUTPUT	07/07
	DO12 Expansion valve	
F₂		
	Driver	
0		Off

14.2 Pump control

This menu serves to select the position from which to switch on the AWS. From the remote switch (**local procedure**), (select On) or directly from the control panel of the AWS (**remote procedure**), (select Off).

F₁		01/01
	Remote pump	
F₂		
	Control operation	
0		On

14.3 Mode selection

This menu serves to select the position from which to select the cool/heat operating mode. Directly from the control panel of the AWS (select On). From the remote switch (select Off).

F₁		01/01
	Heating/cooling	
F₂		
	Local selection	
0		On

14.4 Toffset cooling

This menu serves to select the number of degrees by which the cooling water temperature needs to rise before the GHP outside unit starts up again

F₁		01/01
	Toffset setpoint	
F₂		
	Cooling	
0		2.0 °C

14.5 Toffset heating

This menu serves to select the number of degrees by which the heating water temperature needs to fall before the GHP outside unit starts up again

F₁		01/01
	Toffset setpoint	
F₂	Heating	
0		2.0 °C

14.6 Pump delay

This menu serves to select the amount of time the AWS pump needs to stay on before switching off once the GHP outside unit has stopped.

F₁		01/01
	Pump delay	
F₂		
0		180 Sec.

15 Disabling the flow switch alarm

It is possible to disable the flow switch alarm as follows:

Select the programming mode menu

F₁	MENU	01/01
	User mode	
F₂	Service mode	
0	Programming mode	

Select "Password"

F₁	PROGRAMMING MOD	01/01
	Password	
F₂	Configuration mode	
0		

The following page will open.

F₁	PASSWORD
F₂	*****
0	

Use the “OK” key to select the first asterisk *. When the asterisk begins to flash, press the top key on the selection keypad. The + sign will appear in place of the asterisk.

F₁	PASSWORD
F₂	+ *****
0	

Press the “OK” key again to confirm the selection and return to the “MENU” page.

F₁	MENU	01/01
	User mode	
F₂	Service mode	
0	Programming mode	

Select “Service mode”.

Note: It is not possible to de-activate the flow switch alarm directly from the service menu without first selecting the password in the programming menu.

Select the page 03/03

F₁	SERVICE MODE	03/03
	Disable flows. alarm	
F₂		
0		

Select “**Disable flows. alarm**” to open the following page,

F₁		01/01
	Flow switch tampering	
F₂		
	Alarm disable	
0		Off

“Off” means that the flow switch alarm has been engaged. To switch it off, select “Off”. When the message starts to flash, press the top button on the select keypad to engage “On” and disable the alarm. Press “OK” to confirm the choice.

16 Wiring diagrams

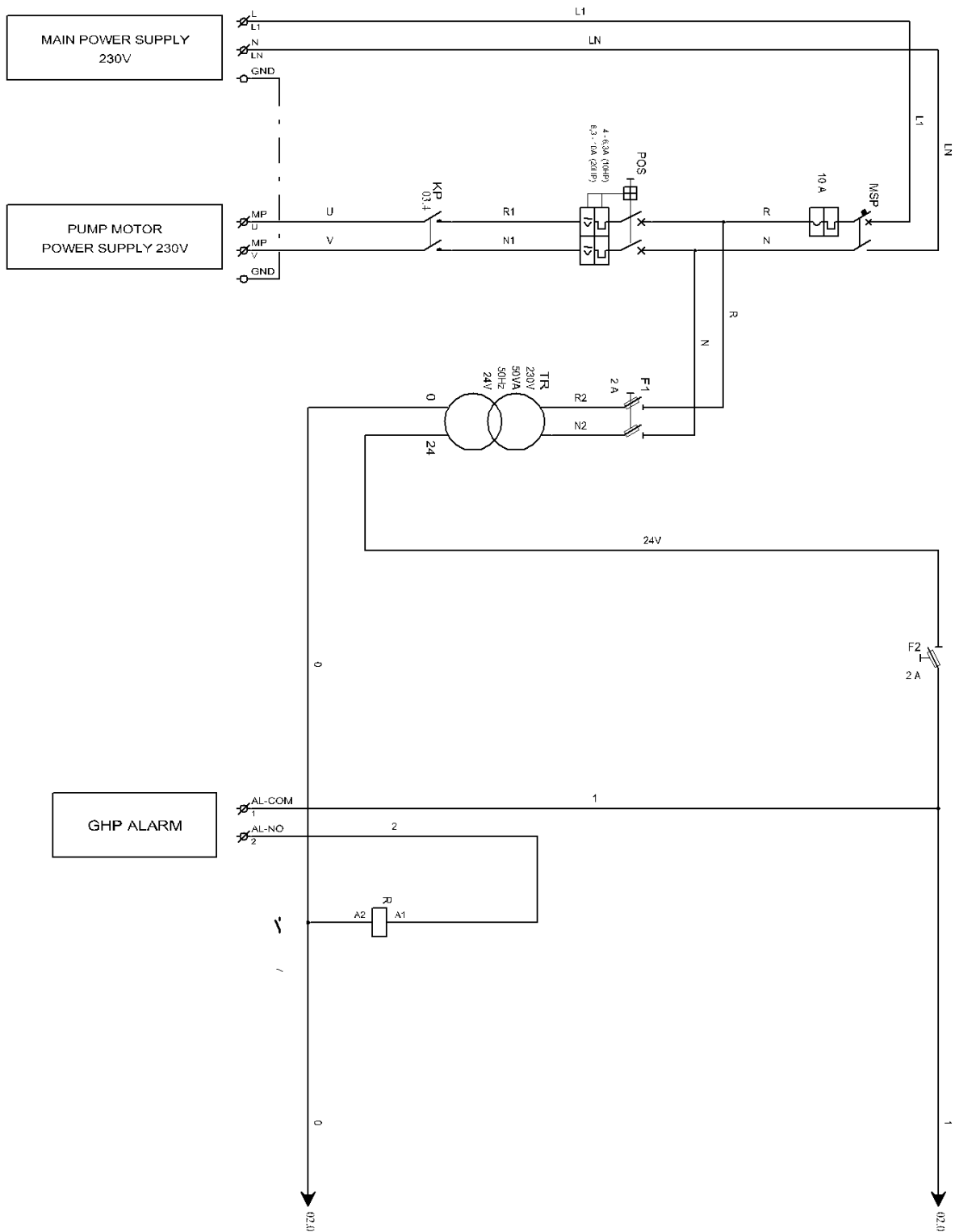

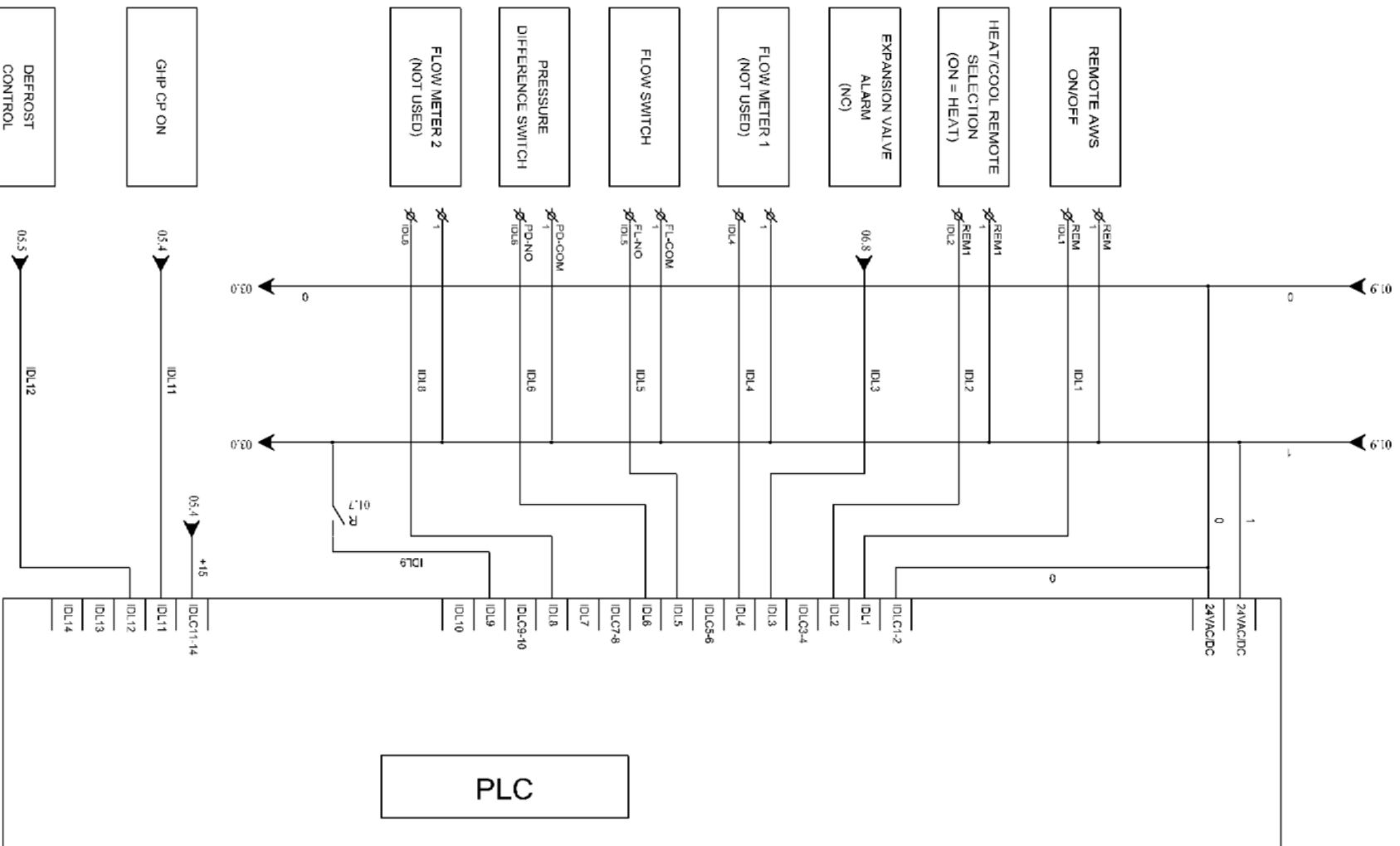

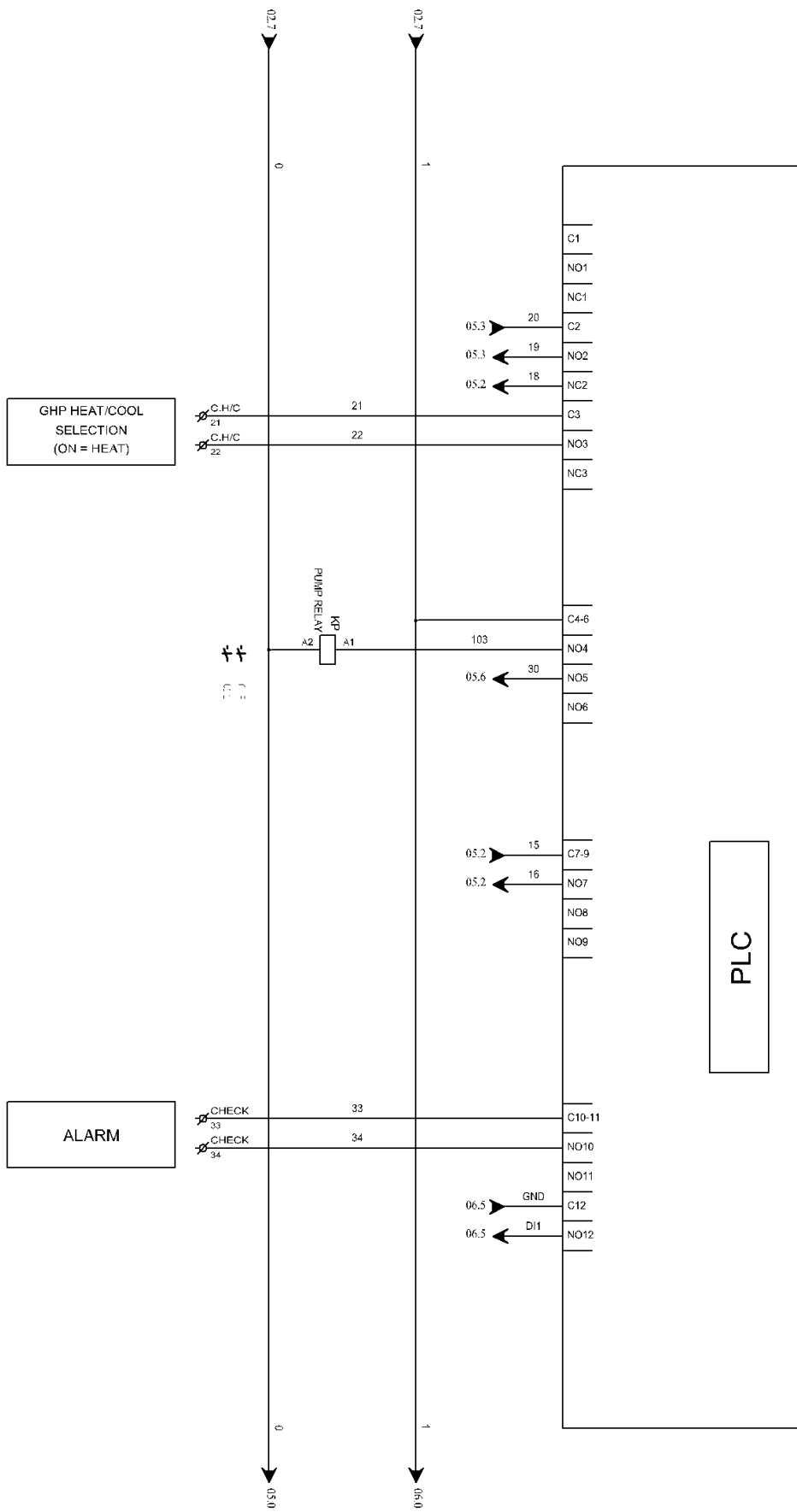

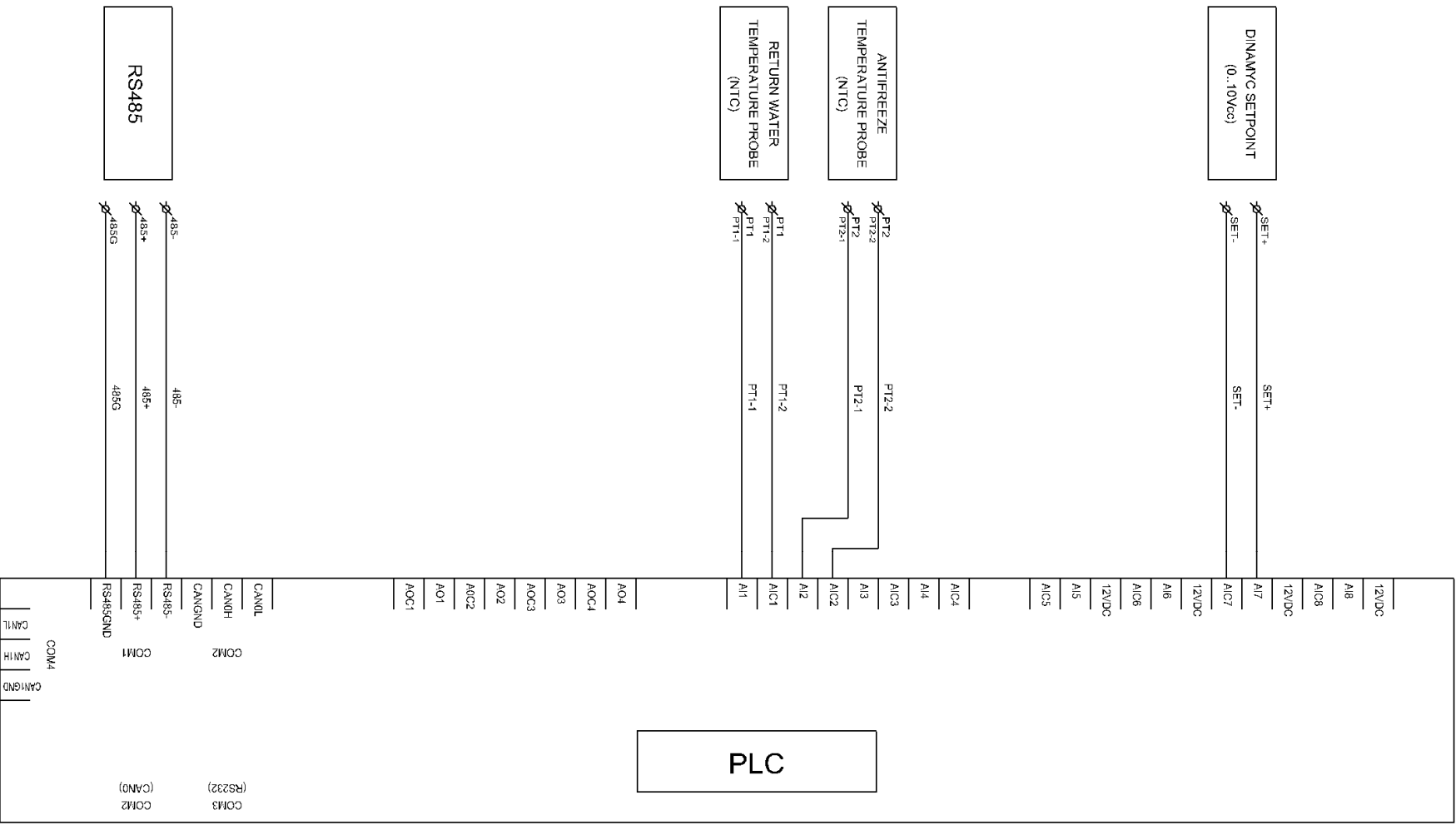

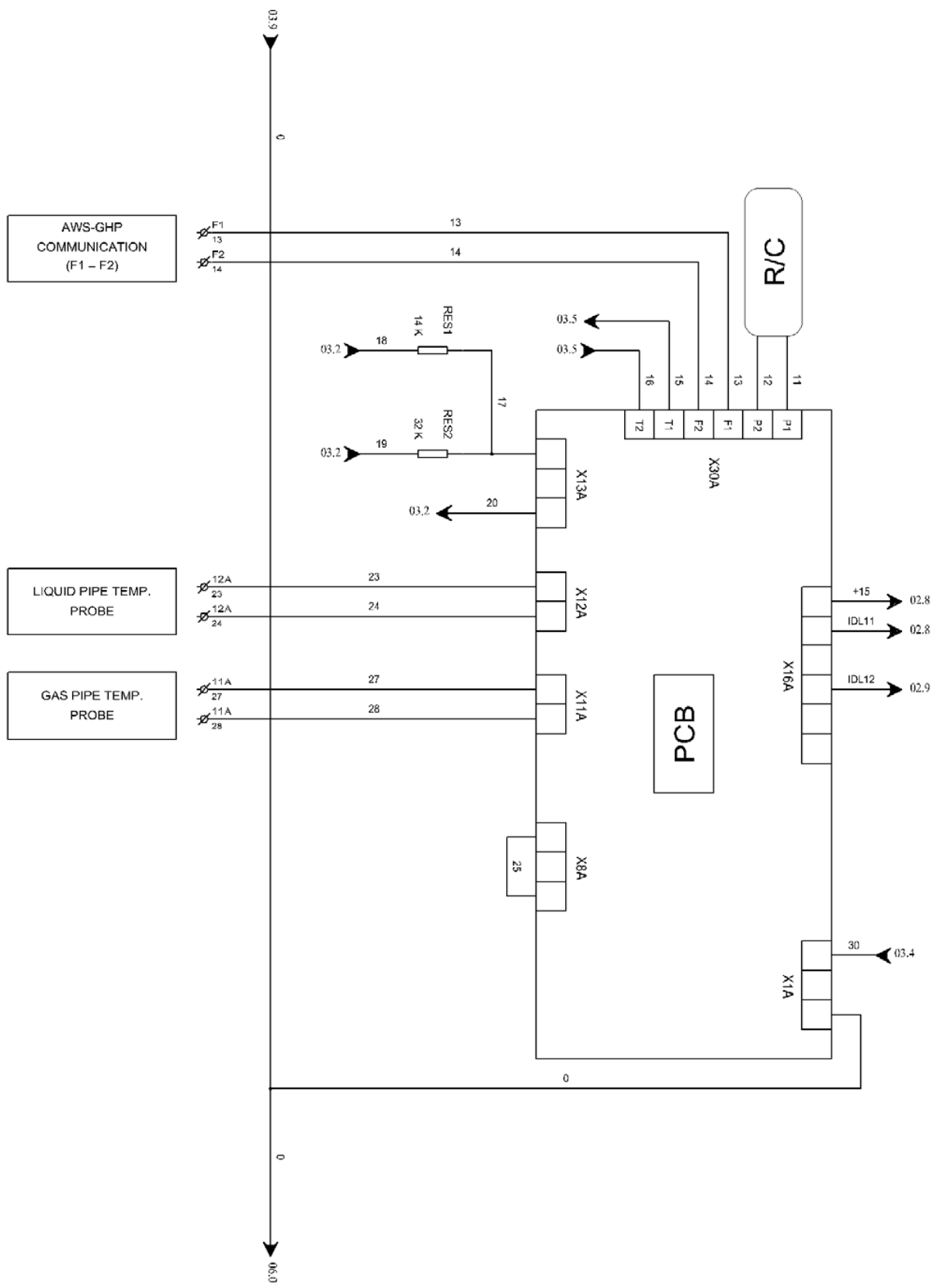

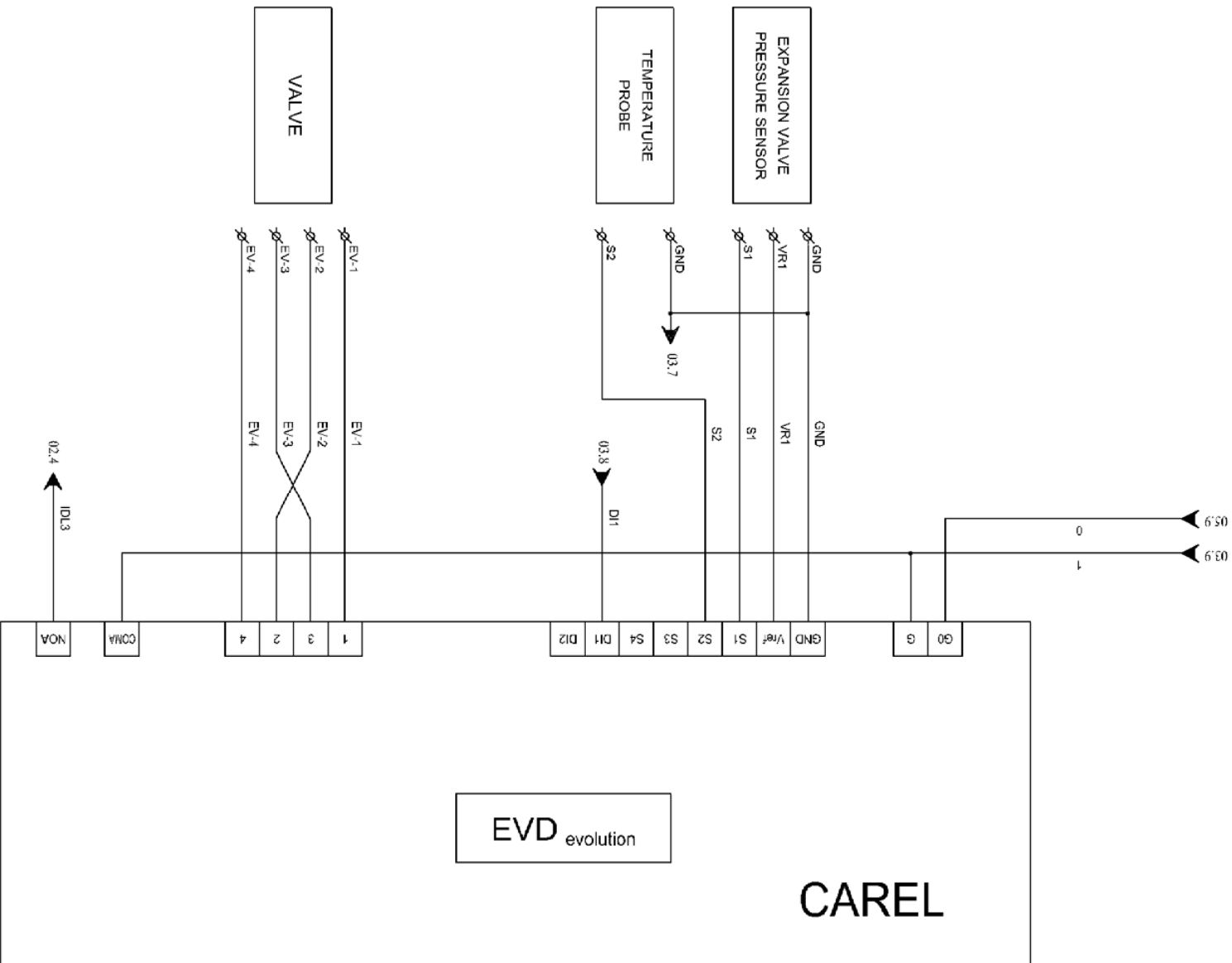

English

17 Relation between engine RPM and outside temperature

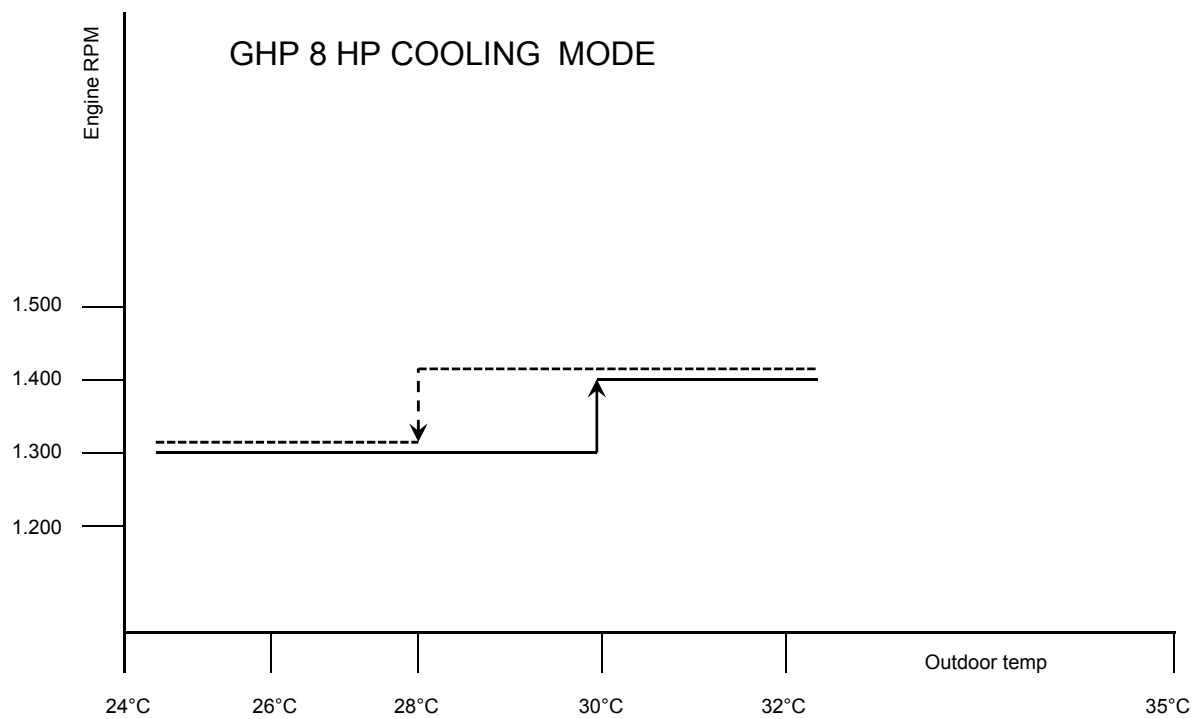
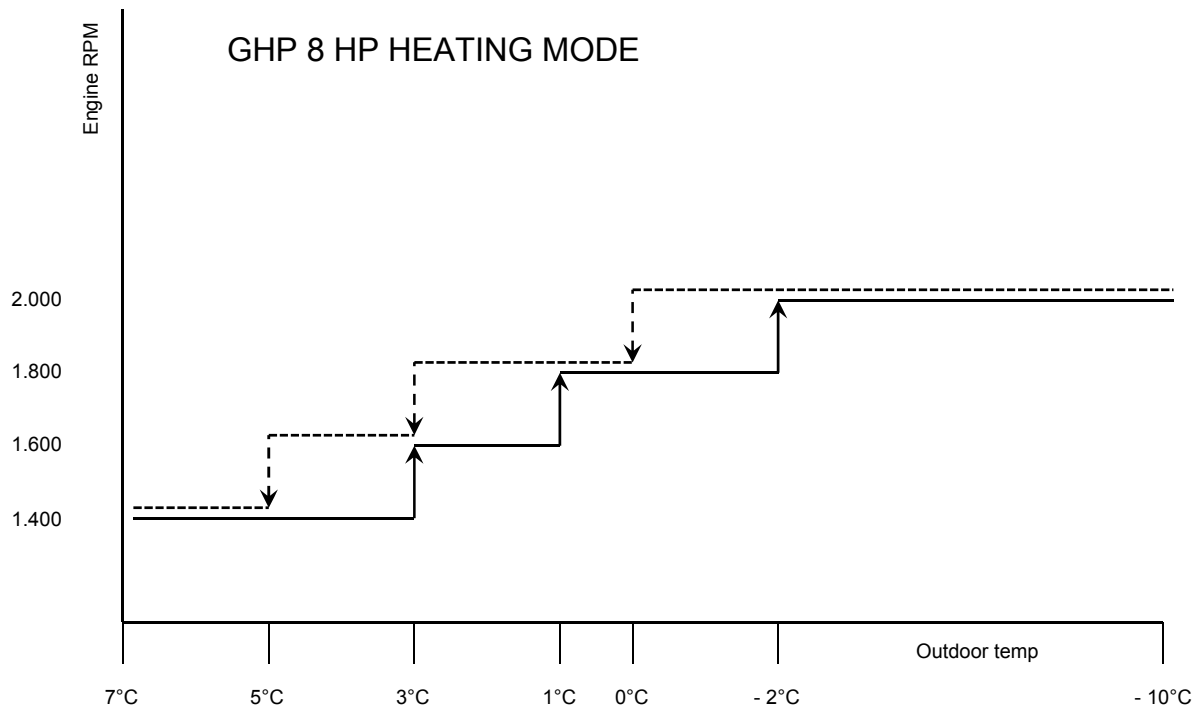

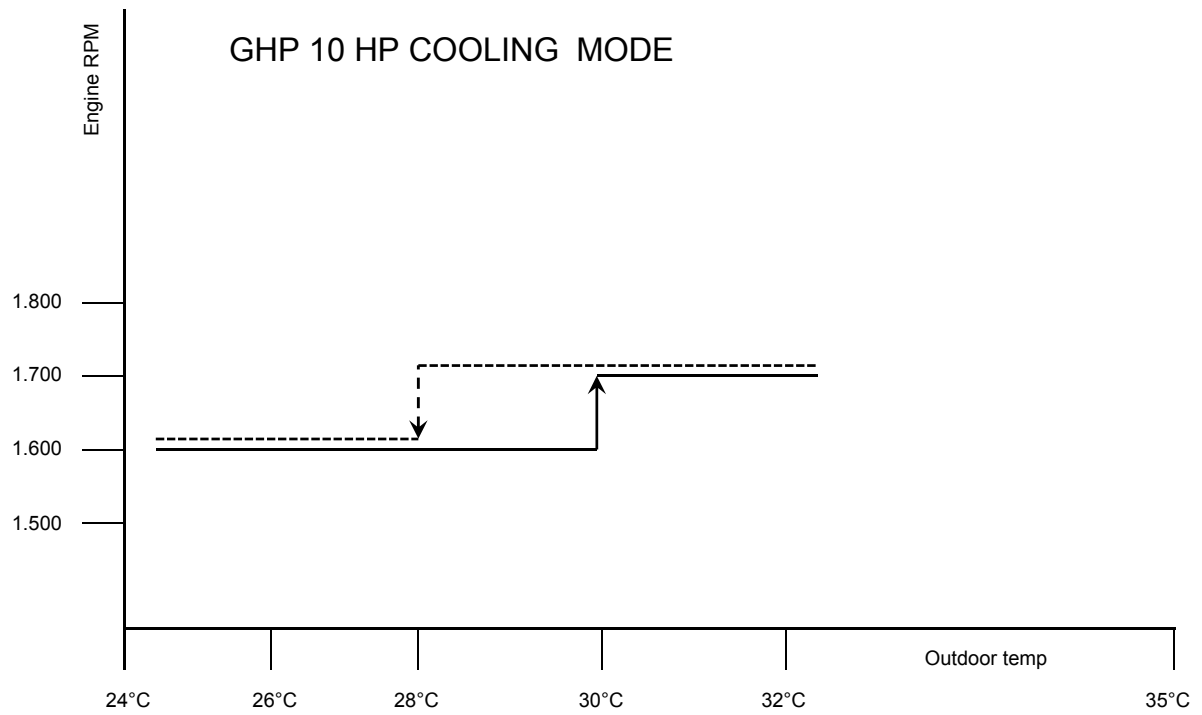
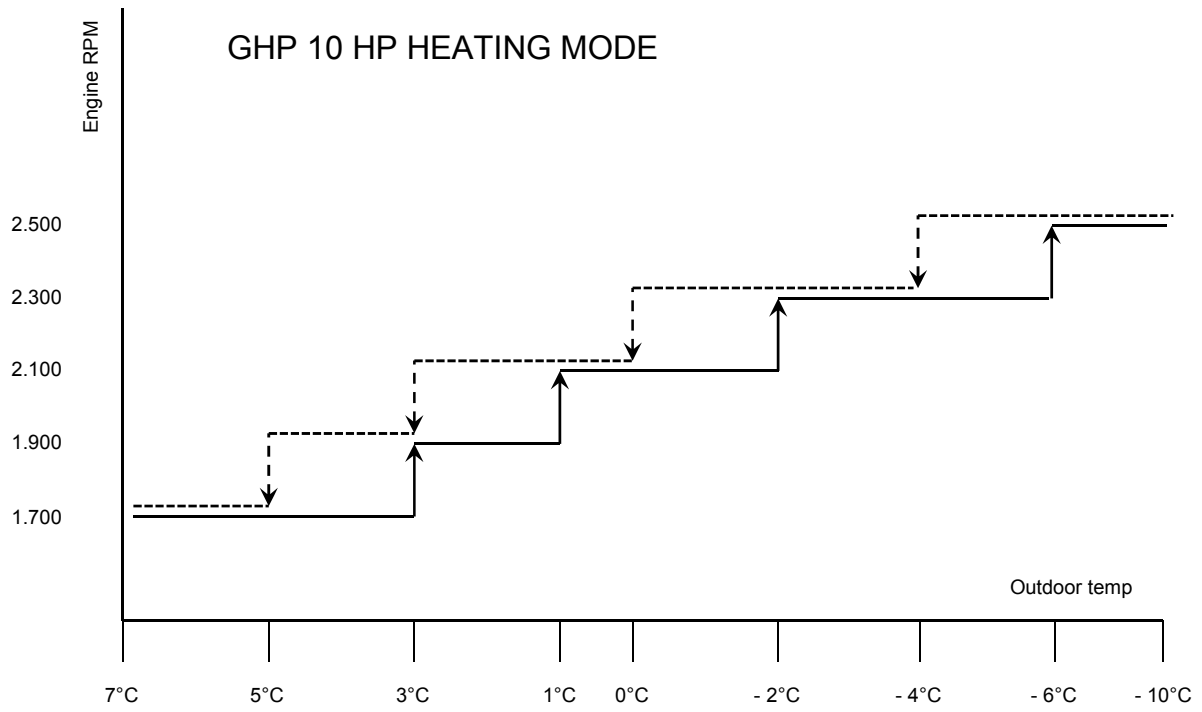

English

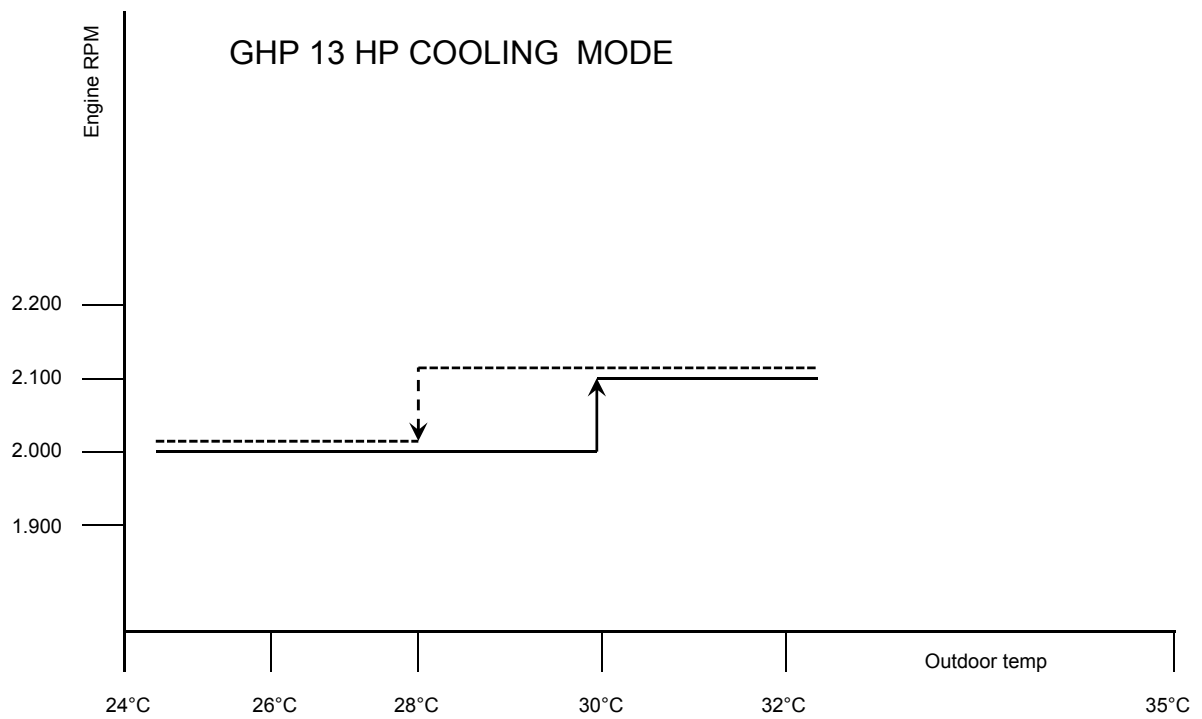
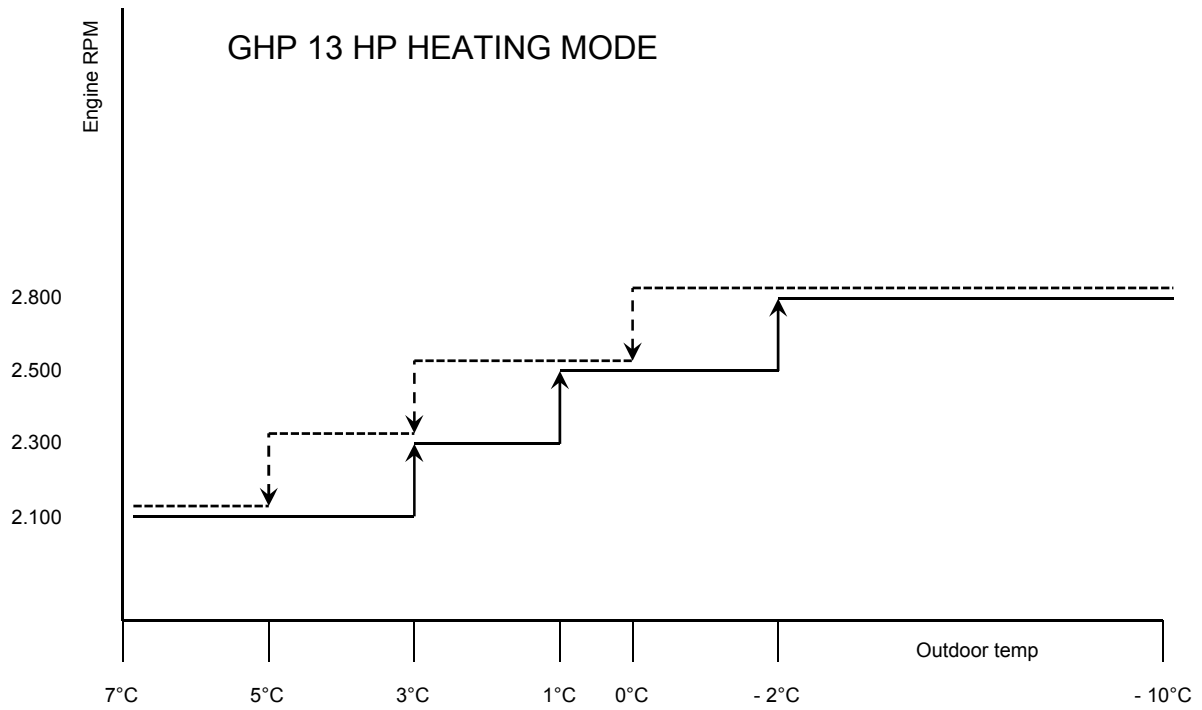

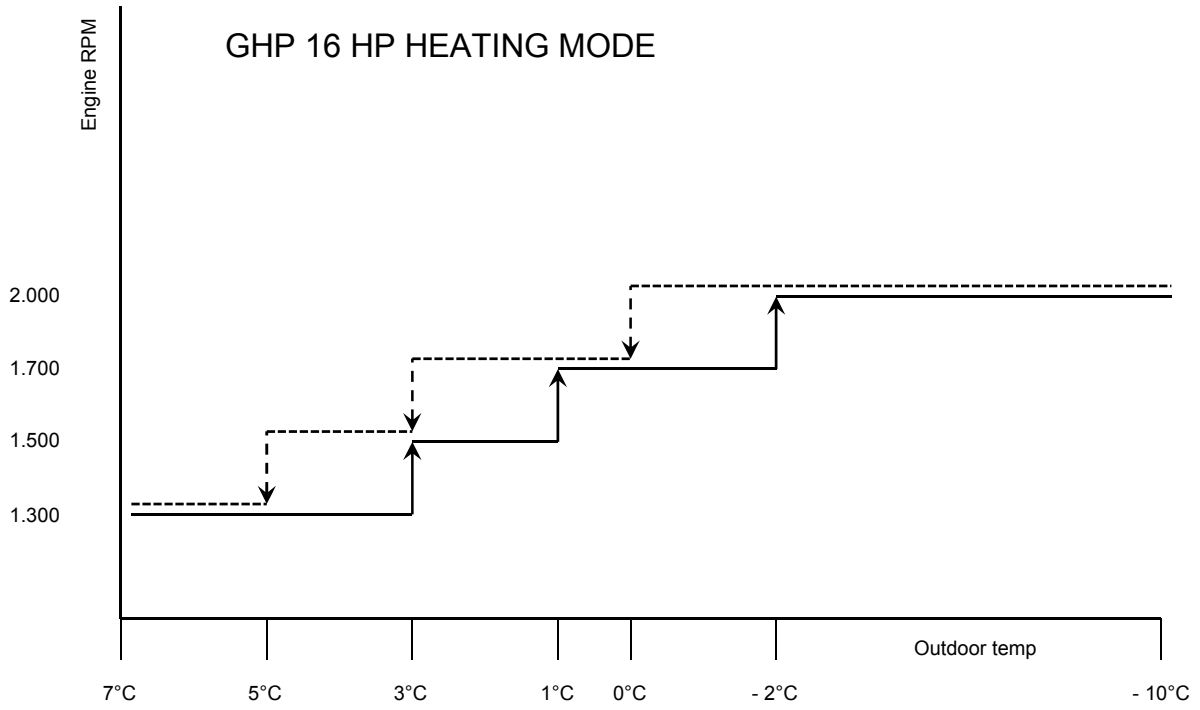

English

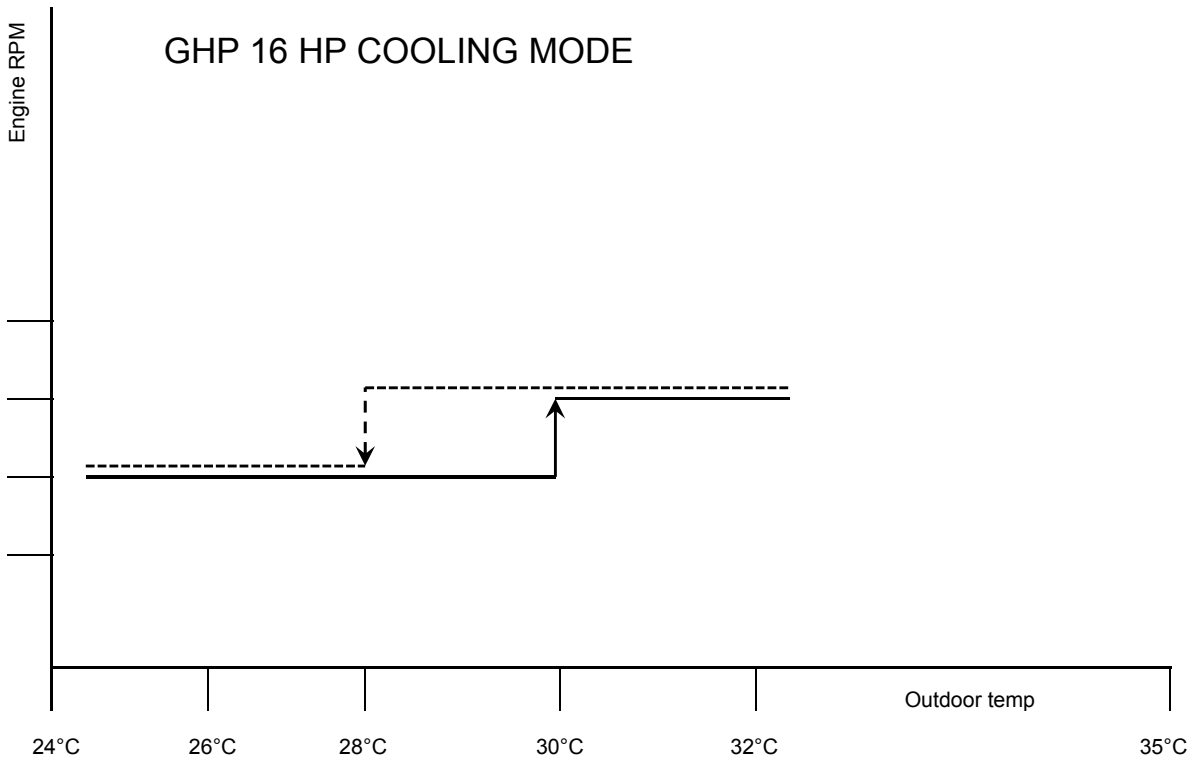

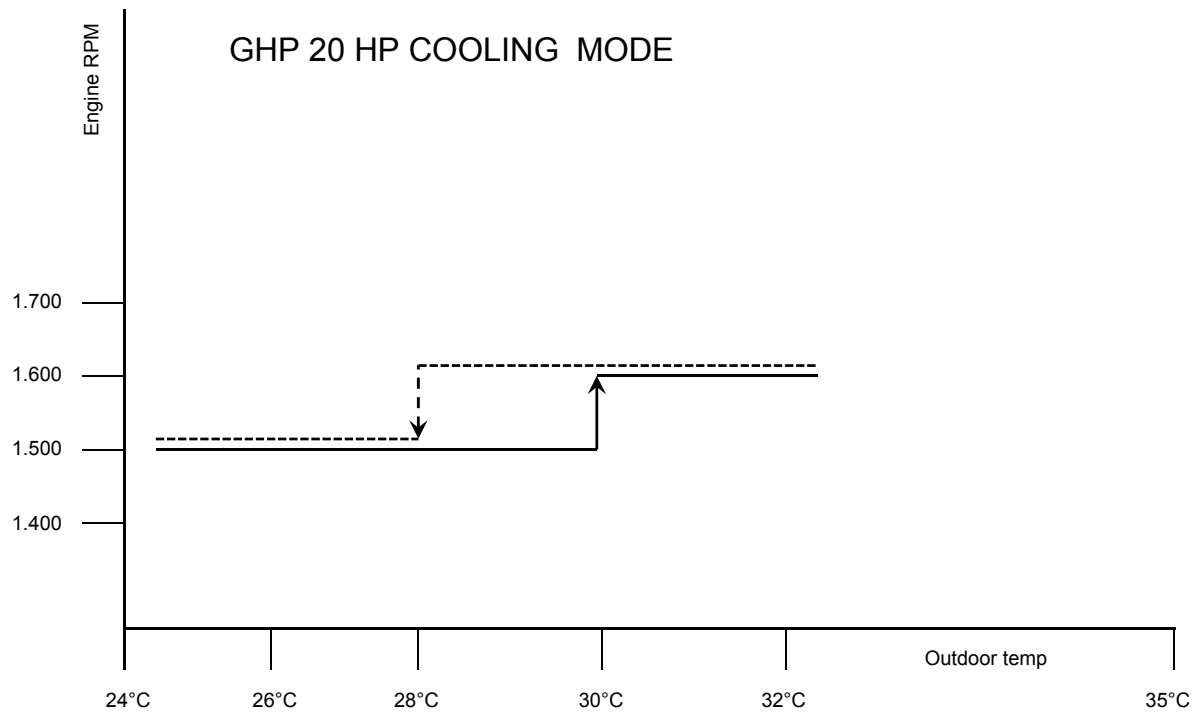
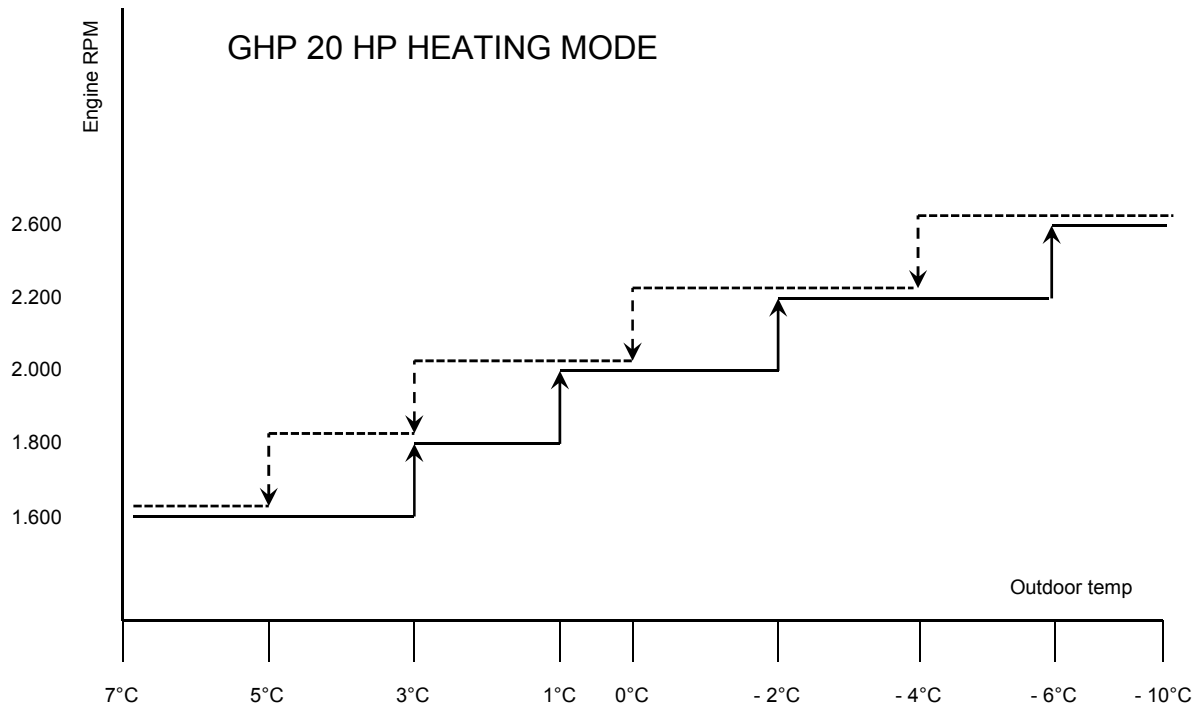

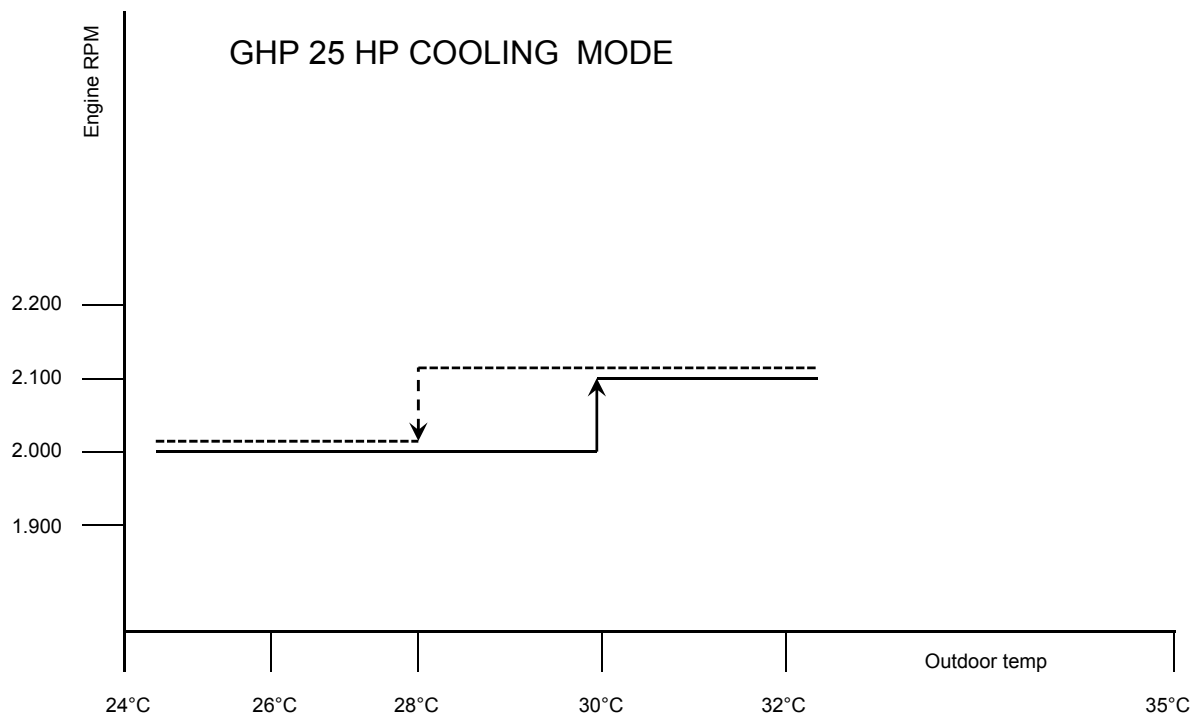
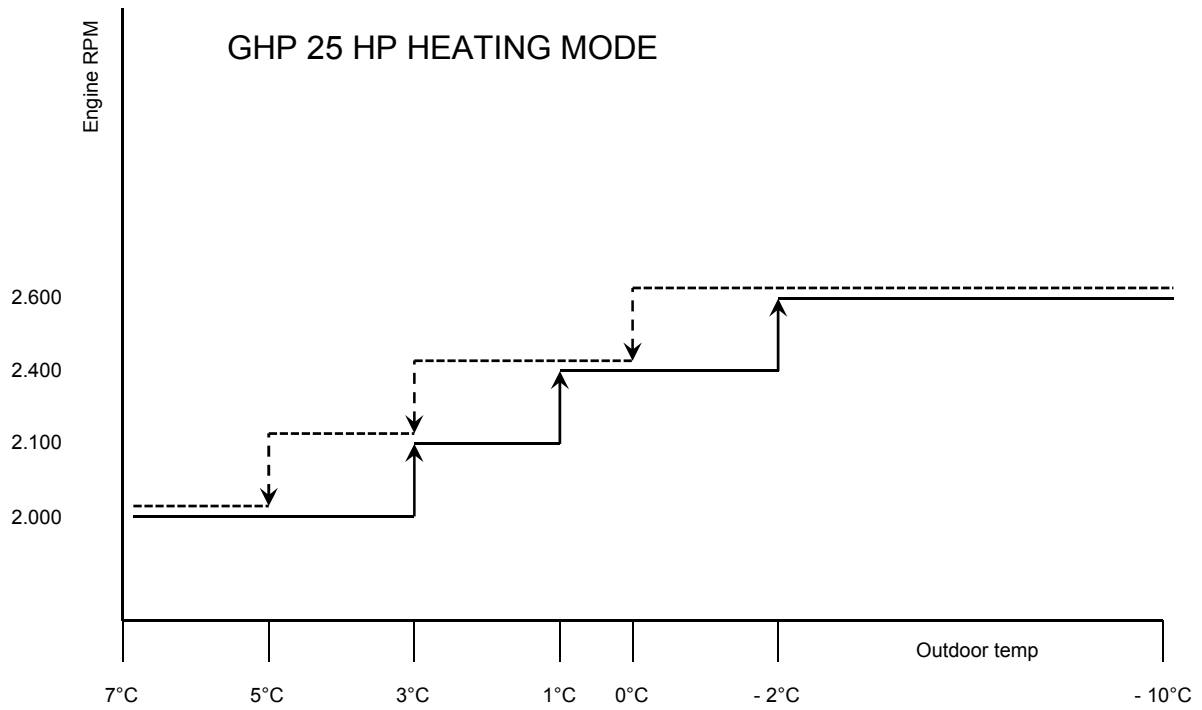

English

18 Contact specifications

Digital Input

AL-COM AL-ON	Dry contact (closed 0 Volt – open 24 VAC)
REM	Dry contact (closed 0 Volt – open 24 VAC)
REM1	Dry contact (closed 0 Volt – open 24 VAC)
FL-COM FL-ON	Dry contact (closed 0 Volt – open 24 VAC)
PD-COM PD-ON	Dry contact (closed 0 Volt – open 24 VAC)
IDLC11-14 IDL11 (From the board to the PLC)	15 VDC
IDLC11-14 IDL12 (From the board to the PLC)	15 VDC

Digital Output

KP (pump relay)	Open 24 VAC
C H/C	Dry contact (closed 0 Ohm)
C7-9 NO13 (contact T1 T2)	Dry contact (closed 0 Ohm)
C13-15 NO13 (contact DI1 Valve Driver)	Dry contact (closed 0 Ohm)
Alarm	Dry contact (closed 0 Ohm)
C4-6 NO5 (Power supply board)	Dry contact (closed 0 Ohm)

Components

PCB – connector X1A	When supplied 24 VAC
Driver Valve GoG	When supplied 24 VAC
Pump	When supplied 230 VAC single phase

Analogic Input

NTC probe	See “table resistor temperature sensor values NTC”
Probe 4-20 mA Pressure	Linear 4 mA = 0 BAR 20 mA = 44,8 BAR

19 Table temperature - sensor NTC resistor

Temperature °C	Resistance value		
	KΩ	KΩ	KΩ
-5	34,66	33,90	33,15
-4	33,15	32,44	31,73
-3	31,72	31,05	30,39
-2	30,36	29,73	29,11
-1	29,06	28,48	27,89
0	27,83	27,28	26,74
1	26,65	26,13	25,62
2	25,52	25,03	24,55
3	24,44	23,99	23,54
4	23,42	23,00	22,57
5	23,42	23,00	22,57
6	21,53	21,15	20,78
7	20,64	20,30	19,95
8	19,81	19,48	19,15
9	19,01	18,70	18,39
10	18,25	17,96	17,67
11	17,51	17,24	16,97
12	16,81	16,56	16,30
13	16,14	15,90	15,67
14	15,50	15,28	15,06
15	14,89	14,69	14,48

English

20 Characteristics sensor gas and liquid pipe

SENSOR GAS PIPE

Temperature (°C)	Resistance (Ω)
-10	112.0 k
0	65.8 k
10	40.0 k
20	25.0 k
30	16.1 k
40	10.6 k
50	7.2 k

SENSOR LIQUID PIPE

Temperature (°C)	Resistance (Ω)
-10	112.0 k
0	65.8 k
10	40.0 k
20	25.0 k
30	16.1 k
40	10.6 k
50	7.2 k

YOSHI®

Experience & Technology



AISIN



ANIMA®



4830 Transport Drive
Dallas, TX 75247, 214-638-6010