

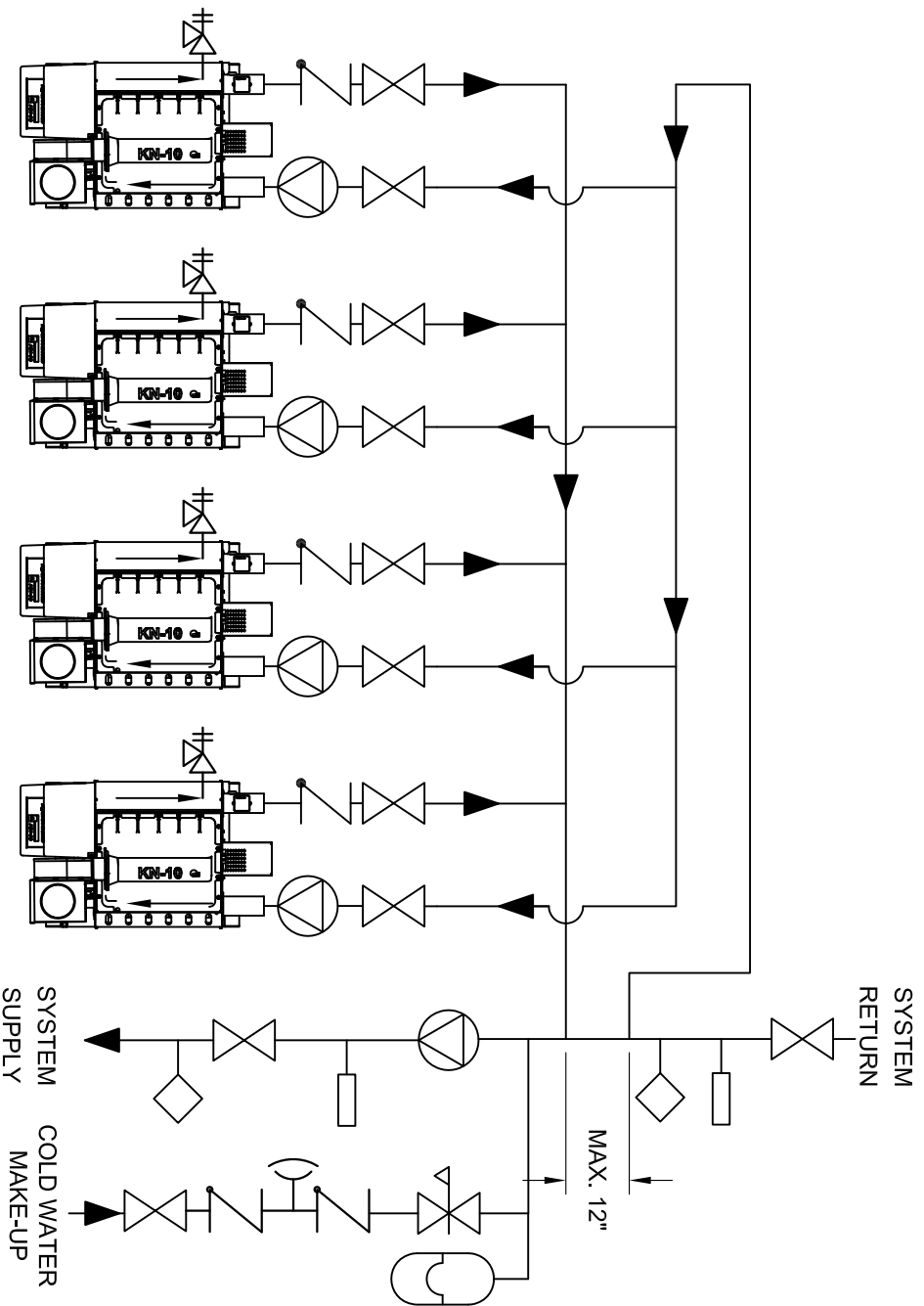







MULTIPLE BOILER PRIMARY/SECONDARY PIPING

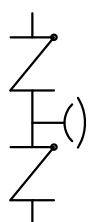
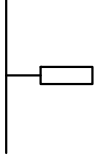
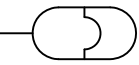
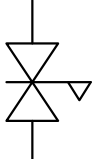

- 
Pump
- 
Gate Valve
- 
Check Valve
- 
Backflow-Prevention Device
- 
Pressure Relief Valve
- 
Thermometer
- 
Expansion Tank
- 
Aquastat
- 
Pressure Reducing Valve