

ARROW

EXTRUDED ALUMINUM LOUVERS
2" - 4" - 6" DEEP

TYPE
ROUND
SEMI-ROUND

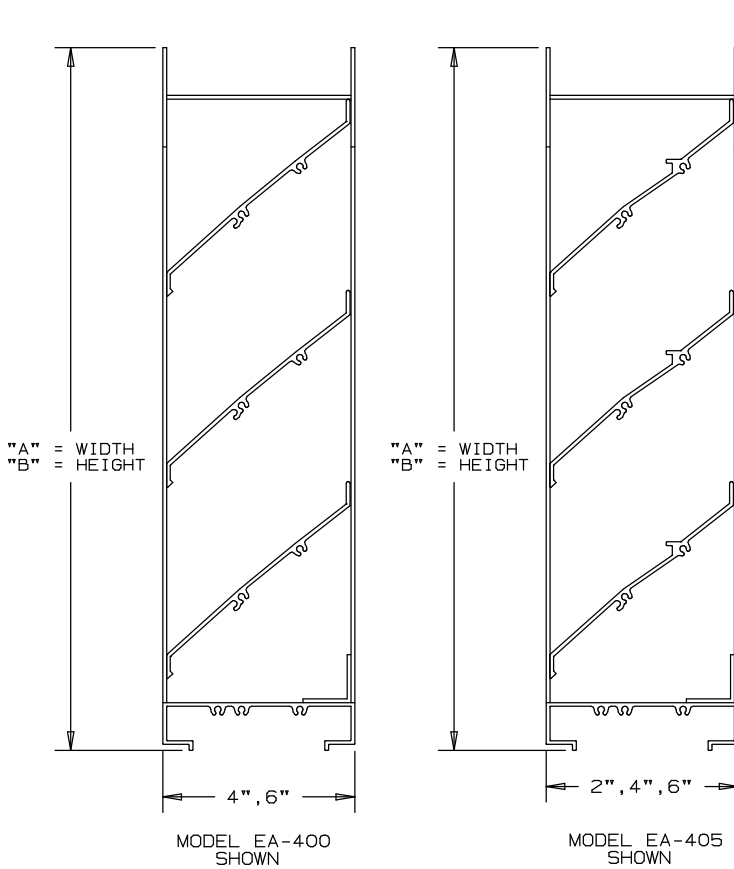

NOT TO SCALE

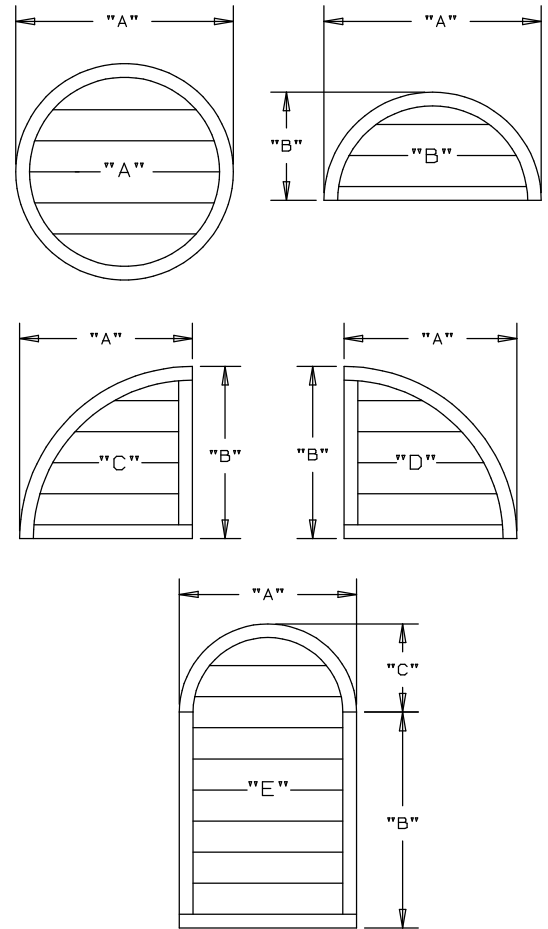

SPECIFICATIONS

- FRAME: EXTRUDED ALUMINUM.
- BLADES: EXTRUDED ALUMINUM.
- SCREENS: FURNISHED WHEN INDICATED.
- FINISH: MILL.
- NOTE: SEE SPECIFIC LOUVER DATA SHEETS FOR ADDITIONAL INFORMATION.

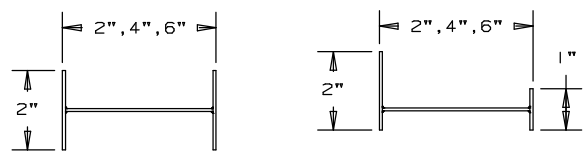

CHANNEL

FLANGED

4" DEEP FRAMES SHOWN
OTHER FRAMES AVAILABLE

NOMINAL DEDUCTIONS WILL BE MADE TO OPENING SIZES GIVEN.

ITEM	QTY.	"A"	"B"	"C"	"D"	"E"	"A"	"B"	"C"	TYPE	LOC	MULL	MODEL	UNION MADE
		LOUVER SHAPE					LOUVER SIZE							



ARROW UNITED INDUSTRIES
A DIVISION OF MESTEK, INC.
314 RIVERSIDE DRIVE
WYALUSING, PA 18853
TEL: (570) 746-1888 FAX: (570) 746-9286
WEB ADDRESS: WWW.ARROWUNITED.COM

AGENT: _____

ARCH./ENG. : _____

CONTR. : _____

PROJECT : _____

EDR: _____ ECN: _____ JOB: _____

DATE: _____ DWN. : _____ DWG. : _____

ARROW

EXTRUDED ALUMINUM LOUVERS 1 1/2" - 2" - 4" - 6" DEEP

TYPE TRIANGULAR

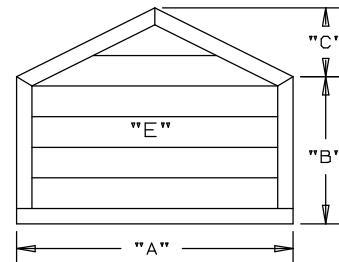
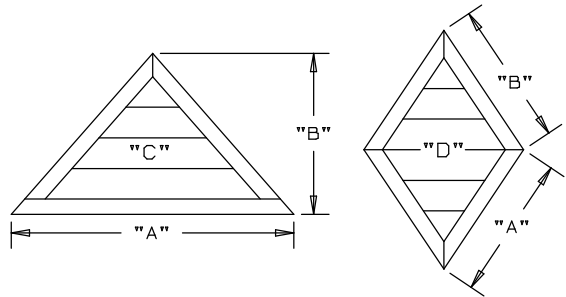
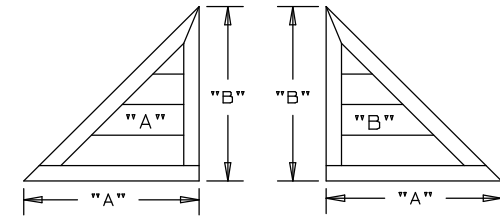
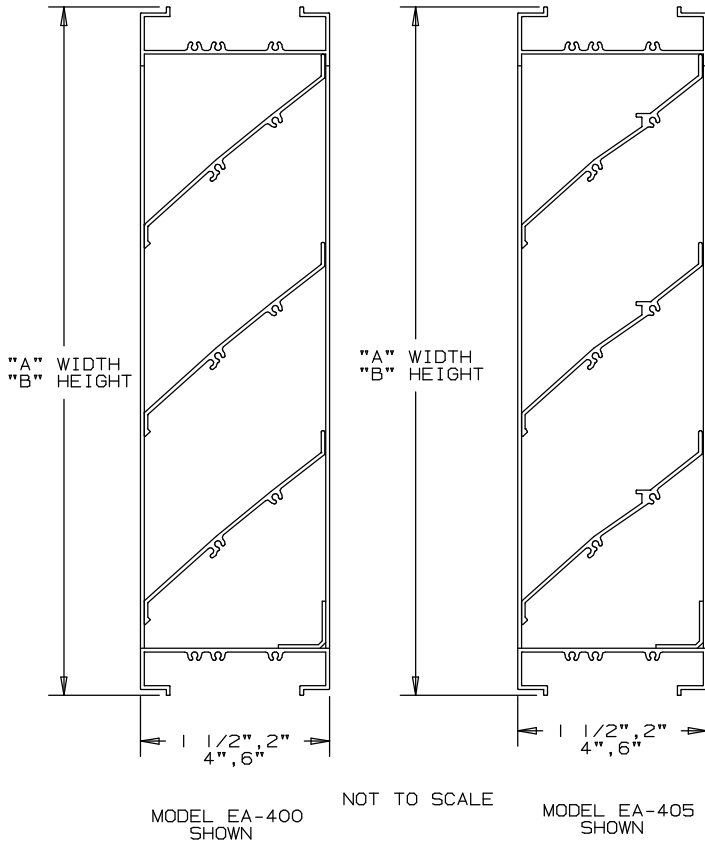

OTHER MODELS AVAILABLE
EA-200, EA-605, EA-150

SPECIFICATIONS

- FRAME: EXTRUDED ALUMINUM.
- BLADES: EXTRUDED ALUMINUM.
- SCREENS: FURNISHED WHEN INDICATED.
- FINISH: MILL.
- NOTE: SEE SPECIFIC LOUVER DATA SHEETS FOR ADDITIONAL INFORMATION.

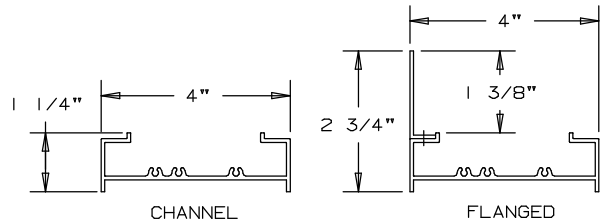

4" DEEP FRAMES SHOWN
OTHER FRAMES AVAILABLE

NOMINAL DEDUCTIONS WILL BE MADE TO OPENING SIZES GIVEN.

ITEM	QTY.	"A"	"B"	"C"	"D"	"E"	LOUVER SHAPE			LOUVER SIZE			TYPE	LOC	MULL	MODEL	UNION MADE
							"A"	"B"	"C"	"A"	"B"	"C"					

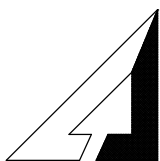

ARROW UNITED INDUSTRIES
A DIVISION OF MESTEK, INC.

314 RIVERSIDE DRIVE
WYALUSING, PA 18853

TEL: (570) 746-1888 FAX: (570) 746-9286

AGENT: _____

ARCH./ENG.:

CONTR.:

PROJECT:

EDR:

ECN:

JOB:

DATE:

DWN.:

DWG.:

ARROW FORMED STEEL LOUVERS 2" - 4" - 6" DEEP

TYPE ROUND SEMI ROUND

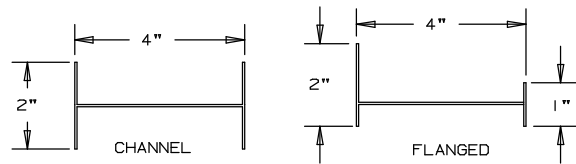
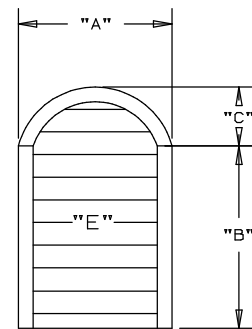
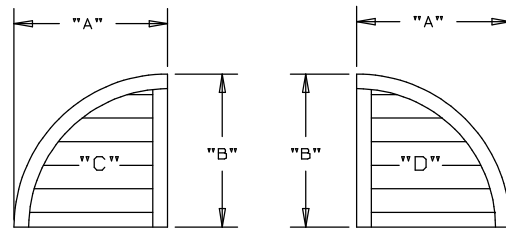
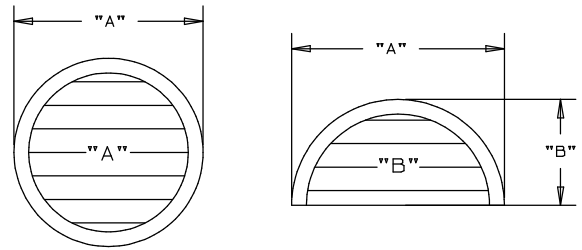
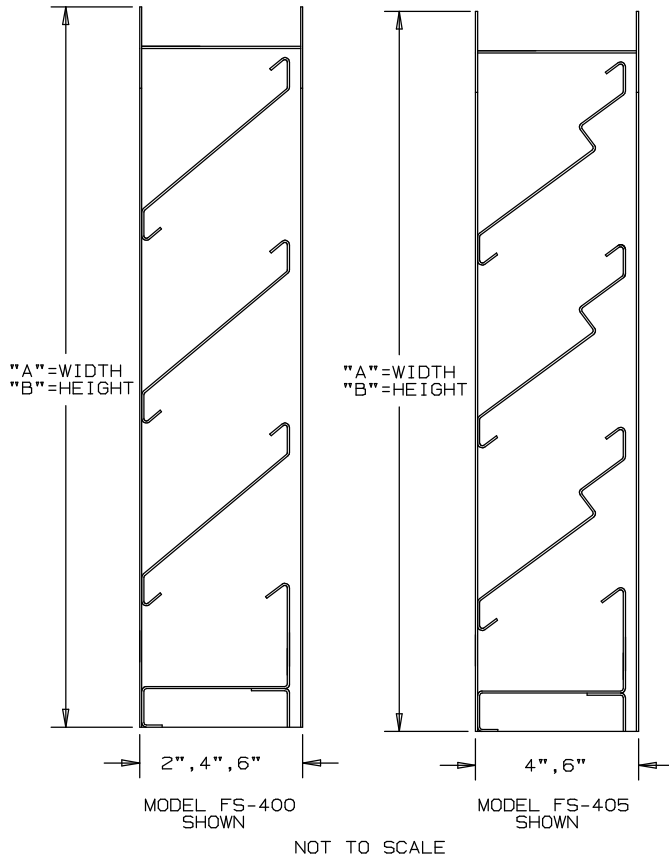

TYPICAL FABRICATED RADIUS CONFIGURATION

4" DEEP FRAMES SHOWN
OTHER FRAMES AVAILABLE

SPECIFICATIONS:

FRAME: FABRICATED STEEL/ FORMED STEEL.
BLADES: FORMED STEEL.
SCREENS: FURNISHED WHEN INDICATED.
FINISH: MILL.

NOTE: SEE SPECIFIC LOUVER DATA SHEETS
FOR ADDITIONAL INFORMATION.

NOMINAL DEDUCTIONS WILL BE MADE TO THE OPENING SIZE GIVEN.

ITEM	QTY.	"A"	"B"	"C"	"D"	"E"	"A"	"B"	"C"	TYPE	LOC	MULL	MODEL	 UNION MADE
		LOUVER SHAPE					LOUVER SIZE			SCREENS				

ARROW UNITED INDUSTRIES
A DIVISION OF MESTEK, INC.
314 RIVERSIDE DRIVE
WYALUSING, PA 18853
TEL: (717) 746-1888 FAX: (717) 746-9286
Web Address: www.arrowunited.com

AGENT: _____

ARCH. /ENG. :
CONTR. :
PROJECT :
EDR: _____ ECN: _____ JOB: _____
DATE: _____ DWN. : _____ DWG. : _____

ARROW FORMED STEEL LOUVERS 2" - 4" - 6" DEEP

TYPE TRIANGULAR

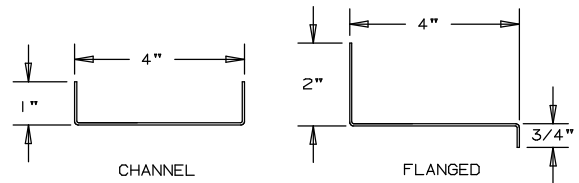
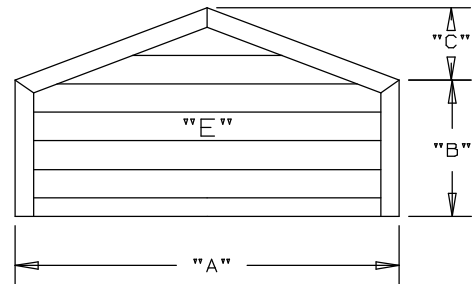
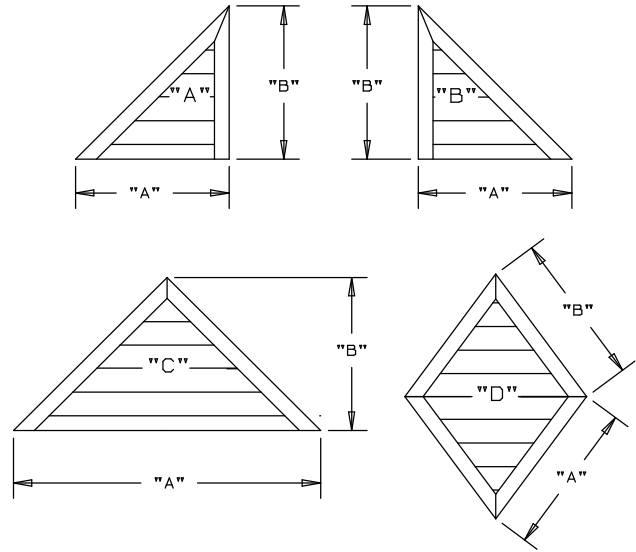
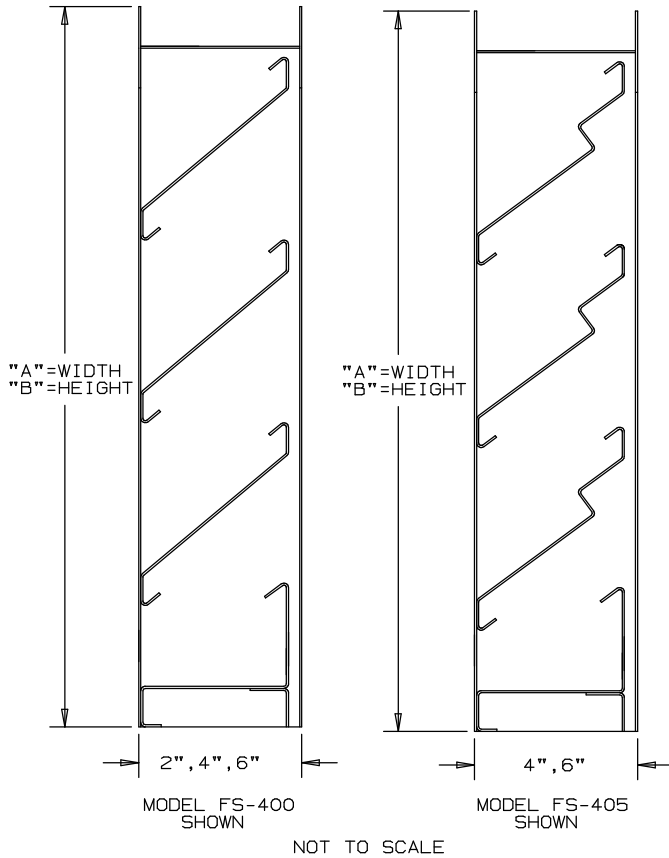

4" DEEP FRAMES SHOWN
OTHER FRAMES AVAILABLE

SPECIFICATIONS:

FRAME: FORMED STEEL.
BLADES: FORMED STEEL.
SCREENS: FURNISHED WHEN INDICATED.
FINISH: MILL.

NOTE: SEE SPECIFIC LOUVER DATA SHEETS
FOR ADDITIONAL INFORMATION.

NOMINAL DEDUCTIONS WILL BE MADE TO THE OPENING SIZE GIVEN.

ITEM	QTY.	"A"	"B"	"C"	"D"	"E"	"A"	"B"	"C"	TYPE	LOC	MULL	MODEL	 UNION MADE
		LOUVER SHAPE					LOUVER SIZE			SCREENS				

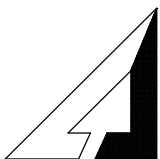

ARROW UNITED INDUSTRIES
A DIVISION OF MESTEK, INC.

314 RIVERSIDE DRIVE
WYALUSING, PA 18853

TEL: (717) 746-1888 FAX: (717) 746-9286

Web Address: www.arrowunited.com

AGENT: _____

ARCH./ENG.:

CONTR.:

PROJECT:

EDR:

ECN:

JOB:

DATE:

DWN.:

DWG.: