

ARROW MOUNTING DETAILS: HAND CRANK OPERATORS

TYPE 0-24 & 0-25

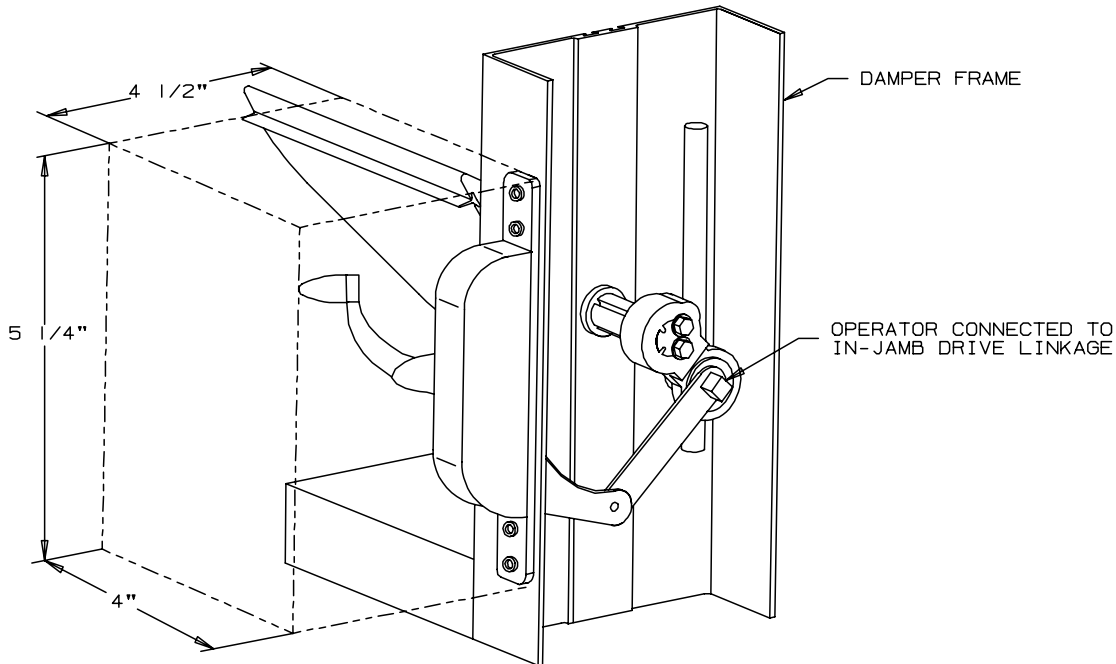

PHANTOM LINES
DENOTE ENVELOPE
AREA REQUIRED
FOR OPERATOR
CLEARANCE

0-24 HAND CRANK OPERATOR
FOR UNITS UP TO 10 SQ. FT.

NOTE:
POSITION OF OPERATOR MAY
VARY SLIGHTLY ACCORDING
TO CONSTRUCTION FOR
VARIOUS ARROW LOUVER
OR DAMPER MODELS

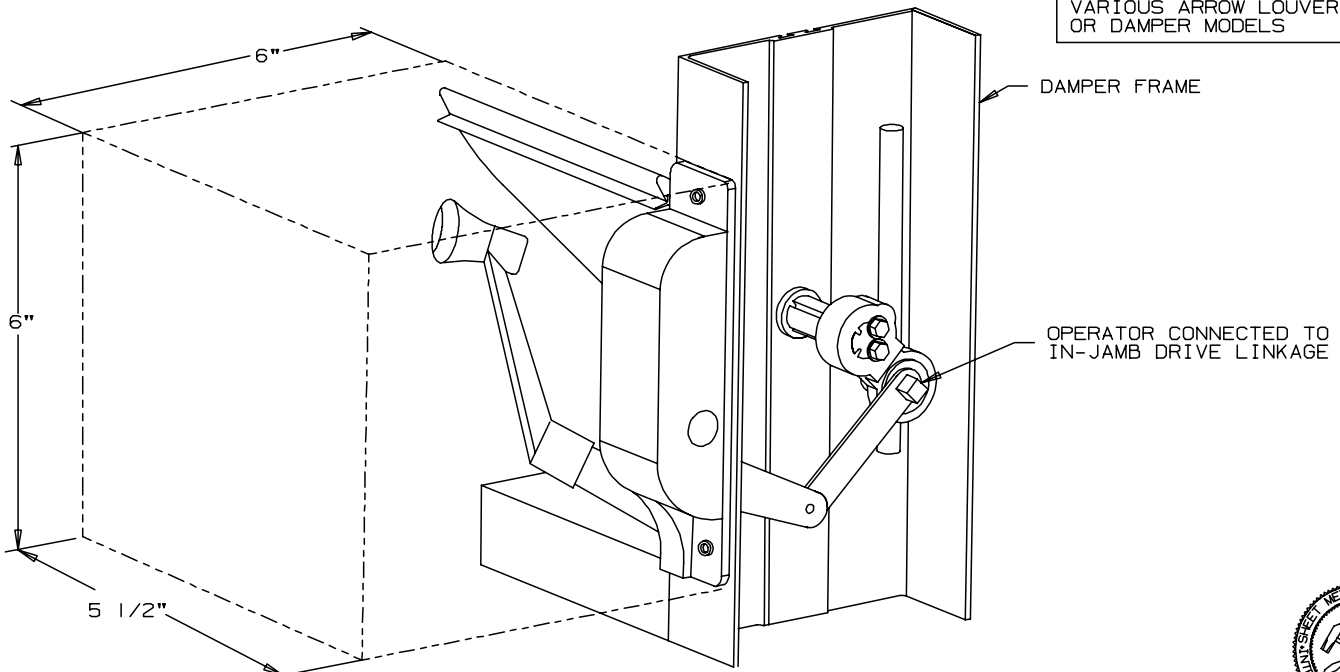

0-25 HAND CRANK OPERATOR
FOR UNITS UP TO 32 SQ. FT.



UNION MADE

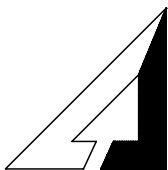

ARROW UNITED INDUSTRIES
A DIVISION OF MESTEK, INC.

450 RIVERSIDE DRIVE
WYALUSING, PA 18853

TEL: (570) 746-1888 FAX: (570) 746-9286
WEB ADDRESS: WWW.ARROWUNITED.COM

AGENT: _____

ARCH./ENG. :

CONTR. :

PROJECT :

EDR: ECN: JOB:

DATE: DWN. : DWG. :