

Evaporative Cooling Modules

WCD Series

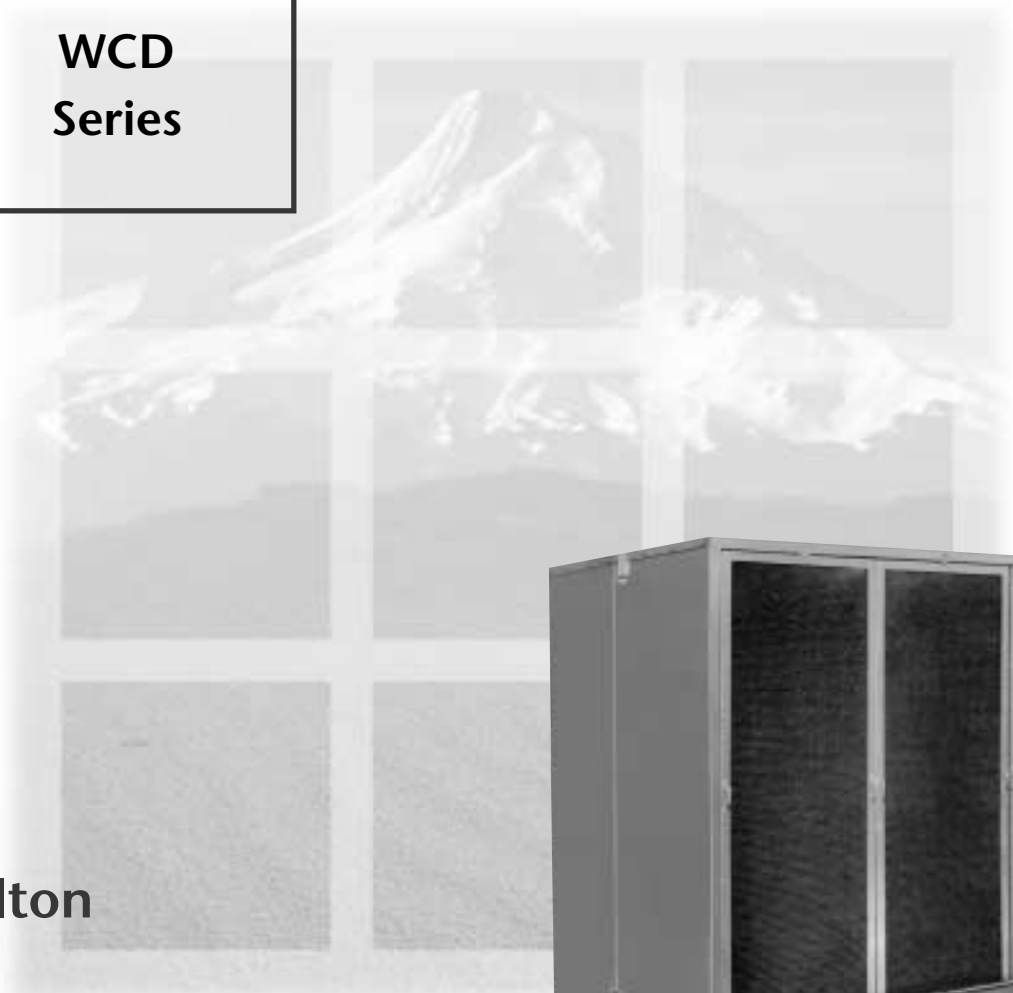

Alton

Keeps You

Cool

For Less



Alton®

TURBOCELL WCD SERIES

EVAPORATIVE COOLING MODULES

THE LATEST IN COOLING TECHNOLOGY

In many types of industries where efficient, low-cost cooling is essential, "Alton" has been the word for experience, reliability and innovation since 1946. Alton offers its service oriented expertise and reliability to ensure the high quality standards that architects, engineers, building owners, and plant managers have come to rely on from one of the industry leaders.

ALTON has the facilities, resources and people to assure Leadership and Quality in research and development, design and engineering, manufacturing and service.

To all this, add the professional planning assistance provided by ALTON. We work with architects, engineers, building owners and plant managers to help select the right equipment, analyze the best way to install it and back it with service.

BENEFITS OF EVAPORATIVE COOLING

Cooling without the cost of refrigeration . . . Cooling nature's way with water eliminates the cost of expensive refrigeration systems and reduces operating and maintenance costs. Installation is simple and inexpensive.

Big Space or Small.

You can cool a small area or a big plant. With capacities from 5,000 to 64,000 CFM you have the flexibility to put cool air right where you want it. Air changes can be planned for one every 30 seconds to one every five minutes (12 to 120 times an hour) – depending on climate conditions and operational requirements.

Comfort Anywhere.

On a humid day in New Orleans the Turbocell can reduce the 93°F air to a relatively cool 79°-80°F. In drier Tucson, 104° outside air can be brought down 30°F. The hotter and drier the air, the greater the reduction in temperature. That means maximum comfort when you need it most.

HOW THE TURBOCELL EVAPORATIVE COOLING MODULE WORKS

Whenever water is evaporated, heat is absorbed. Wet the back of your hand, then blow on it. The skin surface is immediately cooler. This demonstrates the basic principle of evaporative cooling. The Turbocell works by drawing outside air through its uniquely designed cross-fluted Turbodek media. A constant low-volume water flow saturates the media from above. Due to its internal geometry, a turbulent mix of air and water is created which optimizes heat transfer. The water is evaporated and the air is simultaneously cooled. An air washing effect is also created which removes most dust and dirt from the air stream before the air flows into the work area providing a clean, cool environment.

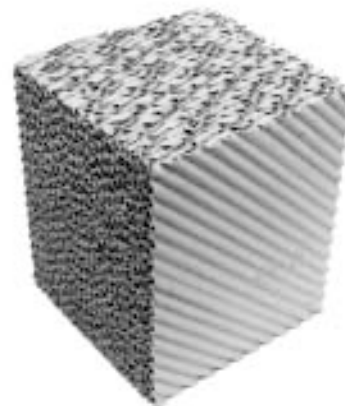

TURBODEK MEDIA

WHY EVAPORATIVE COOLING IS COMFORTABLE

Lowers Temperature.

The Turbocell pumps in cool air lowering room temperature.

Lowers the Temperature You Feel.

The rapid moving air produced by the Turbocell increases skin surface evaporation. This results in effective cooling meaning people feel 3 to 5 degrees cooler than the temperature read from a thermometer.

Carries Away Radiated Heat.

A constant flow of cool air removes heat from the work place leaving a more comfortable surrounding.

Fresh Air.

The Turbocell provides fresh, revitalizing air, forcing stale air out.

Cleans Air.

The Turbocell system cleans air by removing dust, dirt, pollen, and foreign matter creating a more refreshing environment.

TURBOCELL FEATURES

(A) Cooling Media.

The Turbodek media with its unique cross-fluted design not only offers a higher cooling efficiency, up to 90% in the 400 fpm range, but is more durable and its self cleaning action extends the life span years beyond that of most conventional media. Optional Fiberdek is U.L. approved with a U.L.900, class 2 rating.

(B) Optional Maxaire Prefilter.

Keeps bugs out, reduces odor-producing algae by keeping out sunlight and helps minimize the accumulation of dust, dirt and other airborne particles from rapidly collecting in the water tank.

(C) Washer Cabinet and Water Pan.

Construction of 304 Stainless Steel.

(D) Float Operated Valve.

Maintains water level in tank, $\frac{3}{8}$ " parts are corrosion-resistant and replaceable.

(E) Bleed-off Valve.

Manually adjustable, brass construction, $\frac{1}{4}$ ", reduces mineral buildup, helps prevent media clogging thus extending media life.

(F) Water Distribution Manifold.

Heavy-duty schedule 40 PVC with metered orifices, and removable end caps for easy cleaning.

(G) Bottom Drain.

Drain pan is cross broke to center with stainless steel nipple welded in place, allows for complete drainage of water pan.

(H) Water Regulator Valve.

Brass construction, water flow can be field set.

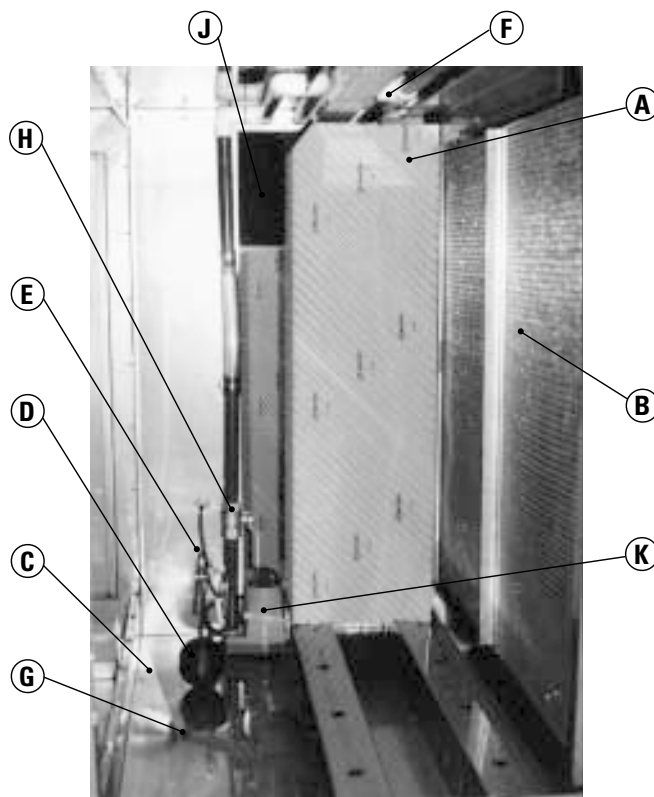

(J) Access Panel.

Full size side panel provides easy access to pump, float valve, water regulator valve and cooling media that can be easily removed.

(K) Pump.

Submersible, centrifugal, U.L. listed, dielectric oil-filled motor, lubricated for life. Lightweight and compact with strainer to prevent clogging. Available for 115V or 230V, single-phase operation.

EQUIPMENT OPTIONS

Fiberdek Media - A woven glass fiber media that has a UL 900, class 2 fire rating. Evaporative efficiency is equivalent to that for Turbodek media.

Duradek Media - Uses the same cellulose media as Turbodek, but includes a bitumastic coating on the leading edge to permit repeated cleanings and inhibit algae growth. Evaporative efficiency is equivalent to that for Turbodek media.

Manual Fill and Drain Kit - Consists of a remote fill/drain switch; two-way drain line solenoid valve; three-way supply line solenoid valve; and a water level float switch. Can be furnished with or without a freeze-protection thermostat.

Automatic Fill and Drain Kit - Includes all of the components of the manual kit plus a freeze-protection thermostat.

APPLYING A TURBOCELL

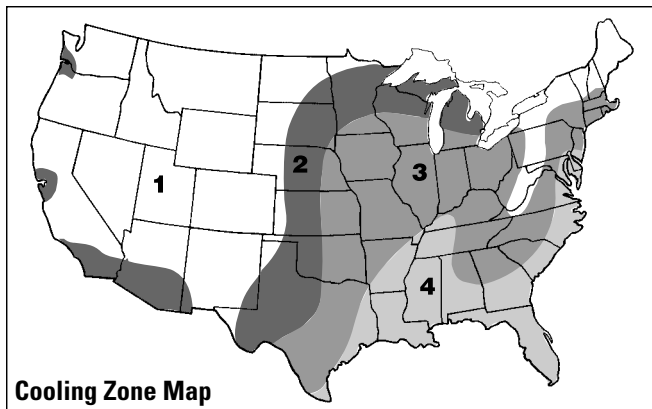

The Turbocell can be used to area cool or spot cool. Area cooling is used to cool an entire work area where workers constantly move about and cooling requirements do not vary greatly from one location to the next. Spot cooling is used when building volume is large and workers are located near machines that give off heat. Cool air from the Turbocell is distributed through ductwork and discharged directly on the workers.

AIR CHANGE TABLE

Interior Heat Load	Sun Protection	Minutes Per Air Change			
		Zone 1	Zone 2	Zone 3	Zone 4
Excessive	Poor	1½	1	¾	½
	Good	2	1½	1	¾
Normal	Poor	2	1½	1	¾
	Good	2	2	1½	1

AREA COOLING:

- Step 1.** Select the zone from the "Cooling Zone Map."
- Step 2.** Decide if the interior heat load is "Normal" or "Excessive." "Normal" means no heat producing equipment or large crowds. "Excessive" means an area with heat generating equipment or a large number of people. Examples of heat generating equipment are large motors, stoves, ovens, or industrial process equipment.
- Step 3.** Decide if the area to be cooled is protected from the heat of the sun. A "Good" sun protection is one where the building is insulated or the exterior walls are shaded. Windows do not face the sun during the heat of the day. A "Poor" sun protection is one where the building is uninsulated, sun beams down on the building and windows face the sun during the afternoon hours.
- Step 4.** Refer to the "Air Change Table" and determine the number of minutes required per air change.
- Step 5.** Calculate the building size. (Length in ft.) x (Width in ft.) x (Height in ft.) = ft³. **Note:** If the building has a very high ceiling, use a height of 15 to 18 feet. The Turbocell should be installed so it discharges into the lower part of the room while an exhaust fan draws air from the upper level.

- Step 6.** Reduce the building size by the room taken up with machinery, inventory, etc. (Building size in ft³) – (Machinery, etc. in ft³) = (Space to cool in ft³).
- Step 7.** Divide the (Space to cool in ft³) from step 6 by the (Number of minutes required per air change) from step 4. This gives the CFM rating that the Turbocell module must handle.

EXAMPLE:

- Step 1.** Small radiator factory located in Mobile, AL. See "Cooling Zone Map" to get Zone 4.
- Step 2.** Factory has solder dip tanks that give off heat. Interior heat load is "Excessive."
- Step 3.** Factory is exposed to sun throughout the day. Sun protection is "Poor."
- Step 4.** From "Air Change Table" get ½ minute per air change.
- Step 5.** Calculate the size of the factory. (50 ft. length) x (30 ft. width) x (10 ft. height) = 15,000 ft³.
- Step 6.** Room occupied by machinery and inventory is 2,200 ft³. (15,000 ft³) - (2,200 ft³) = 12,800 ft³.
- Step 7.** CFM rating = $\frac{12,800 \text{ ft}^3}{\frac{1}{2} \text{ min.}} = 25,600 \text{ CFM}$

SPOT COOLING:

The volume of air per work station depends on the amount of activity, the degree of heat to overcome, and the distance between workers and air discharge. The volume of air usually varies from 500 to 5,000 CFM and the air velocity at the worker should range from 400-1000 FPM. The cool air discharge should be no more than 4-10 feet from the worker and be directed towards the upper body area. The air outlet should be adjustable so the direction of flow can be controlled. Due to the complexity of sizing units for specific spot cooling applications please contact the Alton Sales Department for assistance.

Definitions

- CFM = Airflow through the WCD module, cubic ft./min
 - FA = Face area of the WCD module, sq. ft.
 - FV = Face velocity through the WCD module, fpm
 - ODB = Outside air dry bulb temperature, °F
 - OWB = Outside air wet bulb temperature, °F
 - LAT = Dry bulb temperature of air leaving the module, °F
 - APD = Air pressure drop across the module, inches w.c.
 - EE = Evaporative efficiency, determined as:
- $$EE = \frac{ODB - LAT}{ODB - OWB}$$

SELECT A WCD MODULE

SELECTION PROCEDURE:

Using CFM, select WCD module from WCD Selection Table and read Face Area, FA.

Calculate Face Velocity, $FV = CFM/FA$.

Using Face Velocity, look up Evaporative Efficiency, EE, from chart.

Calculate $LAT = ODB - EE \times (ODB - OWB)$.

Again using Face Velocity, look up Air Pressure Drop, APD, from chart

EXAMPLE:

Select WCD module to handle 29,700 cfm at 91 ODB, 76 OWB; calculate LAT and APD.

SOLUTION:

Select one WCD-300.

Calculate $FV = 29,700/49.5 = 600$ fpm.

From Evaporative Efficiency Chart at 600 fpm: $EE = 0.885$.

Calculate $LAT = 91 - 0.885 \times (91 - 76) = 77.7^\circ F$.

From Air Pressure Drop Chart at 600 fpm: $APD = 0.30$ inches w.c..

WCD SELECTION TABLE

Model	Face Area FA (Sq. ft.)	Minimum CFM	Maximum CFM
WCD-70	13.3	3,990	9,310
WCD-100	17.2	5,160	12,040
WCD-130	20.0	6,000	14,000
WCD-210	32.9	9,870	23,030
(2) WCD-130	40.0	12,000	28,000
WCD-300	49.5	14,850	34,650
(2) WCD-210	65.8	19,740	46,060
(2) WCD-300	99.0	29,700	69,300
(3) WCD-300	148.5	44,550	103,950

Evaporative Efficiency

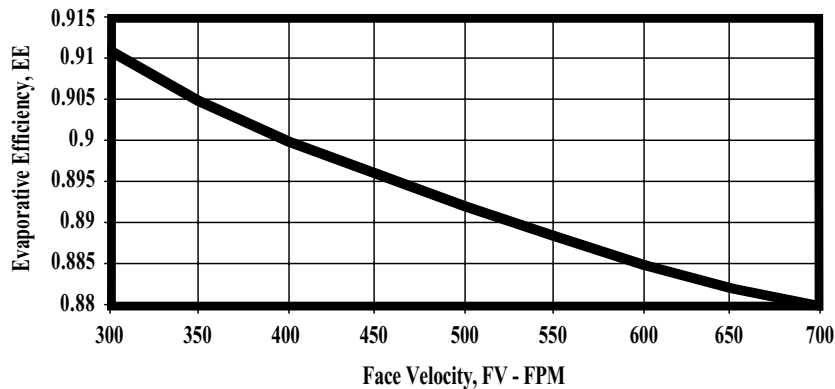

Air Pressure Drop

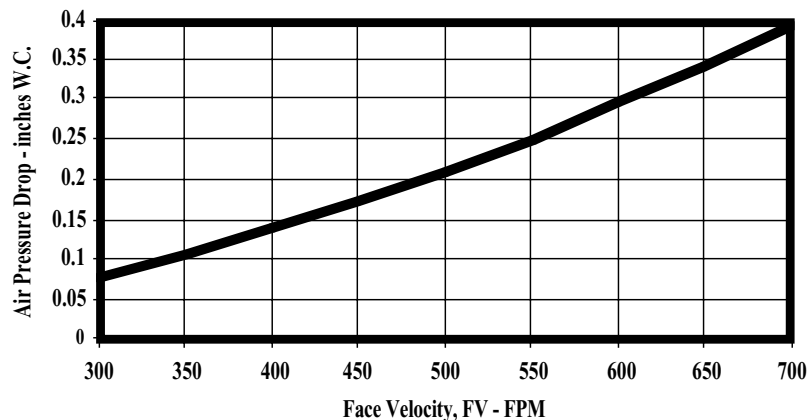

DIMENSIONS – BASIC UNIT

WCD-70, 100, 130, 210, 300

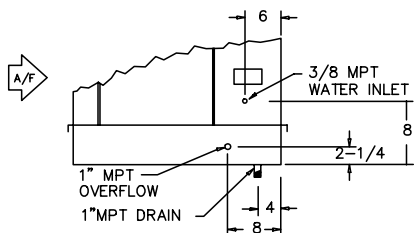

DETAIL "A"

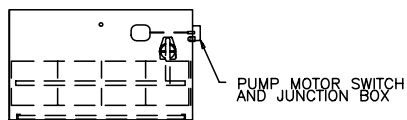

PLAN VIEW

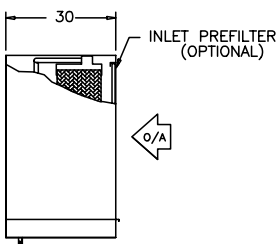

LEFT SIDE VIEW

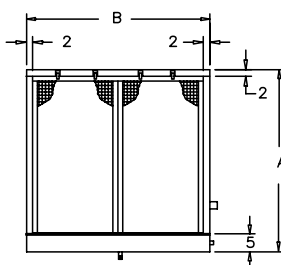

REAR VIEW

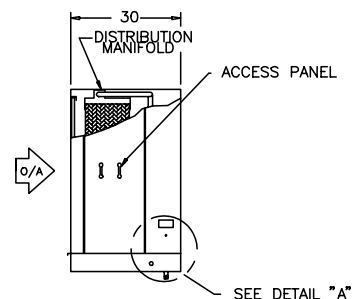

RIGHT SIDE VIEW

MODEL	EVAP. MEDIA	A	B	NET WT.	OPERATING WT.
WCD-70	(4) 12 x 12 x 42-1/2 (1) 2 x 12 x 42-1/2	50	50	155 lbs.	415 lbs.
WCD-100	(4) 12 x 12 x 48 (1) 8 x 12 x 48	56	56	205 lbs.	469 lbs.
WCD-130	(5) 12 x 12 x 54-1/2	62	60	224 lbs.	515 lbs.
WCD-210	(6) 12 x 12 x 67-1/2 (1) 3 x 12 x 67-1/2	75	75	344 lbs.	734 lbs.
WCD-300	(8) 12 x 12 x 78-1/2	86	96	430 lbs.	955 lbs.

Notes:

1. Right hand controls are standard (as shown). Left hand controls available on request.
2. Transition from WCD modules to air handler should follow SMACNA guidelines,

SUGGESTED WIRING DIAGRAM

Single Module

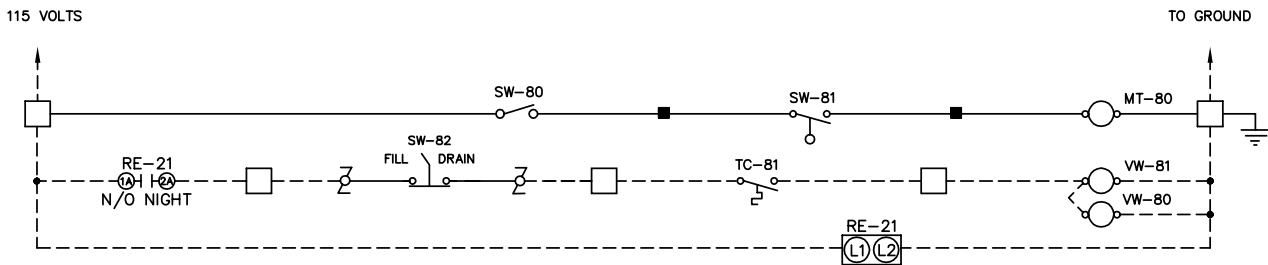

Double Module

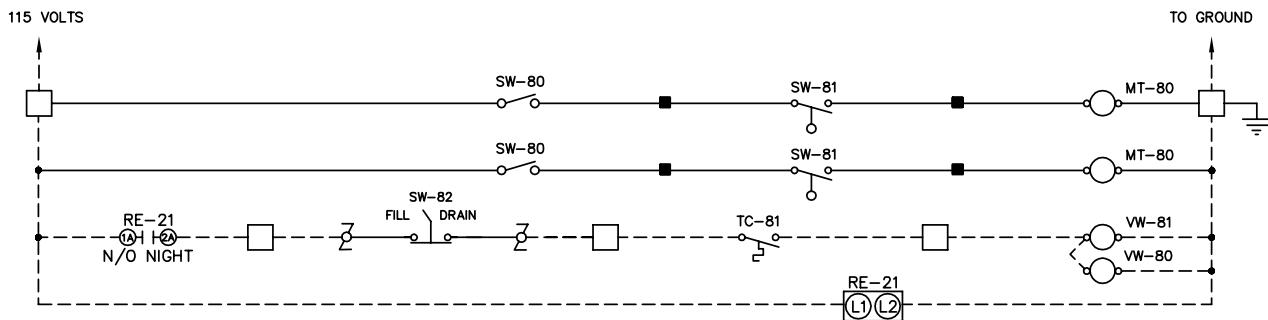

Triple Module

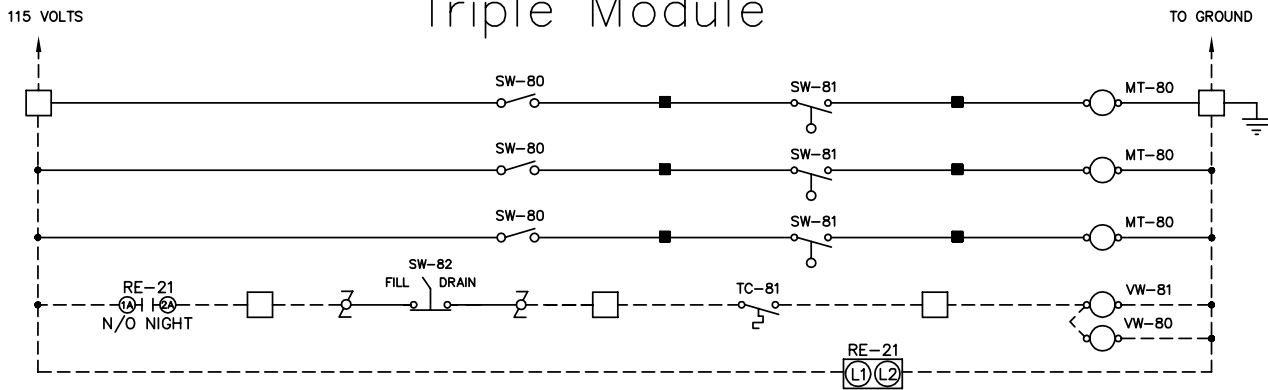

— NOTE —

NOTE: BECAUSE OF SHIPPING RESTRICTIONS
FIELD CONNECTIONS AND/OR WIRING BETWEEN
COMPONENTS OR SECTIONS MAY BE REQUIRED

— COMPONENT IDENTIFICATION —

MT-80 WATER PUMP
RE-21 7-DAY TIME CLOCK
SW-80 PUMP SWITCH
SW-81 WATER LEVEL CUT-OFF SWITCH
SW-82 RESERVOIR DRAIN SWITCH
TC-81 FREEZE PROTECTION THERMOSTAT
VW-82 WATER DRAIN VALVE (N/O)
SW-81 3-WAY WATER SUPPLY VALVE

△ DENOTES COMPONENTS SUPPLIED
AND WIRED BY OTHERS

○ DENOTES COMPONENT TERMINAL
NUMBER AND WIRING

--- DENOTES WIRING BY OTHERS

■ DENOTES JUMPER WIRE

⌘ DENOTES WIRE NUMBER LEADS

⊙ DENOTES WIRE CONNECTION

1-T0-99 TERMINAL BLOCKS-115 VOLT
101-T0-199 TERMINAL BLOCKS-24 VOLT

□ DENOTES CONTROL CABINET
TERMINAL BLOCK & WIRE NUMBER

PLUMBING RECOMMENDATIONS

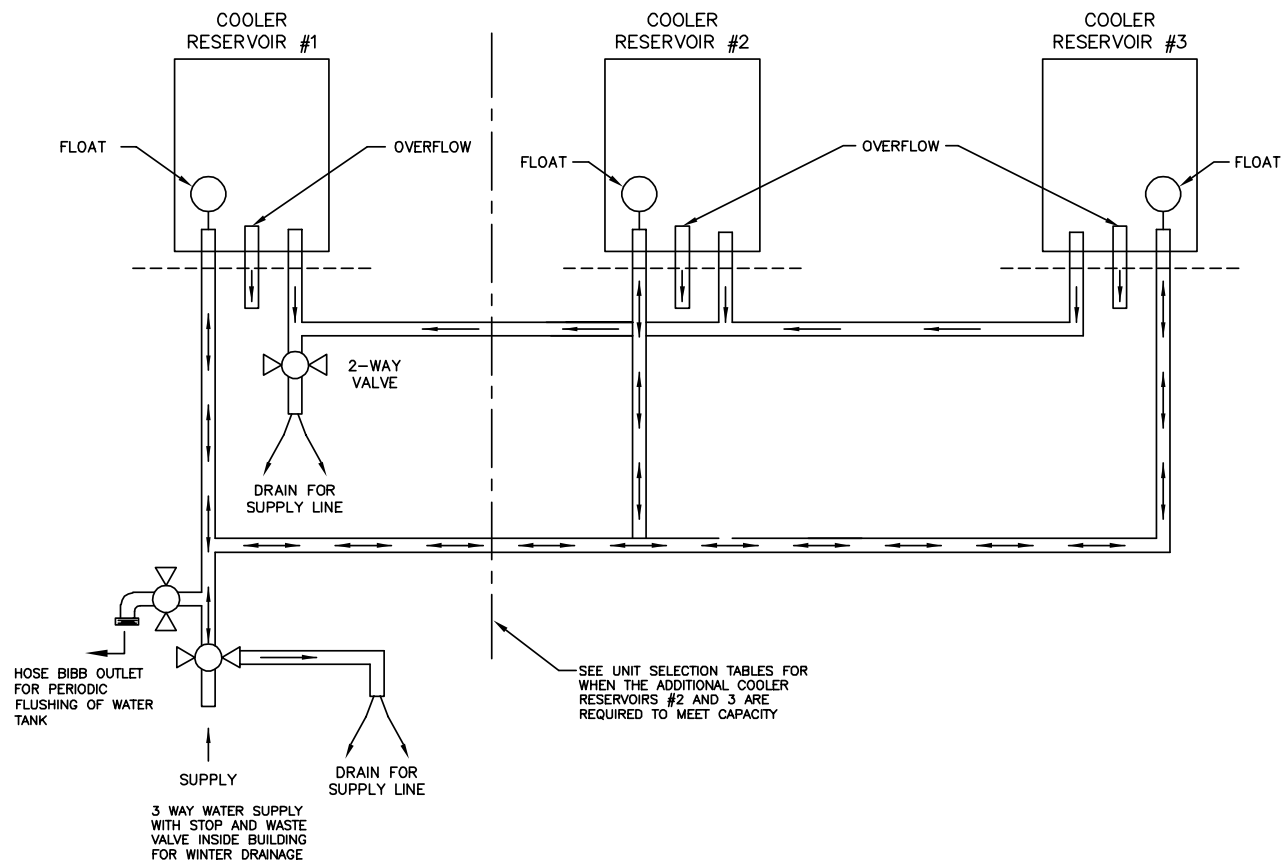

SUPPLY

Each unit requires a 3/8" IPS water supply line to each float valve assembly. Units with two float valve assemblies may be supplied from a 1/2" IPS water supply line. Units with three float valve assemblies may be supplied from a 3/4" IPS water supply line.

MAINTENANCE

It is recommended that the supply piping system include one hose bib outlet, conveniently located on the roof, to facilitate periodic flushing of the water tanks.

FREEZE PROTECTION

The main water supply line should include a stop-and-waste valve inside the building for winter draining.

DRAIN

Each unit is equipped with a 1" drain connection. A 1" gate valve may be attached directly to the unit. Drain piping of waste water must meet local codes. In some cases, it is convenient to carry the 1" drain line down into the building with the valve located at an accessible point to facilitate frequent tank draining.

ENGINEERING SPECIFICATIONS

1.0 The evaporative cooling unit shall be weatherproof and self-contained. It consists of component parts as listed in the following paragraphs. Units shall be Turbocell as sold by Alton located in Dallas, Texas or approved equal.

2.0 TURBOCELL EVAPORATIVE SECTION

2.1 The Turbocell evaporative cooling section shall contain the Turbocell water system, 12" deep cell cooling media, float valve, overflow, and drain connections. Evaporative module to be built separately from the blower section, and no water is to flow into the blower compartment at any time. Evaporative and blower sections are to be firmly attached. Cabinet shall be fabricated from 304 stainless steel. The cooling media shall be easily removable through a full size access panel located on the side of the casing. The side access panel shall also permit easy access to the pump, float, water regulating and bleed-off valves.

2.2 Turbodek cooling media shall be 12" deep fluted cellulose, high efficiency evaporative media, impregnated with insoluble anti-rot chemicals. Maximum air velocity without water carryover is approximately 700 FPM.

2.3 Turbocell water system shall produce a fine spray action which uniformly saturates the 12" deep Turbodek media. Turbocell system to include a submersible pump with U.L. listed, hermetically sealed, dielectric oil-filled motor and Buna-N seal. Horsepower rating of the pump shall not be less than 1/6 HP. Pump to be centrifugal type with suction strainer to prevent the intake of solid matter. Pump assembly shall discharge into a distribution manifold fabricated from heavy-duty PVC pipe with metered orifices. A water regulating valve shall be installed in the distribution manifold and will permit field adjustment of water flow over the media. A manual pet-cock metering valve shall be installed in the distribution manifold allowing continuous bleed-off, thus minimizing the build-up of minerals and salts. The Turbocell water system assembly shall be available for 115 or 230 volt single phase operation.

2.4 An adjustable brass float valve shall maintain a constant water level in the Turbocell tank.

2.5 The Turbocell evaporative cooling unit shall have a minimum evaporative efficiency of 88 percent at 700 FPM. Evaporative efficiency is defined as:

$$EE = \frac{T_1 - T_2}{T_1 - T_3} \times 100$$

Where: T1 = Outside air dry bulb temperature, °F.

T2 = Leaving air dry bulb temperature, °F.

T3 = Outside air wet bulb temperature, °F.

MEDIA SPECIFICATIONS		
CONDITION	TURBODEK	FIBERDEK
maximum water temp.	130°F	165°F
maximum air temp.	300°F	300°F
ph range	6-9	5-10
dry weight	2.4 lb/ft ³	4.5 lb/ft ³
wet weight	5.6 lb/ft ³	9.0 lb/ft ³
operating weight	8.0 lb/ft ³	11.4 lb/ft ³
water flow rate (gpm/sq. ft.)	1.5	1.5



Alton[®]

4830 Transport Drive, Dallas, TX 75247

Phone: 214-638-6010

FAX: 214-638-2395



A MESTEK COMPANY

COPYRIGHT FEB. 2004

Sold By:

In the interest of product improvement, Alton reserves the right to make changes without notice.