



Applied Air[®]

AdaptAire

Digital Control System

User Manual

Expert Systems

Table of Contents

<i>OVERVIEW</i>	8
<i>NETWORKING</i>	10
<i>ADAPTAIRE DEFAULT SETTINGS</i>	10
<i>UNIT OPERATING MODES</i>	11
<i>MRT Controls:</i>	11
UNIT OFF MODE.....	11
UNIT MANUAL MODE.....	11
UNIT AUTO MODE.....	12
<i>MDT Controls:</i>	12
UNIT OFF MODE.....	12
UNIT MANUAL MODE.....	12
UNIT AUTO MODE.....	12
<i>MRT-Expert Controls:</i>	12
UNIT OFF MODE.....	12
UNIT MANUAL MODE.....	12
UNIT AUTO MODE.....	13
<i>Scheduling Time Clock</i>	13
<i>Heating Night Setback</i>	16
<i>Cooling Night Setback</i>	16
<i>Auxiliary Unit Enable</i>	16
<i>MDT-Expert Controls:</i>	16
UNIT OFF MODE.....	17
UNIT MANUAL MODE.....	17
UNIT AUTO MODE.....	17
<i>Scheduling Time Clock</i>	17
<i>Auxiliary Unit Enable</i>	20
<i>Heating/Ventilation/Cooling Operating Modes</i>	20
<i>Heating Mode (MRT)</i>	20
Overview.....	20
Room Sensor Failsafe.....	21
Cooldown Period.....	21
Setpoints.....	21
General Burner Control.....	21
Energy Savings Mode 1 Mixing Box Recirculating Units.....	22
Energy Savings Mode 1 Non-Recirculating Units.....	22
Energy Savings Mode 2 Mixing Box Recirculating Direct-Fired Units.....	22
Energy Savings Mode 3.....	22
<i>Recirculating Direct-Fired Heaters</i>	22
<i>Heating Mode (MRT-Expert)</i>	23
Overview.....	23
Room Sensor Failsafe.....	23
Cooldown Period.....	23
Setpoints.....	23
Occupied Mode.....	23
Unoccupied / Night Setback Mode.....	24
General Burner Control.....	24
Energy Savings Mode 1 Mixing Box Recirculating Units.....	24

Energy Savings Mode 1 Non-Recirculating Units.....	24
Energy Savings Mode 2 Mixing Box Recirculating Direct-Fired Units	25
Energy Savings Mode 3	25
<i>Recirculating Direct-Fired Heaters</i>	25
Heating Mode (MDT)	26
Overview	26
Setpoints	26
General Burner Control	26
Energy Savings Mode 2 Mixing Box Recirculating Direct-Fired Units	26
Energy Savings Mode 3	26
<i>Recirculating Direct-Fired Heaters</i>	26
Heating Mode (MDT-Expert)	27
Overview	27
Setpoints	27
Scheduled On Mode	27
Scheduled Off Mode	28
General Burner Control	28
Energy Savings Mode 2 Mixing Box Recirculating Direct-Fired Units	28
Energy Savings Mode 3	28
<i>Recirculating Direct-Fired Heaters</i>	28
Ventilation Mode	29
Cooling Mode (MRT)	32
Overview	32
Room Sensor Failsafe	32
Setpoints	32
General Cooling Control	32
Two Stage Cooling Cycling Sequence	33
Four Stage Cooling Cycling Sequence	33
Energy Savings Mode 4	33
Cooling Mode (MRT-Expert)	33
Overview	33
Room Sensor Failsafe	33
Setpoints	33
Occupied Mode	33
Unoccupied / Night Setback Mode	34
General Cooling Control	34
Two Stage Cooling Cycling Sequence	34
Four Stage Cooling Cycling Sequence	34
Energy Savings Mode 4	35
Cooling Mode (MDT)	35
Overview	35
Setpoints	35
General Cooling Control	35
Two Stage Cooling Cycling Sequence	35
Four Stage Cooling Cycling Sequence	36
Energy Savings Mode 4	36
Cooling Mode (MDT-Expert)	36
Overview	36
Setpoints	36
Scheduled On Mode	36
Scheduled Off Mode	36
General Cooling Control	36
Two Stage Cooling Cycling Sequence	36
Four Stage Cooling Cycling Sequence	37
Energy Savings Mode 4	37

<i>Damper Control Modes</i>	37
Overview	37
Minimum Ventilation.....	38
Manual Mode	38
MRT and MDT Controls.....	38
MRT-Expert and MDT-Expert Controls.....	38
Mixed Air Temperature Mode	39
MDT and MDT-Expert Controls.....	39
MRT Controls.....	39
MRT-Expert Controls.....	39
Building Pressure Mode	39
MRT and MDT Controls.....	40
MRT-Expert and MDT-Expert Controls.....	40
100% Outside Air Mode	40
MRT, MRT-Expert, MDT, and MDT-Expert Controls.....	40
 <i>Freezestat</i>	 40
 <i>Clogged Filter</i>	 41
 <i>Multiplexed Inputs</i>	 42
 <i>Menu Selection Tree for BACview</i>	 43
MODSTAT	44
UNIT MODES HOTKEY - 2	44
SETPOINTS HOTKEY - 3	45
STATUS MENU HOTKEY - 4	45
ALARM HOTKEY - 1	46
RESETS HOTKEY - 6	46
SCHEDULES HOTKEY - 7	46
CLOCKSET HOTKEY - 0	47
HELP HOTKEY - 5	47
USER CONFIGURABLE OUTPUT HOTKEY - 8	48
UNIT SETUP HOTKEY - 9	48
 <i>Protocol Setup</i>	 49
BACnet MS/TP	49
Modbus	50
N2	51
LonWorks	51

<i>Diagnostics – Critical Alarm Codes</i>	53
ALARM CODE: Freezestat	53
SOLUTION: If burner was operating prior to shutdown (check prior alarm log).....	53
SOLUTION: If burner was not operating prior to shutdown (check prior alarm log).....	54
ALARM CODE: Burner Hand	56
SOLUTION: Inspect burner control circuit. <i>This alarm has the potential to be a very serious problem.</i>	
<i>Close the manual gas valves immediately if the fan is not running</i>	56
ALARM CODE: Flame Failure	57
SOLUTION: Investigate flame relay.....	57
 <i>Diagnostics – Non-Critical Alarm Codes</i>	 57
ALARM CODE: Unit Off/Fan On	57
SOLUTION: If fan is running.....	57
SOLUTION: If fan is not running.....	58
ALARM CODE: Unit On/Fan Off	58
SOLUTION: If fan/motor is running.....	58
SOLUTION: If fan/motor is not running.....	58
ALARM CODE: Check Airflow Switches	59
SOLUTION: If high airflow switch is opening. Do not adjust the switch setpoints.....	59
SOLUTION: If low airflow switch is opening. Do not adjust the switch setpoints.....	59
ALARM CODE: Clogged Filters	60
SOLUTION: If clogged filter switch is closing.....	60
ALARM CODE: Safety Circuit Open	61
SOLUTION: If fan is not running (check prior alarm log).....	61
SOLUTION: If fan is running (check prior alarm log).....	61
ALARM CODE: Burner Status Alert	62
SOLUTION: Inspect burner control circuit and burner.....	62
ALARM CODE: Insufficient Outside Air	62
SOLUTION: If heat is desired.....	62
SOLUTION: If less outside air is desired.....	63
ALARM CODE: Room Sensor Failure	64
SOLUTION: Investigate room sensor.....	64
ALARM CODE: Invalid Damper Control Mode	64
SOLUTION: If the unit is configured for MRT or MRT-Expert controls.....	64
SOLUTION: If the unit is configured for MDT or MDT-Expert controls.....	64
ALARM CODE: Monthly/Quarterly/Yearly Maintenance Reminder (See IOM)	65
SOLUTION: If an active maintenance reminder alarm is present:.....	65
 <i>Glossary</i>	 65
 <i>Appendix A</i>	 66
10KΩ Thermistor Output Curve	66
 <i>Appendix B</i>	 67
Airflow Station Layout	67

<i>Appendix C</i>	68
<i>I/O Zone 583 Controller Specifications</i>	68
<i>Appendix D</i>	69
<i>I/O Zone 583 Controller Battery Checkout</i>	69
<i>Appendix E</i>	70
<i>I/O Flex 6126 Controller Specifications</i>	70
<i>Appendix F</i>	71
<i>I/O Flex 6126 Controller Battery Checkout</i>	71
<i>Appendix G</i>	72
<i>Control System Field Conversion</i>	72
<i>Appendix H</i>	74
<i>Room Sensor Wiring</i>	74

OVERVIEW

A glossary has been provided to assist the reader in understanding distinctive terms and phrases. These terms and phrases appear in italics. The terms “unoccupied” and “night setback” are used interchangeably in this manual to refer to all time periods in the unit’s operating schedule outside of the occupied period time range. The terms “supply air” and “discharge air” are used interchangeably in this manual to refer to the conditioned air that leaves the unit through the discharge opening.

Applied Air’s Digital Control System, AdaptAire, is designed to give the user the ultimate in unit performance and operational flexibility, adaptability, and reliability in a user-friendly package. The AdaptAire DDC system is a standard component on Applied Air heating and cooling units. **Because the AdaptAire system encompasses a wide variety of unit types, not all of the system’s capabilities and functions are relevant to all units.** Where a function is similar but different between recirculating and non-recirculating units or direct fired or indirect fired units, the function is explained separately.

AdaptAire accepts single or multiple units on the system network. Each unit can be provided with a *BACview*. The *BACview* connects to the unit control module via the Local Access Port (see Figure 1 for the location of the Local Access Port). The operating parameters for individual units may be input through the *BACview*. A PC may also be connected to the network. This allows the user to configure each unit separately, or all units can be configured simultaneously. A controls contractor can provide assistance in networking.

**Local access port
connection for
BACview.**

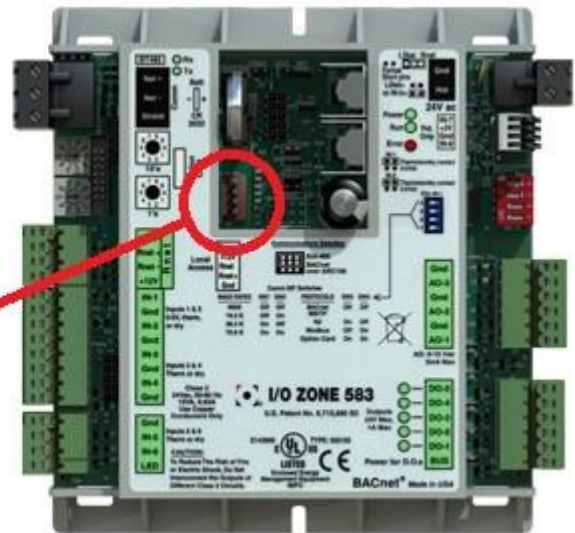

Figure 1

The *BACview* ships with a cable. One end of the cable consists of a pre-wired black screw terminal connector while the other end consists of a 5-pin red-tipped plug.

For MRT and MRT-Expert systems, plug the pre-wired black screw terminal connector into the back of the *BACview* and plug the 5-pin red-tipped plug into the bottom of the room sensor. Because the room sensor is hard-wired to the controller via the Rnet port on the left-hand side of the controller and the *BACview* is connected to the room sensor via

the plug connection on the bottom of the room sensor, this creates a communications link between the *BACview* and the controller without having to directly wire the *BACview* to the controller.

It is easy to move the *BACview* between the location of the room sensor in the space and the unit's location without having to do any additional wiring. Simply unplug the *BACview* from the bottom of the room sensor in the space and take it to where the unit is located. Then, plug the *BACview* into the Local Access Port on the controller as shown in Figure 1. To go from where the unit is located to the room sensor in the space, unplug the *BACview* from the Local Access Port and take it to the room sensor. Then, plug the *BACview* into the bottom of the room sensor.

For MDT and MDT-Expert systems, simply plug the *BACview* into the Local Access Port on the controller as shown in Figure 1 as a room sensor is not provided with these systems.

If there are multiple units at the jobsite, the *BACview* can easily be unplugged from one unit and plugged into another. For this reason, it is not recommended to hardwire the *BACview* into the Rnet port on the left-hand side of the controller because it sacrifices the convenience of portability.

Applied Air's AdaptAire system also includes operational modes such as time scheduling, filter monitoring, and multiple damper control and temperature control schemes. All of these modes provide the maximum in unit operational flexibility.

The optional airflow station imparts unparalleled adaptability into the operation of each unit. A daily self-calibration enables AdaptAire to detect the exact ratio of outside and return air entering the unit. Then AdaptAire daily fine-tunes the unit's operation based on these new parameters. Air volume can vary because of changes in static pressure conditions due to loading filters, VAV boxes, and building dynamics. These varying conditions influence the ventilation air provided by the unit. On certain models of recirculating direct-fired heaters this impacts the allowable *equivalent temperature rise* of the unit that is allowed under the latest ANSI standard for direct-fired heaters.

AdaptAire diagnostic capabilities insure swift response to abnormal unit conditions. An alarm is generated anytime a discrepancy exists between operational parameters and actual unit operation. An alarm indication is displayed at the *BACview* and system PC in text format. In the Diagnostics section of this manual is a list of all alarms and possible causes and solutions.

All of the features of the AdaptAire system are designed to provide the user with real time information. At any time the user can display all of the operational parameters, make changes, if necessary, and observe the various temperature, pressure, and damper readings. The system's diagnostic capabilities provide the user with up to the minute status reporting. (*BACview* remote keypad or *WebCTRL* internet connection is required for these features.)

NETWORKING

AdaptAire is adaptable to a variety of different network architectures and protocols. Each controller has built-in protocol translation and can be configured for operation on ARC156 or EIA-485 communication networks. See Appendix C (I/O Zone 583) or E (I/O Flex 6126) for specific controller specifications.

The AdaptAire system can be connected to most existing building automation systems. Some systems may require the use of special controllers and network communication devices.

ADAPTAIRE DEFAULT SETTINGS

The following is a list of AdaptAire DDC controller defaults. These are the default operating parameters set at the factory prior to shipment.

ITEM	DEFAULT	RANGE
Unit Network Address	varies	000 – 100 rotary switches
Unit Operating Mode	Off	Off – Manual – Auto
Control System	As specified	MRT (modulating room temperature control) – MDT (modulating discharge temperature control)
Use ZS Sensor?	Yes	No - Yes
Time Clock Schedule	None	User Configurable
Damper Operating Mode	As specified	Manual – Building Pressure – Mixed Air Temperature
Fuel Selection	As specified	Natural Gas – Propane
Heating Unoccupied Setpoint	55°F	40°F - 130°F
Cooling Unoccupied Setpoint	100°F	40°F - 130°F
Heating Occupied Setpoint	65°F	40°F - 130°F
Cooling Occupied Setpoint	73°F	40°F - 130°F
Freezestat	45°F	35°F - 80°F
Freezestat Buffer Time	3 minutes	3 - 9 minutes
Heating Economizer Setpoint	65°F	40°F - 130°F
Cooling Economizer Setpoint	55°F	40°F - 130°F
Minimum Heating Discharge Temperature Setpoint	55°F	40°F - 130°F
Maximum Heating Discharge Temperature Setpoint	100°F	40°F - 130°F
Minimum Cooling Discharge Temperature Setpoint	55°F	40°F - 130°F
Maximum Cooling Discharge Temperature Setpoint	75°F	40°F - 130°F
Mixed Air Temperature Setpoint	50°F	30°F - 90°F
Building Pressure Setpoint	0.00" W. C.	-0.05" - +0.05" W. C.
Manual Damper Position Setpoint	20% Outside Air	0% - 100%
Minimum Ventilation Setpoint	20% Outside Air	0% - 100%
Manual Damper Position Setpoint (75/25 direct fired heaters)	25% Outside Air	25% - 100%

ITEM	DEFAULT	RANGE
Minimum Ventilation Setpoint (75/25 direct fired heaters)	25% Outside Air	25% - 100%
Duct Heater Size	As specified	IFD-160 – IFD-320 – IFD-480 - Other
User PID Select	Direct Acting	Direct Acting – Reverse Acting
High Input Value	0.00	-9999.99 – 99999.99
Low Input Value	0.00	-9999.99 – 99999.99
User Control Setpoint	0.00	-9999.99 – 99999.99
Maximum User Setpoint	0.00	-9999.99 – 99999.99
Minimum User Setpoint	0.00	-9999.99 – 99999.99

UNIT OPERATING MODES

There are three different modes that control the supply fan and unit operation:

- Off
- Manual
- Auto

There are also four different methods for controlling the operating modes:

- a *remote control panel* with one or two rotating adjustment knobs (MRT and MDT controls)
- an intelligent room sensor and *BACview* panel with LCD display (MRT-Expert controls)
- an *BACview* panel with LCD display (MDT-Expert controls)
- any of the these controls with an internet-based *WebCTRL* interface or other 3rd party building automation system

MRT Controls:

Modulating room temperature (MRT) control is the most basic AdaptAire control for room temperature. The MRT control system includes a *remote control panel* equipped with 1 or 2 potentiometers, 3 or more pilot lights, and up to 2 switches.

AdaptAire units configured for MRT or MRT-Expert controls will have a fixed discharge temperature of 70°F if the room temperature sensor is disconnected or otherwise fails to communicate with the unit control module.

UNIT OFF MODE

Off Mode is the default unit operational mode. To place the unit in Off Mode, rotate the “temperature setpoint” knob on the *remote control panel* counterclockwise to the stop. This will place the unit in the OFF mode and extinguish the “fan on” light. The OFF mode prevents the unit from starting.

UNIT MANUAL MODE

Manual Mode allows the unit to turn on. To place the unit in Manual Mode, rotate the “temperature setpoint” knob on the *remote control panel* clockwise to the desired room temperature setpoint. This will place the unit in the MANUAL mode and enable the fan and burner. See Heating/Ventilating/Cooling Modes and Energy Saving Modes of this manual for more information.

UNIT AUTO MODE

The MRT control does not support the time clock, night setback, or auxiliary unit enable functions.

MDT Controls:

Modulating discharge temperature (MDT) control is the most basic AdaptAire control for discharge temperature. The MDT control system includes a *remote control panel* equipped with 1 or 2 potentiometers, 3 or more pilot lights, and up to 2 switches.

UNIT OFF MODE

Off Mode is the default unit operational mode. To place the unit in the Off Mode, rotate the “temperature setpoint” knob on the *remote control panel* counterclockwise to the stop. This will place the unit in the OFF mode and extinguish the “fan on” light. The OFF mode prevents the unit from starting.

UNIT MANUAL MODE

Manual Mode allows the unit to turn on. To place the unit in the Manual Mode, rotate the “temperature setpoint” knob on the *remote control panel* clockwise to the desired discharge air temperature setpoint. This will place the unit in the MANUAL mode and enable the fan and burner. See Heating/Ventilating/Cooling Modes and Energy Saving Modes of this manual for more information.

UNIT AUTO MODE

The MDT control does not support the time clock, night setback, or auxiliary unit enable functions.

MRT-Expert Controls:

as AdaptAire MRT-Expert (modulating room temperature) control system provides full information regarding unit operation and allows the user to adjust all operational parameters using the *BACview* panel. See the *Menu Selection Tree for BACview* section of this manual for more information about navigating the *BACview* menus.

AdaptAire units configured for MRT or MRT-Expert controls will have a fixed discharge temperature of 70°F if the room temperature sensor is disconnected or otherwise fails to communicate with the unit control module.

UNIT OFF MODE

Off Mode is the default unit operational mode. To place the unit in Off Mode, scroll through the Unit Modes menu tree, locate the AUTO/OFF/MANUAL branch, and select OFF. This will place the unit in the OFF mode. The OFF mode prevents the fan and burner from starting. This mode will override the Time Clock and Night Setback functions.

UNIT MANUAL MODE

Manual Mode allows the supply fan to turn on regardless of the Time Clock or Night Setback functions. *Heating and cooling functions use the Occupied Setpoints.* To place the unit in Manual Mode, scroll through the Unit Modes menu tree, locate the

AUTO/OFF/MANUAL branch, and select MANUAL. This will place the unit in the MANUAL mode.

UNIT AUTO MODE

Auto Mode has four different functions that control the supply fan and unit operation. They are a time clock function, heating and cooling night setbacks, and a signal from an external source to an auxiliary digital input. To place the unit in Auto Mode, scroll through the Unit Modes menu tree, locate the AUTO/OFF/MAN branch, and select AUTO. This will place the unit in the AUTO mode. This activates the four Auto mode functions.

Scheduling Time Clock

The primary Auto Mode function is the Time Clock Schedule. The Time Clock function allows the user to schedule the unit's occupied and unoccupied periods. There are four different schedules available: 24 hour continuous operation, daily, holiday, and override. The daily schedule can be programmed for up to 4 separate On/Off events with any combination of days. The daily schedule sets the typical Occupied/Unoccupied times for the unit. The holiday schedule can be programmed for up to 12 separate Occupied/Unoccupied events with any combination of days. The holiday schedule sets the Unoccupied times for holidays and other shutdown periods. The override schedule can be programmed for up to 2 separate Occupied/Unoccupied events with any combination of days. The override schedule sets the Occupied times that will override the holiday schedule. This scheduling system allows the user to program a diverse array of Occupied/Unoccupied operations. The AdaptAire DDC system has no preset Occupied/Unoccupied schedule.

To set the Occupied/Unoccupied times of the unit scroll through the SCHEDULES menu tree, and locate the desired Daily, Holiday, or Override branch. Enter the days and times for the unit to run in Occupied mode. In the Daily or Override section these times should correspond to the desired Occupied times for the unit's operation. In the Holiday section these times should correspond to the desired Unoccupied times for the unit's operation.

For any schedule to function the Use tab must be set to yes.

To set the time clock function for **24 hour continuous operation**, scroll through the menu tree and locate the SCHEDULES page. Set the 24 Hr Operation to yes. Enter the Daily section of the menu and set the Use tab to yes. Finally select the days for 24 hour operation. The unit uses the Occupied setpoints in 24 hour continuous operation mode.

See the CLOCK SET section of this manual for setting the time, date and Daylight Savings function.

The following instructions demonstrate how to set up a sample schedule using the *BACview* remote. An example of a typical schedule would be to have the unit Occupied Monday through Friday from 6:00 AM to 5:00 PM, except during the week of Thanksgiving when the units will be Unoccupied. However they will be Occupied each weekday during Thanksgiving week from 8:00 AM until noon while a maintenance crew is in the building. The maintenance crew will come in at 5:00 AM on Friday to complete preliminary tasks in preparation for the week. We will use this sample schedule as our guide in programming the sample schedule. Refer to the Menu Selection Tree for

BACview section of this manual for more information about the *BACview* buttons, hotkeys, and menus.

The sample schedule and instructions below are just a guide; you may skip the rest of the Scheduling Time Clock section of this manual if you are already comfortable programming daily, holiday, and override schedules. Simply determine when you want the unit to operate on the Occupied and Unoccupied setpoints and set the schedule in the *BACview* accordingly.

1. Use the **FN + 7** hotkey to jump directly to the Schedules screen of the menu tree. While holding the **FN** key, press the **7** key, and the Schedules screen will appear. The *BACview* may prompt you for the User password. The default password is 0000.

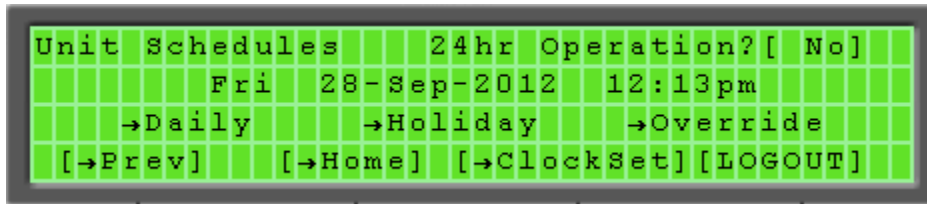

2. Navigate to the **Daily** field and press the **Enter** button. The screen will show a blank daily schedule.

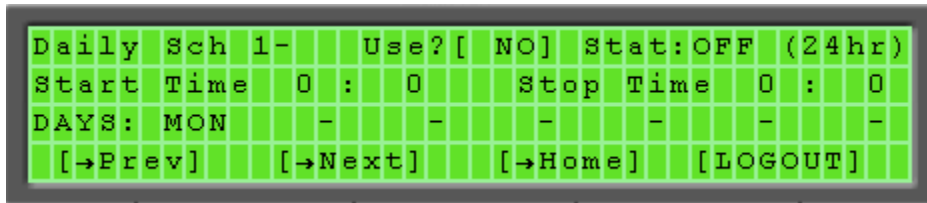

3. To enable the **Daily** schedule, set the **Use** field to **Yes**. The **Stat** field indicates whether the schedule on that screen is currently active, so you may see either **ON** or **OFF** in this field. Navigate to the **Start Time** field and set the start time for **6:00 AM**. Be aware that times are programmed in a 24 hour format. For example, **2:00 PM** would be programmed as **14:00**, which will show up on the *BACview* screen as “**14 : 0**”.
4. Navigate to the **Stop Time** field and set the stop time for **5:00 PM (17:00** in the 24 hour format).
5. Navigate to the **Days** fields, making sure the cursor surrounds the first hyphen ([-]). Press the **Enter** button and then press the link key that corresponds to **INCR** on the screen. The field will now show **MON**, indicating that this schedule will be active every Monday from 6:00 AM to 5:00 PM. Repeat this process for each of the remaining **Days** fields, except for **SAT** and **SUN**. Your screen should now look like this:

```

Daily Sch 1- Use? YES Stat: ON (24hr)
Start Time 6 : 0 Stop Time 17 : 0
DAYS: MON TUE WED THU [FRI] - -
[→Prev] [→Next] [→Home] [LOGOUT]

```

- The week of Thanksgiving for 2012 is from Sunday, November 18th to Saturday, November 24th. We want the unit to operate in Occupied mode each weekday from 8:00 AM to 12:00 PM while the maintenance crew is in the building during that week. We will need to set up a few Holiday schedules to accomplish this. Since the unit normally runs in the Occupied mode from 6:00 AM to 5:00 PM on weekdays, we need to set the Unoccupied periods in the Holiday schedules. The Unoccupied period we want to schedule then is from 6:00 AM to 8:00 AM and 12:00 PM to 5:00 PM. We will use 10 Holiday schedules to accomplish this (two for each weekday).
- Navigate back to the Schedules screen using the **FN + 7** hotkey. Move the cursor to select the **Holiday** field and press Enter. Set the start time to **6:00 AM** and the stop time to **8:00 AM**. Remember, the Holiday schedules represent the period during which the unit is to be Unoccupied. Set the **Month** field to **11** (November) and the **Day** field to **19** (Monday, the first weekday that week). Your screen should now look like this:

```

Holiday Sch 1- Use? YES Stat: ON (24hr)
Start Time 6 : 0 Stop Time 8 : 0
Month: 11 (1-12) Day: [19] (1-31)
[→Prev] [→Next] [→Home] [LOGOUT]

```

- Press the link key corresponding to the **Next** field on the screen. This will take you to Holiday Schedule 2. Set the start time for Holiday Schedule 2 to **12:00 PM** and the stop time to **5:00 PM**. Set the **Month** field to **11** (November) and the **Day** field to **19** (Monday, the first weekday that week). Your screen should now look like this:

```

Holiday Sch 2- Use? YES Stat: OFF (24hr)
Start Time 12 : 0 Stop Time 17 : 0
Month: 11 (1-12) Day: [19] (1-31)
[→Prev] [→Next] [→Home] [LOGOUT]

```

Repeat this step for the 20th, 21st, 22nd, and 23rd (Tuesday, Wednesday, Thursday, and Friday) using Holiday Schedules 3 through 10, then proceed to the next step.

- Since the maintenance crew will be in the building at 5:00 AM on Monday, we will need an override schedule to override part of the Holiday schedule we just created. Navigate back to the Schedules screen using the **FN + 7** hotkey. Move the cursor to select the **Override** field and press Enter. Set the start time to 5:00 AM and the stop time to 8:00 AM. Remember, the Override schedules override

the Holiday schedules and represent the period during which the unit is to be Occupied. Set the **Month** field to **11** (November) and the **Day** field to **19** (Monday, the first weekday of Thanksgiving week in 2012). Your screen should now look like this:

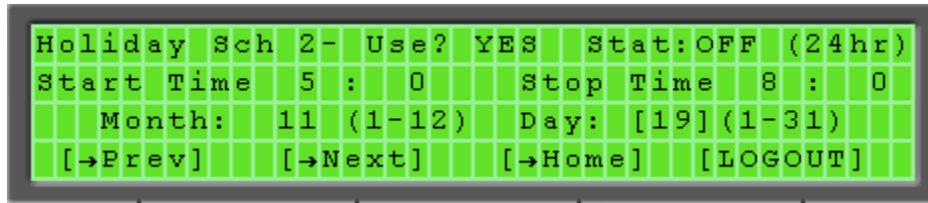

10. Press the link key corresponding to the **Home** field on the screen to return to the Home screen. The sample schedule is programmed and the units will automatically switch between Occupied and Unoccupied modes based on the daily, holiday, and override schedules.

Heating Night Setback

The Heating Night Setback function automatically cycles the unit “on” if the room temperature falls below the Heating Setback temperature setpoint, and the unit is scheduled to be “off”. If the unit is scheduled to be “off” and the Heating Setback function turns the unit “on”, the unit will be cycled “off” once the room air temperature has risen 2° above the Heating Setback setpoint. The default for this setpoint is 55°F. To change the Heating Setback setpoint scroll through the SETPOINTS menu tree, locate the Heating Setback setpoint and enter a new temperature. The allowable temperature range is 40°F - 130°F.

Cooling Night Setback

The Cooling Night Setback function automatically cycles the unit “on” if the room temperature rises above the Cooling Setback temperature setpoint and the unit is scheduled to be “off”. If the unit is scheduled to be “off” and the Cooling Setback function turns the unit “on”, the unit will be cycled off once the room air temperature has fallen 2° below the Cooling Setback setpoint. This function toggles digital output DO1. The default for this setpoint is 100°F. To change the Cooling Setback setpoint scroll through the SETPOINTS menu tree, locate the Cooling Setback setpoint and enter a new temperature. The allowable temperature range is 40°F - 130°F.

Auxiliary Unit Enable

The Auxiliary Unit Enable function overrides all other Auto Mode functions and automatically cycles the unit into operation. This function is activated whenever a contact is closed between the appropriate terminals on the unit’s terminal strip located in the unit’s main control panel. *Heating and cooling functions use the Night Setback Setpoints.* See the Typical Wiring Schematic and Multiplexed Input sections of this manual for more information. This function can be used with a twist timer, toggle switch, door switch, exhaust fan interlock, or any other dry contact to override the time clock schedule.

MDT-Expert Controls:

The AdaptAire MDT-Expert (modulating discharge temperature) control system provides full information regarding unit operation and allows the user to adjust all operational

parameters using the *BACview* panel. See the *Menu Selection Tree for BACview* section of this manual for more information about navigating the *BACview* menus.

UNIT OFF MODE

Off Mode is the default unit operational mode. To place the unit in Off Mode scroll through the Unit Modes menu tree, locate the AUTO/OFF/MANUAL branch, and select OFF. This will place the unit in the OFF mode. The OFF mode prevents the fan and burner from starting. This mode will override the Time Clock function.

UNIT MANUAL MODE

Manual Mode allows the supply fan to turn on regardless of the Time Clock function. To place the unit in Manual Mode scroll through the Unit Modes menu tree, locate the AUTO/OFF/MANUAL branch, and select MANUAL. This will place the unit in the MANUAL mode.

UNIT AUTO MODE

Auto Mode has two different functions that control the supply fan and unit operation. They are a time clock function and a signal from an external source to an auxiliary digital input. To place the unit in Auto Mode scroll through the Unit Modes menu tree, locate the AUTO/OFF/MAN branch, and select AUTO. This will place the unit in the AUTO mode. This activates the four Auto mode functions.

Scheduling Time Clock

The MDT-EXPERT control does not support the night setback functions.

The primary Auto Mode function is the Time Clock Schedule. The Time Clock function allows the user to schedule the operational times of the unit. There are four different schedules available: 24 hour continuous operation, daily, holiday, and override. The daily schedule can be programmed for up to 4 separate On/Off events with any combination of days. The daily schedule sets the typical operational times for the unit. The holiday schedule can be programmed for up to 12 separate On/Off events with any combination of days. The holiday schedule sets the Off times for holidays and other shutdown periods. The override schedule can be programmed for up to 2 separate On/Off events with any combination of days. The override schedule sets the On times that will override the holiday schedule. This scheduling system allows the user to program a diverse array of On/Off operations. The AdaptAire DDC system has no preset On/Off schedule.

To set the On/Off times of the unit scroll through the SCHEDULES menu tree, and locate the desired Daily, Holiday, or Override branch. Enter the days and times based on the desired schedule. In the Daily or Override section these times should correspond to the desired On times for the unit's operation. In the Holiday section these times should correspond to the desired Off times for the unit's operation. **For any schedule to function the Use tab must be set to yes.**

To set the time clock function for **24 hour continuous operation**, scroll through the menu tree and locate the SCHEDULES page. Set the 24 Hr Operation to yes. Enter the Daily section of the menu and set the Use tab to yes. Finally select the days for 24 hour operation.

See the CLOCK SET section of this manual for setting the time, date and Daylight Savings function.

The following instructions demonstrate how to set up a sample schedule using the *BACview* remote. An example of a typical schedule would be to have the unit On Monday through Friday from 6:00 AM to 5:00 PM, except during the week of Thanksgiving when the units will be Off. However they will be On each weekday during Thanksgiving week from 8:00 AM until noon while a maintenance crew is in the building. The maintenance crew will come in at 5:00 AM on Friday to complete preliminary tasks in preparation for the week. We will use this sample schedule as our guide in programming the sample schedule. Refer to the Menu Selection Tree for *BACview* section of this manual for more information about the *BACview* buttons, hotkeys, and menus.

The sample schedule and instructions below are just a guide; you may skip the rest of the Scheduling Time Clock section of this manual if you are already comfortable programming daily, holiday, and override schedules. Simply determine when you want the unit to operate on the Occupied and Unoccupied setpoints and set the schedule in the *BACview* accordingly.

1. Use the **FN + 7** hotkey to jump directly to the Schedules screen of the menu tree. While holding the **FN** key, press the **7** key, and the Schedules screen will appear. The *BACview* may prompt you for the User password. The default password is 0000.

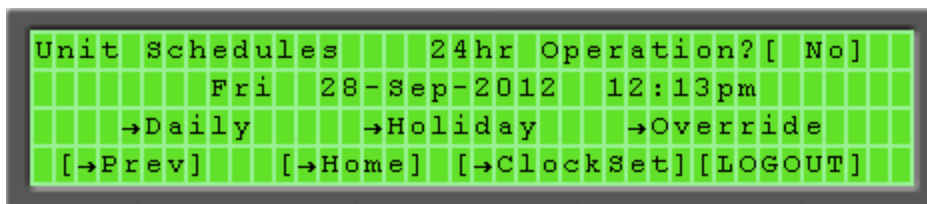

2. Navigate to the **Daily** field and press the **Enter** button. The screen will show a blank daily schedule.

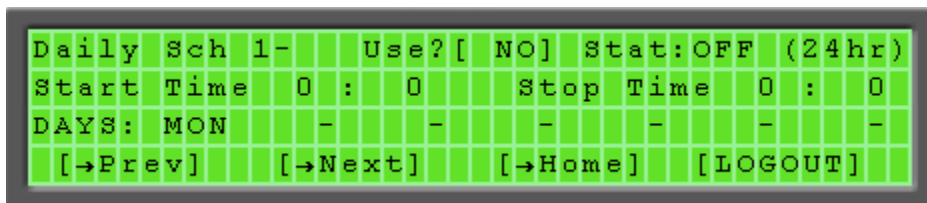

3. To enable the **Daily** schedule, set the **Use** field to **Yes**. The **Stat** field indicates whether the schedule on that screen is currently active, so you may see either **ON** or **OFF** in this field. Navigate to the **Start Time** field and set the start time for **6:00 AM**. Be aware that times are programmed in a 24 hour format. For example, **2:00 PM** would be programmed as **14:00**, which will show up on the *BACview* screen as "**14 : 0**".

- Navigate to the **Stop Time** field and set the stop time for **5:00 PM (17:00)** in the 24 hour format).
- Navigate to the **Days** fields, making sure the cursor surrounds the first hyphen ([-]). Press the **Enter** button and then press the link key that corresponds to **INCR** on the screen. The field will now show **MON**, indicating that this schedule will be active every Monday from 6:00 AM to 5:00 PM. Repeat this process for each of the remaining **Days** fields, except for **SAT** and **SUN**. Your screen should now look like this:

```

Daily Sch 1- Use? YES Stat: ON (24hr)
Start Time 6 : 0 Stop Time 17 : 0
DAYS: MON TUE WED THU [FRI] - -
[→Prev] [→Next] [→Home] [LOGOUT]

```

- The week of Thanksgiving for 2012 is from Sunday, November 18th to Saturday, November 24th. We want the unit to be On each weekday from 8:00 AM to 12:00 PM while the maintenance crew is in the building during that week. We will need to set up a few Holiday schedules to accomplish this. Since the unit is normally On from 6:00 AM to 5:00 PM on weekdays, we need to set the Off periods in the Holiday schedules. The Off period we want to schedule then is from 6:00 AM to 8:00 AM and 12:00 PM to 5:00 PM. We will use 10 Holiday schedules to accomplish this (two for each weekday).
- Navigate back to the Schedules screen using the **FN + 7** hotkey. Move the cursor to select the **Holiday** field and press Enter. Set the start time to **6:00 AM** and the stop time to **8:00 AM**. Remember, the Holiday schedules represent the period during which the unit is to be Off. Set the **Month** field to **11** (November) and the **Day** field to **19** (Monday, the first weekday that week). Your screen should now look like this:

```

Holiday Sch 1- Use? YES Stat: ON (24hr)
Start Time 6 : 0 Stop Time 8 : 0
Month: 11 (1-12) Day: [19] (1-31)
[→Prev] [→Next] [→Home] [LOGOUT]

```

- Press the link key corresponding to the **Next** field on the screen. This will take you to Holiday Schedule 2. Set the start time for Holiday Schedule 2 to **12:00 PM** and the stop time to **5:00 PM**. Set the **Month** field to **11** (November) and the **Day** field to **19** (Monday, the first weekday that week). Your screen should now look like this:

```

Holiday Sch 2- Use? YES Stat: OFF (24hr)
Start Time 12 : 0 Stop Time 17 : 0
Month: 11 (1-12) Day: [19] (1-31)
[→Prev] [→Next] [→Home] [LOGOUT]

```

Repeat this step for the 20th, 21st, 22nd, and 23rd (Tuesday, Wednesday, Thursday, and Friday) using Holiday Schedules 3 through 10, then proceed to the next step.

9. Since the maintenance crew will be in the building at 5:00 AM on Monday, we will need an override schedule to override part of the Holiday schedule we just created. Navigate back to the Schedules screen using the **FN + 7** hotkey. Move the cursor to select the **Override** field and press Enter. Set the start time to 5:00 AM and the stop time to 8:00 AM. Remember, the Override schedules override the Holiday schedules and represent the period during which the unit is to be On. Set the **Month** field to **11** (November) and the **Day** field to **19** (Monday, the first weekday of Thanksgiving week in 2012). Your screen should now look like this:

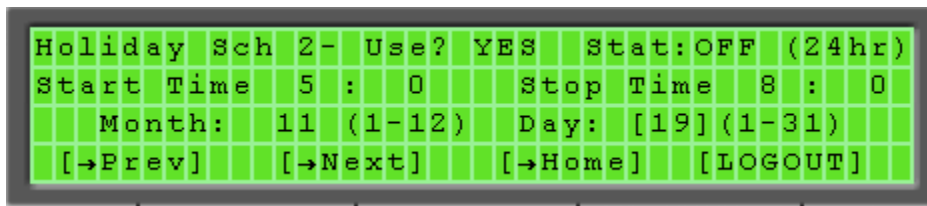

10. Press the link key corresponding to the **Home** field on the screen to return to the Home screen. The sample schedule is programmed and the units will automatically switch between On and Off modes based on the daily, holiday, and override schedules.

Auxiliary Unit Enable

The Auxiliary Unit Enable function overrides the time clock function and automatically cycles the unit into operation. This function is activated whenever a contact is closed between the appropriate terminals on the unit's terminal strip located in the unit's main control panel. See the Typical Wiring Schematic and Multiplexed Input sections of this manual for more information. This function can be used with a twist timer, toggle switch, door switch, exhaust fan interlock, or any other dry contact to override the time clock schedule.

Heating/Ventilation/Cooling Operating Modes

The AdaptAire DDC controller automatically switches between the heating, ventilating and cooling modes of operation. The previous sections described the Heating and Cooling Setback operation.

Heating Mode (MRT)

Overview

In the Heating Mode of the MRT control system, the burner will modulate to maintain a constant room temperature and maintain the supply air temperature between the minimum and maximum heating discharge air temperature setpoints. A call for unit enable and a fan status signal must be present for the burner to turn on.

In order of lowest to greatest priority, the burner modulation parameters are maximum heating discharge air temperature, room temperature, minimum heating discharge air temperature, and equivalent temperature rise.

The burner is **enabled** if the outside air temperature is below the minimum heating discharge temperature setpoint or the room temperature is more than 2°F below the heating occupied setpoint.

The burner is **disabled** if the outside air temperature is more than 2°F above the minimum heating discharge air temperature setpoint and the room temperature is above the heating occupied setpoint, if an Energy Savings Mode is active, or if the Burner Hand alarm is active.

The burner is **disabled** if the unit enable potentiometer on the *remote control panel* is set to the Off position (turned all the way counter-clockwise).

Room Sensor Failsafe

AdaptAire units configured for MRT control will have a fixed discharge temperature of 70°F if the room temperature sensor is disconnected or otherwise fails to communicate with the unit control module.

Cooldown Period

For indirect fired units and electric heating units only, the fan will run for 3 minutes any time the burner or heater cycles on during the unoccupied period or if the burner or heater was running at the end of the occupied period to remove excess heat from the heat exchanger or heating coil.

Setpoints

To change the desired room temperature setpoint, rotate the temperature setpoint knob on the *remote control panel* clockwise to the desired temperature. The allowable temperature range is 55°F - 90°F.

General Burner Control

If the burner is enabled and the room setpoint is not yet satisfied, the unit will maintain the supply air temperature at the maximum heating discharge air temperature setpoint. As the room temperature begins to rise, the unit will begin to limit the analog voltage output to the gas valve. This may limit the supply air temperature to prevent overheating the space.

Once the room temperature is satisfied, the analog voltage output limit may be overridden to allow the unit to maintain the supply air temperature above the minimum heating discharge air temperature setpoint if the outside air temperature is below the minimum heating discharge air temperature setpoint.

If the minimum and maximum discharge air temperature setpoints are set for the same temperature, the supply air temperature will be the same as the setpoint regardless of the room temperature setpoint or actual room temperature.

Energy Savings Mode 1 Mixing Box Recirculating Units

Energy Savings Mode 1 will automatically disable the burner if the mixed air temperature is equal to or greater than the minimum discharge air temperature setpoint, and the room air temperature is 5°F above the room air temperature setpoint. This function is intended to restrain the room temperature from rising uncontrollably in buildings with internal heat gain. The burner will remain disabled until the mixed air temperature falls 2°F below the mixed air temperature setpoint and the room temperature falls 2°F below the heating setpoint. In certain conditions it may be necessary to readjust the minimum discharge air or room temperature setpoint upward or adjust the outside/return air ratio to provide a warmer supply air temperature.

Energy Savings Mode 1 Non-Recirculating Units

Energy Savings Mode 1 will automatically disable the burner if the outside air temperature is equal to or greater than the minimum discharge air temperature setpoint, and the room air temperature is 5°F above the room air temperature setpoint. This function is intended to restrain the room temperature from rising uncontrollably in buildings with internal heat gain. The burner will remain disabled until the outside air temperature falls 2°F below the minimum discharge air temperature setpoint and the room temperature falls 2°F below the heating setpoint. In certain conditions it may be necessary to readjust the minimum discharge air or room temperature setpoint upward to provide a warmer supply air temperature.

Energy Savings Mode 2 Mixing Box Recirculating Direct-Fired Units

Energy Savings Mode 2 will automatically disable the burner if the burner's minimum firing rate exceeds the maximum allowable equivalent temperature rise. This condition is unlikely to occur unless the burner's minimum firing rate is misadjusted and set too high, or the inlet air opening is restricted.

Energy Savings Mode 3

Energy Savings Mode 3 will automatically disable the burner if the outside air temperature is above the Heating Economizer setpoint. This function is similar to an inlet duct thermostat. The burner will cycle back on if the supply air temperature drops 3°F below the Heating Economizer setpoint.

Recirculating Direct-Fired Heaters

Using different controller software, the AdaptAire DDC system can accommodate three distinct types of recirculating direct-fired units: those that return air before the burner and employ a special airflow station, those that return air before the burner and do not employ a special airflow station, and those that recirculate air after the burner. Recirculating direct-fired units, like all direct-fired units, deliver all of their products of combustion directly to the heated air space. For this reason it is extremely important that the proper ventilation rate be maintained to dilute these emissions.

AdaptAire units, that recirculate air before the burner and employ an airflow measuring station, utilize a control scheme that measures air pressure to determine the ratio of outside air and return air. These units **are listed** by an independent third party testing agency and use the *equivalent temperature rise* control scheme to limit burner modulation. The AdaptAire system accurately measures the ratio of outside and return air, calculates the allowable *equivalent temperature rise* and automatically limits the burners firing rate. This insures the products of combustion, delivered to the space by the

unit, are held at or below allowable OSHA thresholds. The outside air percentage is the driving parameter for this function. A greater percentage of outside air or dilution air enables the unit to generate a higher allowable equivalent temperature rise. The maximum allowable *equivalent temperature rise* for 20% outside air is 48.9°F. The maximum allowable *equivalent temperature rise* increases 1.22°F for each 1% increase in outside air.

AdaptAire units, that recirculate air before the burner and do not employ an airflow measuring station, utilize a control scheme that measures damper position to determine the percentage of return air. These units **are not listed** by an independent third party testing agency but do use the *equivalent temperature rise* control scheme to limit burner modulation. The maximum allowable *equivalent temperature rise* for 20% outside air is 48.9°F. The maximum allowable *equivalent temperature rise* increases 1.22°F for each 1% increase in outside air.

AdaptAire units that recirculate air after the burner are physically constrained to limit the percentage of return air. These constraints are meant to provide the proper dilution air. These units **are not listed** by an independent third party testing agency and do not use the equivalent temperature rise control scheme to limit burner modulation.

Heating Mode (MRT-Expert)

Overview

In the Heating Mode of the MRT-Expert control system, the burner will modulate to maintain a constant room temperature and maintain the supply air temperature between the minimum and maximum heating discharge air temperature setpoints. A call for unit enable and a fan status signal must be present for the burner to turn on.

In order of lowest to greatest priority, the burner modulation parameters are maximum heating discharge air temperature, room temperature, minimum heating discharge air temperature, and equivalent temperature rise.

Room Sensor Failsafe

AdaptAire units configured for MRT-Expert controls will have a fixed discharge temperature of 70°F if the room temperature sensor is disconnected or otherwise fails to communicate with the unit control module. When the room sensor fails to communicate with the controller, a room temperature of 0°F will display on the *BACview*.

Cooldown Period

For indirect fired units and electric heating units only, the fan will run for 3 minutes any time the burner or heater cycles on during the unoccupied period or if the burner or heater was running at the end of the occupied period to remove excess heat from the heat exchanger or heating coil.

Setpoints

Navigate to Unit Setpoints on the *BACview* to change heating setpoints.

Occupied Mode

The burner is **enabled** if the outside air temperature is below the minimum heating discharge temperature setpoint or the room temperature is more than 2°F below the heating occupied setpoint.

The burner is **disabled** if the outside air temperature is more than 2°F above the minimum heating discharge air temperature setpoint and the room temperature is above the heating occupied setpoint, if an Energy Savings Mode is active, or if the Burner Hand alarm is active.

Unoccupied / Night Setback Mode

The burner is **enabled** if the room temperature is below the heating night setback setpoint.

The burner is **disabled** if the room temperature is 2°F above the heating night setback setpoint, if an Energy Savings Mode is active, or if the Burner Hand alarm is active.

General Burner Control

If the burner is enabled and the room setpoint is not yet satisfied, the unit will maintain the supply air temperature at the maximum heating discharge air temperature setpoint. As the room temperature begins to rise, the unit will begin to limit the analog voltage output to the gas valve. This may limit the supply air temperature to prevent overheating the space.

Once the room temperature is satisfied, the analog voltage output limit may be overridden to allow the unit to maintain the supply air temperature above the minimum heating discharge air temperature setpoint if the outside air temperature is below the minimum heating discharge air temperature setpoint.

If the minimum and maximum discharge air temperature setpoints are set for the same temperature, the supply air temperature will be the same as the setpoint regardless of the room temperature setpoint or actual room temperature.

Energy Savings Mode 1 Mixing Box Recirculating Units

Energy Savings Mode 1 will automatically disable the burner if the mixed air temperature is equal to or greater than the minimum discharge air temperature setpoint, and the room air temperature is 5°F above the room air temperature setpoint. This function is intended to restrain the room temperature from rising uncontrollably in buildings with internal heat gain. The burner will remain disabled until the mixed air temperature falls 2°F below the mixed air temperature setpoint and the room temperature falls 2°F below the heating setpoint. In certain conditions it may be necessary to readjust the minimum discharge air or room temperature setpoint upward or adjust the outside/return air ratio to provide a warmer supply air temperature.

Energy Savings Mode 1 Non-Recirculating Units

Energy Savings Mode 1 will automatically disable the burner if the outside air temperature is equal to or greater than the minimum discharge air temperature setpoint, and the room air temperature is 5°F above the room air temperature setpoint. This function is intended to restrain the room temperature from rising uncontrollably in buildings with internal heat gain. The burner will remain disabled until the outside air temperature falls 2°F below the minimum discharge air temperature setpoint and the room temperature falls 2°F below the heating setpoint. In certain conditions it may be necessary to readjust the minimum discharge air or room temperature setpoint upward to provide a warmer supply air temperature.

Energy Savings Mode 2 Mixing Box Recirculating Direct-Fired Units

Energy Savings Mode 2 will automatically disable the burner if the burner's minimum firing rate exceeds the maximum allowable equivalent temperature rise. This condition is unlikely to occur unless the burner's minimum firing rate is misadjusted and set too high, or the inlet air opening is restricted.

Energy Savings Mode 3

Energy Savings Mode 3 will automatically disable the burner if the outside air temperature is above the Heating Economizer setpoint. This function is similar to an inlet duct thermostat. The burner will cycle back on if the supply air temperature drops 3°F below the Heating Economizer setpoint.

Recirculating Direct-Fired Heaters

Using different controller software, the AdaptAire DDC system can accommodate three distinct types of recirculating direct-fired units: those that return air before the burner and employ a special airflow station, those that return air before the burner and do not employ a special airflow station, and those that recirculate air after the burner. Recirculating direct-fired units, like all direct-fired units, deliver all of their products of combustion directly to the heated air space. For this reason it is extremely important that the proper ventilation rate be maintained to dilute these emissions.

AdaptAire units, that recirculate air before the burner and employ an airflow measuring station, utilize a control scheme that measures air pressure to determine the ratio of outside air and return air. These units **are listed** by an independent third party testing agency and use the *equivalent temperature rise* control scheme to limit burner modulation. The AdaptAire system accurately measures the ratio of outside and return air, calculates the allowable *equivalent temperature rise* and automatically limits the burners firing rate. This insures the products of combustion, delivered to the space by the unit, are held at or below allowable OSHA thresholds. The outside air percentage is the driving parameter for this function. A greater percentage of outside air or dilution air enables the unit to generate a higher allowable equivalent temperature rise. The maximum allowable *equivalent temperature rise* for 20% outside air is 48.9°F. The maximum allowable *equivalent temperature rise* increases 1.22°F for each 1% increase in outside air.

AdaptAire units, that recirculate air before the burner and do not employ an airflow measuring station, utilize a control scheme that measures damper position to determine the percentage of return air. These units **are not listed** by an independent third party testing agency but do use the *equivalent temperature rise* control scheme to limit burner modulation. The maximum allowable *equivalent temperature rise* for 20% outside air is 48.9°F. The maximum allowable *equivalent temperature rise* increases 1.22°F for each 1% increase in outside air.

AdaptAire units that recirculate air after the burner are physically constrained to limit the percentage of return air. These constraints are meant to provide the proper dilution air. These units **are not listed** by an independent third party testing agency and do not use the equivalent temperature rise control scheme to limit burner modulation.

Heating Mode (MDT)

Overview

In the Heating Mode of the MDT control system, the burner will modulate to maintain a constant supply air temperature. A call for unit enable and a fan status signal must be present for the burner to turn on.

In order of lowest to greatest priority, the burner modulation parameters are supply air temperature and equivalent temperature rise.

The burner is **enabled** if the outside air temperature is more than 2°F below the heating/cooling changeover setpoint.

The burner is **disabled** if the outside air temperature is above the heating/cooling changeover setpoint.

The burner is **disabled** if the unit enable potentiometer on the *remote control panel* is set to the Off position (turned all the way counter-clockwise).

Setpoints

To change the desired heating discharge temperature setpoint of an MDT control system, rotate the temperature setpoint knob on the *remote control panel* clockwise to the desired temperature. The allowable temperature range is 55°F - 90°F.

General Burner Control

If the burner is enabled, the unit will maintain the supply air temperature at the discharge air temperature setpoint.

Energy Savings Mode 2 – Mixing Box Recirculating Direct-Fired Units

Energy Savings Mode 2 will automatically disable the burner if the burner's minimum firing rate exceeds the maximum allowable equivalent temperature rise. This condition is unlikely to occur unless the burner's minimum firing rate is misadjusted and set too high, or the inlet air opening is restricted.

Energy Savings Mode 3

Energy Savings Mode 3 will automatically disable the burner if the outside air temperature is above the Heating Economizer setpoint. This function is similar to an inlet duct thermostat. The burner will cycle back on if the supply air temperature drops 3°F below the Heating Economizer setpoint.

Recirculating Direct-Fired Heaters

Using different controller software, the AdaptAire DDC system can accommodate three distinct types of recirculating direct-fired units: those that return air before the burner and employ a special airflow station, those that return air before the burner and do not employ a special airflow station, and those that recirculate air after the burner. Recirculating direct-fired units, like all direct-fired units, deliver all of their products of combustion directly to the heated air space. For this reason it is extremely important that the proper ventilation rate be maintained to dilute these emissions.

AdaptAire units, that recirculate air before the burner and employ an airflow measuring station, utilize a control scheme that measures air pressure to determine the ratio of

outside air and return air. These units **are listed** by an independent third party testing agency and use the *equivalent temperature rise* control scheme to limit burner modulation. The AdaptAire system accurately measures the ratio of outside and return air, calculates the allowable *equivalent temperature rise* and automatically limits the burners firing rate. This insures the products of combustion, delivered to the space by the unit, are held at or below allowable OSHA thresholds. The outside air percentage is the driving parameter for this function. A greater percentage of outside air or dilution air enables the unit to generate a higher allowable equivalent temperature rise. The maximum allowable *equivalent temperature rise* for 20% outside air is 48.9°F. The maximum allowable *equivalent temperature rise* increases 1.22°F for each 1% increase in outside air.

AdaptAire units, that recirculate air before the burner and do not employ an airflow measuring station, utilize a control scheme that measures damper position to determine the percentage of return air. These units **are not listed** by an independent third party testing agency but do use the *equivalent temperature rise* control scheme to limit burner modulation. The maximum allowable *equivalent temperature rise* for 20% outside air is 48.9°F. The maximum allowable *equivalent temperature rise* increases 1.22°F for each 1% increase in outside air.

For AdaptAire units that recirculate air before the burner and use the MDT control, the maximum burner firing rate is limited by the discharge setpoint or the maximum allowable *equivalent temperature rise*, whichever is less.

AdaptAire units that recirculate air after the burner are physically constrained to limit the percentage of return air. These constraints are meant to provide the proper dilution air. These units **are not listed** by an independent third party testing agency and do not use the equivalent temperature rise control scheme to limit burner modulation.

Heating Mode (MDT-Expert)

Overview

In the Heating Mode of the MDT-Expert control system, the burner will modulate to maintain a constant supply air temperature. A call for unit enable and a fan status signal must be present for the burner to turn on.

In order of lowest to greatest priority, the burner modulation parameters are supply air temperature and equivalent temperature rise.

Setpoints

Navigate to Unit Setpoints on the *BACview* to change setpoints.

Scheduled On Mode

Scheduled On mode refers to any time the unit is running based on an ON schedule.

The burner is **enabled** if the outside air temperature is more than 2°F below the heating/cooling changeover setpoint in Scheduled On mode.

The burner is **disabled** if the outside air temperature is above the heating/cooling changeover setpoint in Scheduled On mode.

Scheduled Off Mode

Scheduled Off mode refers to any time the unit is outside of the time ranges of any ON schedules. The burner is **disabled** in Scheduled Off mode.

General Burner Control

If the burner is enabled, the unit will maintain the supply air temperature at the discharge air temperature setpoint.

Energy Savings Mode 2 – Mixing Box Recirculating Direct-Fired Units

Energy Savings Mode 2 will automatically disable the burner if the burner's minimum firing rate exceeds the maximum allowable equivalent temperature rise. This condition is unlikely to occur unless the burner's minimum firing rate is misadjusted and set too high, or the inlet air opening is restricted.

Energy Savings Mode 3

Energy Savings Mode 3 will automatically disable the burner if the outside air temperature is above the Heating Economizer setpoint. This function is similar to an inlet duct thermostat. The burner will cycle back on if the supply air temperature drops 3°F below the Heating Economizer setpoint.

Recirculating Direct-Fired Heaters

Using different controller software, the AdaptAire DDC system can accommodate three distinct types of recirculating direct-fired units: those that return air before the burner and employ a special airflow station, those that return air before the burner and do not employ a special airflow station, and those that recirculate air after the burner. Recirculating direct-fired units, like all direct-fired units, deliver all of their products of combustion directly to the heated air space. For this reason it is extremely important that the proper ventilation rate be maintained to dilute these emissions.

AdaptAire units, that recirculate air before the burner and employ an airflow measuring station, utilize a control scheme that measures air pressure to determine the ratio of outside air and return air. These units **are listed** by an independent third party testing agency and use the *equivalent temperature rise* control scheme to limit burner modulation. The AdaptAire system accurately measures the ratio of outside and return air, calculates the allowable *equivalent temperature rise* and automatically limits the burners firing rate. This insures the products of combustion, delivered to the space by the unit, are held at or below allowable OSHA thresholds. The outside air percentage is the driving parameter for this function. A greater percentage of outside air or dilution air enables the unit to generate a higher allowable equivalent temperature rise. The maximum allowable *equivalent temperature rise* for 20% outside air is 48.9°F. The maximum allowable *equivalent temperature rise* increases 1.22°F for each 1% increase in outside air.

AdaptAire units, that recirculate air before the burner and do not employ an airflow measuring station, utilize a control scheme that measures damper position to determine the percentage of return air. These units **are not listed** by an independent third party testing agency but do use the *equivalent temperature rise* control scheme to limit burner modulation. The maximum allowable *equivalent temperature rise* for 20% outside air is 48.9°F. The maximum allowable *equivalent temperature rise* increases 1.22°F for each 1% increase in outside air.

For AdaptAire units that recirculate air before the burner and use the MDT-Expert control, the maximum burner firing rate is limited by the discharge setpoint or the maximum allowable *equivalent temperature rise*, whichever is less.

AdaptAire units that recirculate air after the burner are physically constrained to limit the percentage of return air. These constraints are meant to provide the proper dilution air. These units **are not listed** by an independent third party testing agency and do not use the equivalent temperature rise control scheme to limit burner modulation.

Ventilation Mode

Ventilation Mode occurs when the fan is running but the unit is not providing heating or cooling.

The ventilation mode is dependent on the room (MRT or MRT-Expert) or outside air (MDT or MDT-Expert) temperature. The heating/ventilation/cooling operation is demonstrated below. The dotted line in the middle of the diagram represents the change between room temperature rise and room temperature fall. Select a point on the heavy line in the diagrams on the following pages to determine the mode of operation.

Unoccupied Example: (MRT-Expert only): Start at point “A”. The unit is off, because neither heating nor cooling is required, and the room temperature is rising. Follow the dashed line upward. If the room temperature rises to the cooling setpoint, the fan and cooling will be enabled, and the unit will be in the cooling mode. Follow the solid line clockwise. Once the room temperature has fallen to a temperature that is 2°F below the cooling setpoint, the cooling and fan will be disabled. Follow the dashed line downward. If the room temperature falls to the heating setpoint, the fan and heating will be enabled, and the unit will be in the heating mode. Continue following the solid line in a clockwise direction to the heating setpoint. Once the room temperature rises to a temperature that is 2°F above the heating setpoint, the heating and fan will be disabled.

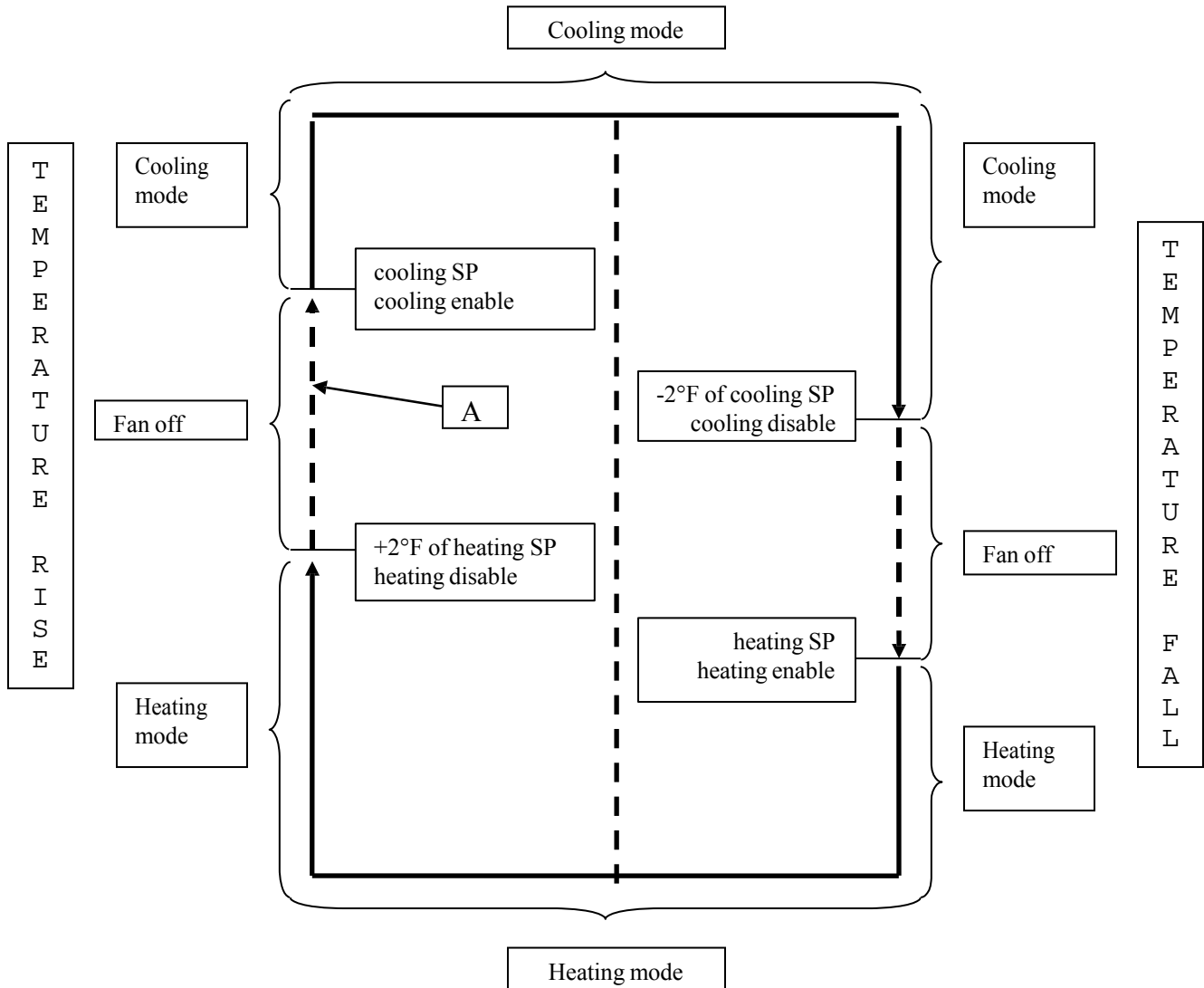

Occupied Example (MRT-Expert only): Start at point “A”. The unit is in the ventilation mode and the room or outside air temperature is rising. Follow the dashed line upward. If the room or outside air temperature rises to a temperature that is 2°F over the cooling setpoint, the cooling will be enabled, and the unit will be in the cooling mode. Follow the solid line clockwise. Once the room or outside air temperature has fallen to the cooling setpoint, the cooling mode will be disabled, and the unit will be in the ventilation mode. Follow the dashed line downward. If the room or outside air temperature falls to a temperature that is 2°F below the heating setpoint, the heating will be enabled, and the unit will be in the heating mode. Continue following the solid line in a clockwise direction to the heating setpoint. Once the room or outside air temperature rises to the heating setpoint, the heating mode will be disabled, and the unit will be in the ventilation mode.

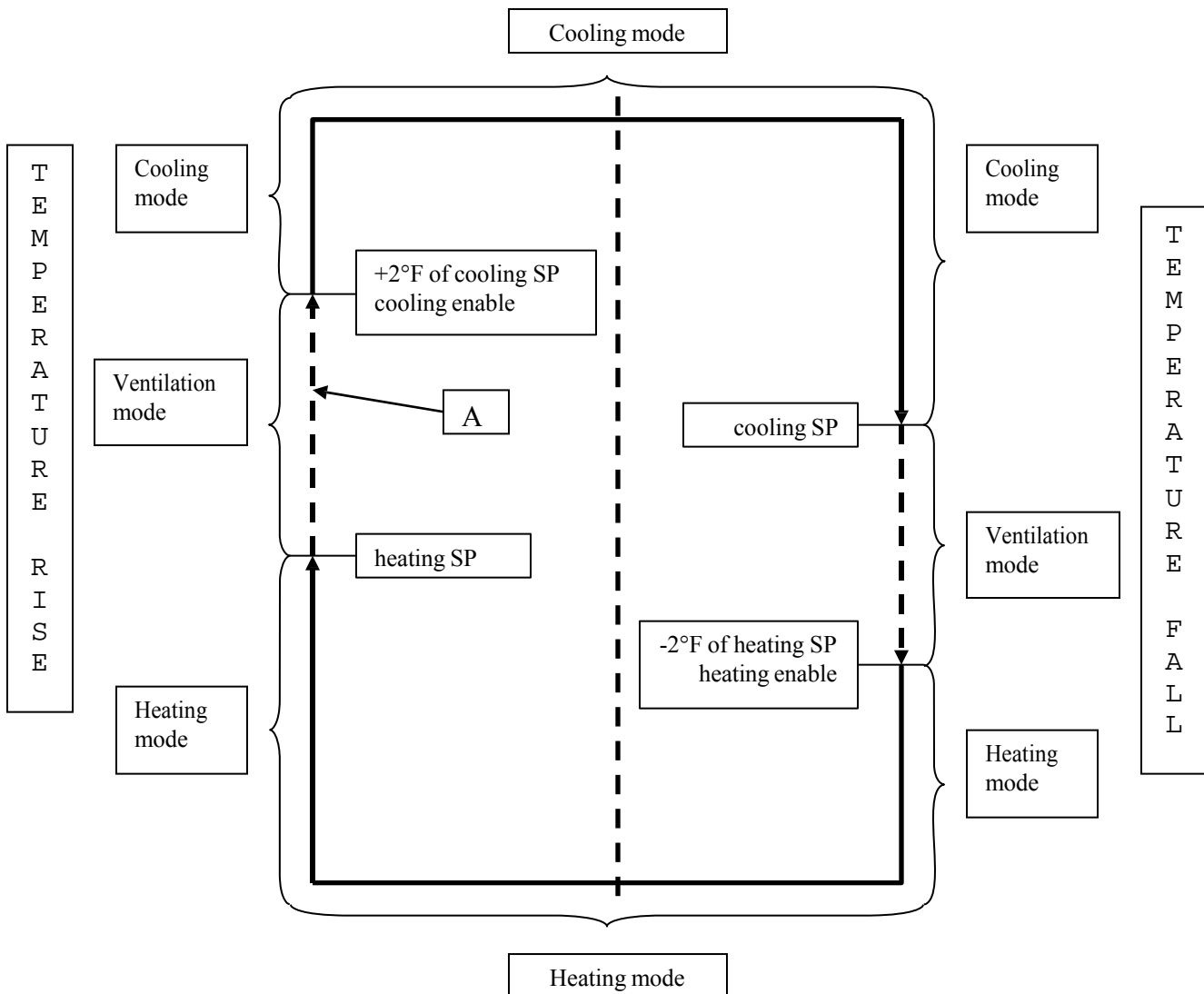

Cooling Mode (MRT)

Overview

In the Cooling Mode of the MRT control system, the cooling outputs will cycle to maintain a constant room temperature and maintain the supply air temperature between the minimum and maximum cooling discharge air temperature setpoints. A call for unit enable and a fan status signal must be present for the cooling outputs to turn on.

In order of lowest to greatest priority, the cooling cycling parameters are minimum cooling discharge air temperature, room temperature, and maximum cooling discharge air temperature.

Cooling is **enabled** if the outside air temperature is above the maximum cooling discharge temperature setpoint or the room temperature is more than 2°F above the cooling occupied setpoint.

Cooling is **disabled** if the outside air temperature is more than 2°F below the maximum cooling discharge air temperature setpoint and the room temperature is below the cooling occupied setpoint or if an Energy Savings Mode is active.

Cooling is **disabled** if the unit enable potentiometer on the *remote control panel* is set to the Off position (turned all the way counter-clockwise).

Room Sensor Failsafe

AdaptAire units configured for MRT control will have a fixed discharge temperature of 70°F if the room temperature sensor is disconnected or otherwise fails to communicate with the unit control module.

Setpoints

To change the desired room temperature setpoint of an MRT control system, rotate the temperature setpoint knob on the *remote control panel* clockwise to the desired temperature. The allowable temperature range is 55°F - 90°F.

General Cooling Control

If cooling is enabled and the room setpoint is not yet satisfied, the unit will maintain the supply air temperature at the minimum cooling discharge air temperature setpoint. As the room temperature begins to fall, the unit will begin to limit the calculated cooling demand. This may limit the supply air temperature by cycling off the cooling output(s) to prevent overcooling the space.

Once the room temperature is satisfied, the calculated cooling demand may be overridden to allow the unit to maintain the supply air temperature below the maximum cooling discharge air temperature setpoint if the outside air temperature is above the maximum cooling discharge air temperature setpoint.

If the minimum and maximum discharge air temperature setpoints are set for the same temperature, the supply air temperature will be the same as the setpoint regardless of the room temperature setpoint or actual room temperature.

The cooling outputs are protected by an anti-cycle timer which has a 3 minute off / 3 minute on delay.

Two Stage Cooling Cycling Sequence

This section describes the cycling sequence of the cooling outputs for units capable of controlling two stages of cooling. These units use the I/O Zone 583 controller.

The cooling demand is expressed as a percentage from 0 to 100 and is calculated by a *PID loop*. If the cooling demand is greater than 25%, stage 1 cooling is enabled. If the cooling demand is greater than 85% for three minutes and a call for stage 1 cooling is present, stage 2 cooling is enabled.

Stage 2 cooling is then disabled when the cooling demand falls below 65% and stage 1 cooling is then disabled when the cooling demand falls below 5%.

Four Stage Cooling Cycling Sequence

The MRT control system does not support the four stage cooling cycling sequence. This sequence requires the I/O Flex 6126 controller which does not support the potentiometer inputs required for an MRT control system. Units that require four stages of cooling must use the MRT-Expert or MDT-Expert control system.

Energy Savings Mode 4

Energy Savings Mode 4 will automatically disable the cooling outputs if the outside air temperature is below the Cooling Economizer setpoint. This function is similar to an inlet duct thermostat. The cooling will cycle back on if the outside air temperature rises 3°F above the Cooling Economizer setpoint.

Cooling Mode (MRT-Expert)

Overview

In the Cooling Mode of the MRT-Expert control system, the cooling outputs will cycle to maintain a constant room temperature and maintain the supply air temperature between the minimum and maximum cooling discharge air temperature setpoints. A call for unit enable and a fan status signal must be present for the cooling outputs to turn on.

In order of lowest to greatest priority, the cooling cycling parameters are minimum cooling discharge air temperature, room temperature, and maximum cooling discharge air temperature.

Room Sensor Failsafe

AdaptAire units configured for MRT-Expert controls will have a fixed discharge temperature of 70°F if the room temperature sensor is disconnected or otherwise fails to communicate with the unit control module. When the room sensor fails to communicate with the controller, a room temperature of 0°F will display on the *BACview*.

Setpoints

Navigate to Setpoints on the *BACview* to change cooling setpoints.

Occupied Mode

Cooling is **enabled** if the outside air temperature is above the maximum cooling discharge temperature setpoint or the room temperature is more than 2°F above the cooling occupied setpoint.

Cooling is **disabled** if the outside air temperature is more than 2°F below the maximum cooling discharge air temperature setpoint and the room temperature is below the cooling occupied setpoint or if an Energy Savings Mode is active.

Unoccupied / Night Setback Mode

Cooling is **enabled** if the room temperature is above the cooling night setback setpoint.

Cooling is **disabled** if the room temperature is 2°F below the cooling night setback setpoint or if an Energy Savings Mode is active.

General Cooling Control

If cooling is enabled and the room setpoint is not yet satisfied, the unit will maintain the supply air temperature at the minimum cooling discharge air temperature setpoint. As the room temperature begins to fall, the unit will begin to limit the calculated cooling demand. This may limit the supply air temperature by cycling off the cooling output(s) to prevent overcooling the space.

Once the room temperature is satisfied, the calculated cooling demand may be overridden to allow the unit to maintain the supply air temperature below the maximum cooling discharge air temperature setpoint if the outside air temperature is above the maximum cooling discharge air temperature setpoint.

If the minimum and maximum discharge air temperature setpoints are set for the same temperature, the supply air temperature will be the same as the setpoint regardless of the room temperature setpoint or actual room temperature.

The cooling outputs are protected by an anti-cycle timer which has a 3 minute off / 3 minute on delay.

Two Stage Cooling Cycling Sequence

This section describes the cycling sequence of the cooling outputs for units capable of controlling two stages of cooling. These units use the I/O Zone 583 controller.

The cooling demand is expressed as a percentage from 0 to 100 and is calculated by a *PID loop*. If the cooling demand is greater than 25%, stage 1 cooling is enabled. If the cooling demand is greater than 85% for three minutes and a call for stage 1 cooling is present, stage 2 cooling is enabled.

Stage 2 cooling is then disabled when the cooling demand falls below 65% and stage 1 cooling is then disabled when the cooling demand falls below 5%.

Four Stage Cooling Cycling Sequence

This section describes the cycling sequence of the cooling outputs for units capable of controlling four stages of cooling. These units use the I/O Flex 6126 controller.

The cooling demand is expressed as a percentage from 0 to 100 and is calculated by a *PID loop*. If the cooling demand is greater than 25%, stage 1 cooling is enabled. If the cooling demand is greater than 50% for three minutes and a call for stage 1 cooling is present, stage 2 cooling is enabled. If the cooling demand is greater than 75% for three

minutes and a call for stage 2 cooling is present, stage 3 cooling is enabled. If the cooling demand is greater than 95% for three minutes and a call for stage 3 cooling is present, stage 4 cooling is enabled.

Stage 4 cooling is then disabled when the cooling demand falls below 80%. Stage 3 cooling is then disabled when the cooling demand falls below 55%. Stage 2 cooling is then disabled when the cooling demand falls below 30%. Stage 1 cooling is then disabled when the cooling demand falls below 5%.

Energy Savings Mode 4

Energy Savings Mode 4 will automatically disable the cooling outputs if the outside air temperature is below the Cooling Economizer setpoint. This function is similar to an inlet duct thermostat. The cooling will cycle back on if the outside air temperature rises 3°F above the Cooling Economizer setpoint.

Cooling Mode (MDT)

Overview

In the Cooling Mode of the MDT control system, the cooling outputs will cycle to maintain a constant supply air temperature. A call for unit enable and a fan status signal must be present for the cooling outputs to turn on.

Cooling is **enabled** if the outside air temperature is more than 2°F above the heating/cooling changeover setpoint.

Cooling is **disabled** if the outside air temperature is below the heating/cooling changeover setpoint..

Cooling is **disabled** if the unit enable potentiometer on the *remote control panel* is set to the Off position (turned all the way counter-clockwise).

Setpoints

To change the desired cooling discharge temperature of an MDT control system, rotate the temperature setpoint knob on the *remote control panel* clockwise to the desired temperature. The allowable temperature range is 55°F - 90°F.

General Cooling Control

If cooling is enabled, the unit will maintain the supply air temperature at the discharge air temperature setpoint.

Two Stage Cooling Cycling Sequence

This section describes the cycling sequence of the cooling outputs for units capable of controlling two stages of cooling. These units use the I/O Zone 583 controller.

The cooling demand is expressed as a percentage from 0 to 100 and is calculated by a *PID loop*. If the cooling demand is greater than 25%, stage 1 cooling is enabled. If the cooling demand is greater than 85% for three minutes and a call for stage 1 cooling is present, stage 2 cooling is enabled.

Stage 2 cooling is then disabled when the cooling demand falls below 65% and stage 1 cooling is then disabled when the cooling demand falls below 5%.

Four Stage Cooling Cycling Sequence

The MDT control system does not support the four stage cooling cycling sequence. This sequence requires the I/O Flex 6126 controller which does not support the potentiometer inputs required for an MDT control system. Units that require four stages of cooling must use the MRT-Expert or MDT-Expert control system.

Energy Savings Mode 4

Energy Savings Mode 4 will automatically disable the cooling outputs if the outside air temperature is below the Cooling Economizer setpoint. This function is similar to an inlet duct thermostat. The cooling will cycle back on if the outside air temperature rises 3°F above the Cooling Economizer setpoint.

Cooling Mode (MDT-Expert)

Overview

In the Cooling Mode of the MDT-Expert control system, the cooling outputs will cycle to maintain a constant supply air temperature. A call for unit enable and a fan status signal must be present for the cooling outputs to turn on.

Setpoints

Navigate to Setpoints on the *BACview* to change setpoints.

Scheduled On Mode

Scheduled On mode refers to any time the unit is running based on an ON schedule.

Cooling is **enabled** if the outside air temperature is more than 2°F above the heating/cooling changeover setpoint in Scheduled On mode.

Cooling is **disabled** if the outside air temperature is below the heating/cooling changeover setpoint in Scheduled On mode.

Scheduled Off Mode

Scheduled Off mode refers to any time the unit is outside of the time ranges of any ON schedules. Cooling is **disabled** in Scheduled Off mode.

General Cooling Control

If cooling is enabled, the unit will maintain the supply air temperature at the discharge air temperature setpoint.

Two Stage Cooling Cycling Sequence

This section describes the cycling sequence of the cooling outputs for units capable of controlling two stages of cooling. These units use the I/O Zone 583 controller.

The cooling demand is expressed as a percentage from 0 to 100 and is calculated by a *PID loop*. If the cooling demand is greater than 25%, stage 1 cooling is enabled. If the

cooling demand is greater than 85% for three minutes and a call for stage 1 cooling is present, stage 2 cooling is enabled.

Stage 2 cooling is then disabled when the cooling demand falls below 65% and stage 1 cooling is then disabled when the cooling demand falls below 5%.

Four Stage Cooling Cycling Sequence

This section describes the cycling sequence of the cooling outputs for units capable of controlling four stages of cooling. These units use the I/O Flex 6126 controller.

The cooling demand is expressed as a percentage from 0 to 100 and is calculated by a *PID loop*. If the cooling demand is greater than 25%, stage 1 cooling is enabled. If the cooling demand is greater than 50% for three minutes and a call for stage 1 cooling is present, stage 2 cooling is enabled. If the cooling demand is greater than 75% for three minutes and a call for stage 2 cooling is present, stage 3 cooling is enabled. If the cooling demand is greater than 95% for three minutes and a call for stage 3 cooling is present, stage 4 cooling is enabled.

Stage 4 cooling is then disabled when the cooling demand falls below 80%. Stage 3 cooling is then disabled when the cooling demand falls below 55%. Stage 2 cooling is then disabled when the cooling demand falls below 30%. Stage 1 cooling is then disabled when the cooling demand falls below 5%.

Energy Savings Mode 4

Energy Savings Mode 4 will automatically disable the cooling outputs if the outside air temperature is below the Cooling Economizer setpoint. This function is similar to an inlet duct thermostat. The cooling will cycle back on if the outside air temperature rises 3°F above the Cooling Economizer setpoint.

Damper Control Modes

Overview

There are four different modes that control the unit damper operation: Manual, Mixed Air Temperature, Building Pressure, and 100% Outside Air. Not all damper modes are available on all units.

To change the Damper Mode (except for 100% Outside Air mode), navigate to Unit Modes on the *BACview*. Change the Damper Mode parameter to the desired Damper Mode.

Outside air dampers will remain in the fully closed position and return air dampers will remain in the fully open position any time the fan is not running. A fan status signal must be present for the dampers to operate in manual, mixed air, or building pressure mode. The 100% outside air mode will function even if the fan is not running, driving the outside air dampers fully open and the return air dampers fully closed. If the fan is running, the 100% outside air mode will override the manual, mixed air, and building pressure modes.

Manual mode is the default damper operation mode for all units except for units with 75/25 dampers. The default damper operation mode for 75/25 units is the building pressure mode.

Minimum Ventilation

Changing the Minimum Ventilation setpoint requires the use of an *BACview* or PC. The Minimum Ventilation function defines the minimum outside air percentage and automatically prevents the dampers from modulating below this point. This function applies to heating, cooling, and ventilation modes.

If the unit served by this control is a direct-fired heater that recirculates air before the burner, and is operating in the heating mode, the unit will automatically keep the minimum outside air at 20%. If the outside air drops below 20%, the burner will cycle off.

To specify the Minimum Ventilation, navigate to Unit Setpoint on the *BACview* and set the Minimum Ventilation setpoint to a percentage corresponding to the minimum percentage of outside air desired. The allowable range is 0% - 100% outside air. By physical design, direct-fired heaters that recirculate air after the burner supply a minimum of 25% outside air.

Manual Mode

Manual Mode sets the outside air damper to a fixed position on units without a return airflow station.

On units with a return airflow station, a PID loop controls the outside air damper position so the position of the dampers can be variable. The damper position may change as the return air pressure changes to maintain a fixed percentage of outside air according to the Manual Ventilation setpoint. A PID loop with a 2% deadband prevents the dampers from changing position in the manual mode unless the calculated percentage of outside air is more than 2% away from setpoint.

If the unit served by this control is a direct-fired heater that recirculates air after the burner, the unit is designed to provide a minimum of 25% outside air.

If the unit served by this control is a direct-fired heater that recirculates air before the burner, and is operating in the heating mode, the unit will automatically keep the minimum outside air at 20%. If the outside air drops below 20%, the burner will cycle off. **See Minimum Ventilation.**

MRT and MDT Controls

To place the damper operation in Manual Mode on an MDT or MRT control system be sure the appropriate terminals in the unit control panel are **not** shorted. See the Typical Wiring Schematic and Multiplexed Input sections of this manual for more information. Rotate the damper control knob on the *remote control panel* to the desired percentage of outside air.

MRT-Expert and MDT-Expert Controls

To place the damper operation in Manual Mode on an MRT-Expert or MDT-Expert control system, navigate to Unit Modes on the *BACview*. Change the Damper Mode

parameter to “Manual”. Next, navigate to Unit Setpoints on the *BACview*. Change the Manual Ventilation setpoint parameter to the desired damper position, expressed as a percentage of outside air. The allowable range is 0% to 100%.

Mixed Air Temperature Mode

The Mixed Air Temperature mode varies the percentages of outside air and return air to maintain a constant mixed air temperature.

If the room sensor fails to communicate with the controller, the room sensor failsafe mode will enable to maintain the discharge temperature at 70°F and the damper mode will default to manual control. An Invalid Damper Control Mode alarm will be generated and will clear automatically once room sensor communications are restored or the damper mode is manually changed to a setting other than mixed air temperature control.

The controller computes the mixed air temperature using the outside air and return air temperatures and the ratio of their respective airflows. Direct fired units that recirculate after the burner do not have mixed air temperature control. A PID loop with a 2°F deadband prevents the dampers from changing position in the mixed air mode unless the mixed air temperature is more than 2°F away from setpoint.

If the unit served by this control is a direct-fired heater, that recirculates air before the burner, and is operating in the heating mode, the unit will automatically keep the minimum outside air at 20%. If the outside air drops below 20%, the burner will cycle off. **See Minimum Ventilation.**

MDT and MDT-Expert Controls

The mixed air temperature control mode is not supported on MDT or MDT-Expert systems because a room/return air temperature is not available with that system to allow the mixed air temperature to be calculated correctly.

MRT Controls

To place the damper operation in Mixed Air Temperature Mode on an MRT control system be sure the appropriate terminals in the unit control panel are shorted. See the Typical Wiring Schematic and Multiplexed Input sections of this manual for more information. Rotate the damper control knob on the *remote control panel* to the desired mixed air temperature. The allowable range is 55°F - 90°F.

MRT-Expert Controls

To place the damper operation in Mixed Air Mode on an MRT-Expert control system, navigate to Unit Modes on the *BACview*. Change the Damper Mode parameter to “MA Temp Ctrl”. Next, navigate to Unit Setpoint on the *BACview*. Change the mixed air temperature setpoint parameter to the desired mixed air temperature. The allowable range is 30°F - 90°F.

Building Pressure Mode

The Building Pressure mode varies the percentages of outside air and return air to maintain a constant pressure within the space.

A pressure transducer compares the pressure outside the space to the pressure inside the space and transmits a corresponding signal to the controller. The controller compares this signal to the desired building pressure setpoint and uses a *PID* loop to modulate the outside air and return air dampers to maintain the specified building pressure. A PID loop with a 0.01" W.C. deadband prevents the dampers from changing position in the building pressure mode unless the building pressure is more than 0.01" W.C. away from setpoint.

MRT and MDT Controls

The MRT and MDT control systems do not support building pressure control mode.

MRT-Expert and MDT-Expert Controls

To place the damper operation in Building Pressure Mode on an MRT-Expert or MDT-Expert control system, navigate to Unit Modes on the *BACview*. Change the Damper Mode parameter to "Bldg Pres Ctrl". Next, navigate to Unit Setpoint on the *BACview*. Change the building pressure setpoint parameter to the desired building pressure. The allowable range is -0.05" W.C. to +0.05" W.C.

If the unit served by this control is a direct-fired heater that recirculates air before the burner, and is operating in the heating mode, the unit will automatically keep the minimum outside air at 20%. If the outside air drops below 20%, the burner will cycle off. See **Minimum Ventilation**.

100% Outside Air Mode

The 100% Outside Air function automatically opens the outside air dampers and closes the return air dampers.

MRT, MRT-Expert, MDT, and MDT-Expert Controls

This function is activated whenever a contact is closed between the appropriate terminals on the unit's terminal strip located in the unit's main control panel. See the Typical Wiring Schematic and Multiplexed Input sections of this manual for more information. The 100% Outside Air function overrides all other damper control functions.

On non-recirculating units, the 100% outside air function drives the user-configured output to its maximum value of 10 VDC.

Freezestat

The Freezestat function automatically cycles the unit off if the supply air temperature drops below the Freezestat setpoint for a certain period of time. The default for the Freezestat setpoint is 45°F. To change the Freezestat setpoint, navigate to Unit Setpoints on the *BACview* and change the Freezestat setpoint to the desired temperature. The allowable temperature range is 35°F - 80°F.

The On all units, there is a 5-minute delay that begins once the supply fan is given a run command. During this 5-minute delay period, the Freezestat function is disabled to give the discharge temperature enough time to reach operating temperature after a cold start. After the initial 5-minute delay period, the Freezestat is activated anytime the supply fan is commanded to be on and the supply air temperature is below the Freezestat setpoint for longer than the duration set by the Freezestat Buffer Time setpoint (the default value is 3 minutes).

For example, with the supply air temperature below the freezestat setpoint and the freezestat buffer time setpoint set at 3 minutes, the freezestat will not trip until both the 5-minute initial cold-start delay period and the 3 minute freezestat buffer time setpoint have elapsed. Once the unit has been running, anytime the supply air temperature drops below the freezestat setpoint, the freezestat will not trip until a period of time equal to the freezestat buffer time setpoint has elapsed.

To change the Freezestat Buffer Time setpoint, navigate to Unit Setpoints on the *BACview* and change the Freezestat Buffer Time setpoint to the desired duration. The allowable time range or duration is 3 - 9 minutes.

Clogged Filter

An optional clogged filter switch is required for this function. The Clogged Filter function automatically notifies the user of a dirty filter condition. A Clogged Filter alarm will appear on the *BACview*. This function is activated whenever a contact is closed between the appropriate terminals on the unit's terminal strip located in the unit's main control panel. See the Typical Wiring Schematic and Multiplexed Input sections of this manual for more information.

Multiplexed Inputs

This section applies to I/O Zone 583 controllers only. DDC controllers are designed with a finite number of inputs and outputs. Multiplexing expands the functionality of the controller by allowing multiple devices to effectively share the same input. This is usually accomplished by connecting resistors, either in a series or parallel configuration, to an analog input. A switch is used in conjunction with each resistor. When a switch is closed, the resistance at the controller input changes. This allows the controller to identify which switch has closed. The controller is programmed to associate each different resistance with a specific function. For example when the optional clogged filter switch is closed between the appropriate terminals on the unit's terminal strip located in the unit's main control panel, this tells the controller that the filters are clogged, and it notifies the user through the *BACview*. See the table below for a complete list of inputs in the multiplexed circuits and how their open and closed states relate to the resistance in the circuit and the voltage at controller inputs IN-3 and IN-4.

RESISTOR VALUE	RESISTOR ID	SWITCH CLOSED	OHMS IN CIRCUIT	ZN 583 VOLTS DC
1000	RS1	RS1,2,3,4	0	0
2000	RS2	RS2,3,4	1000	0.30
4020	RS3	RS1,3,4	2000	0.55
8060	RS4	RS3,4	3000	0.76
MULTIPLEXED VOLTAGE VALUES		RS1,2,4	4020	0.95
		RS2,4	5020	1.10
		RS1,4	6020	1.24
		RS4	7020	1.36
		RS1,2,3	8060	1.47
		RS2,3	9060	1.57
		RS1,3	10060	1.65
		RS3	11060	1.73
		RS1,2	12080	1.80
		RS2	13080	1.87
		RS1	14080	1.92
		NONE	15080	1.98
		UNPLUGGED	NA	3.30

IN-3	JUMPER	RS-04	MIXED AIR TEMP
	RE-56	RS-03	SAFETY CKT STATUS
	RE-09	RS-02	FLAME FAILURE
	SW-72	RS-01	100% OA or 100% OUTPUT
IN-4	RE-27	RS-04	BURNER STATUS
	RE-65	RS-03	FAN STATUS
	RE-12	RS-02	CLOGGED FILTER
	SW-09	RS-01	AUXILIARY UNIT ENABLE

Menu Selection Tree for BACview

This section will assist the user in navigating the menu functions of the control program. For convenience Hotkeys are provided to allow the user to jump directly to a specific menu heading. Simply press and hold the FN key. While holding the FN key, press the number key of the desired menu, and it will appear. The number key associated with the menu heading is shown below. Links to other menu headings are also available by pressing one of the 4 keys located directly below the screen.

Special Functions:

- FN + MUTE = Clear Alarms
- FN + period = Module Status (modstat)
- FN + 9 = Unit Setup

Access to the Unit Setup page requires the Admin Password. Changes to the Unit Setup page after the unit leaves the factory can adversely affect unit operation in the field. Do not make changes to the parameters on the Unit Setup page without first contacting the factory.

The default password for the user account is **0000**. The default password for the admin account is **1111**.

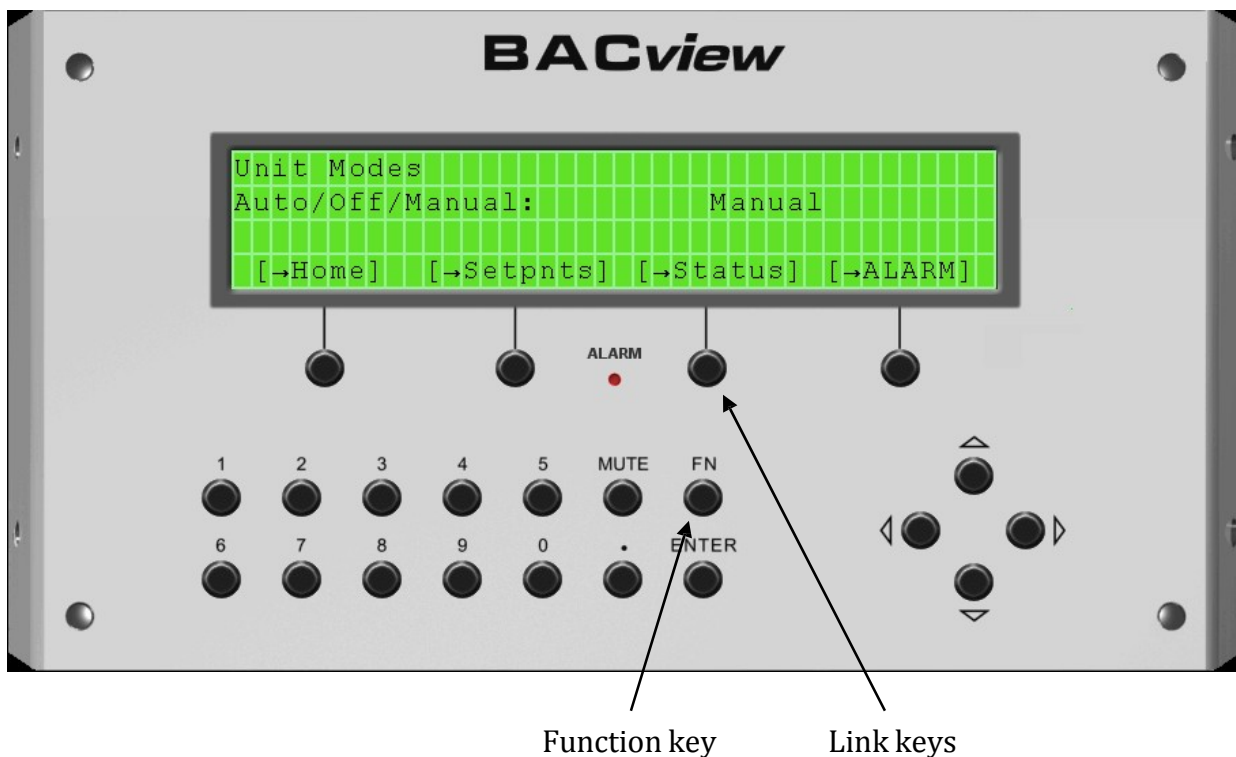

The following procedure describes how to change an operational parameter of the unit via the *BACview*. In this example, we will use the Unit Modes screen to change the unit mode from Off to Manual.

1. The Home screen shows contact information on the backlit display. From the Home screen, press the MODES link key that corresponds to the Unit Modes

screen. The link keys are located just below the backlit display as shown in the previous figure.

2. The Unit Modes screen will appear on the backlit display. The unit ships from the factory with the Auto/Off/Manual parameter set to Off. To change this parameter to Manual or Auto, use the arrow keys to move the cursor so that "Off" is selected. When "Off" is selected by the cursor, it will appear on the screen surrounded by brackets: "[Off]".
3. Press the **ENTER** button. "Off" will flash on the screen, indicating that this value is now editable. Use the link keys corresponding to INCR and DECR to scroll through the available parameter values, which are Auto, Off, and Manual. Set the value of the parameter to Manual and press the **ENTER** button.
4. Once the system has accepted this new parameter value, the unit will run continuously in Manual mode. Use a similar procedure to make changes to other operational parameters and setpoints as necessary.

MODSTAT

The modstat (module status) screen allows the user to check the program version number and whether the programs are initialized and running. If the red error LED is flashing on the module, a modstat is a useful troubleshooting tool. Perform the modstat by pressing and holding the FN key and then pressing the period key and then releasing both keys at the same time. Scroll down until you see the following message:

2 PRGs initialized. 2 PRGs running.

If this message is not visible anywhere on the modstat screen (after scrolling through the whole screen), contact the factory to troubleshoot the issue with the unit control module. There is likely an issue with the unit control module that is preventing the unit from functioning correctly.

The name of the main control program and its version number can also be seen on the modstat screen, for example:

Application Software Version: ifrrecircz583_032813

For networking purposes, the device instance number can also be accessed via the modstat function, for example:

Device Instance: 0024009

UNIT MODES HOTKEY - 2

- Auto/Off/Man
 - Auto
 - Off
 - Manual
- Damper Mode
 - MATempCtrl

- BldgPressCtrl
- ManualCtrl
- Home
- Setpoints
- Status
- Alarm

SETPOINTS *HOTKEY - 3*

- Htg Occupied °F range 40-130
- Htg Setback °F range 40-130
- Htg Min DA °F range 40-130
- Htg Max DA °F range 40-130
- Clg Occupied °F range 40-130
- Clg Setback °F range 40-130
- Clg Min DA °F range 40-130
- Clg Max DA °F range 40-130
- Man Vent %OA range 0-100
- Mixed Air °F range 30-90
- Bldg Pres “WC range -0.10-+0.10
- Min Vent % range 0-100
- Htg Economizer Temp °F range 40-130
- Clg Economizer Temp °F range 40-130
- Freeze Stat °F range 35-80
- OA Temp for Htg/Clg Changeover °F range 40-130
- Htg DA Temp °F range 40-130
- Clg DA Temp °F range 40-130
- Home
- Status
- Alarm
- Resets

STATUS MENU *HOTKEY - 4*

The Status Menu always displays the current status of the fan, burner and cooling.

- Room Temp °F
- OA or Inlet Temp °F
- DA Temp °F
- MA Temp °F
- Outside Air %
- Bldg Pres “WC
- Energy Save Mode
- Fan Cycles
- Fan Hours
- Bnr Cycles
- Bnr Hours
- Clg Cycles
- Clg Hours
- Damper VDC

- Burner VDC
- Burner Gas VDC
- Burner Air VDC
- Safety Ckt Open/Closed
- ActEQ Temp °F
- MaxEQ Temp °F
- Home
- Alarm
- Resets
- Help

ALARM *HOTKEY - 1*

- Module Event History (100 Most Recent)
 - Active Alarms
 - Active Faults
 - Returned-To-Normal
 - Manually Cleared
 - Previous

RESETS *HOTKEY - 6*

- Alarm
- Burner Reset
- Fan Count
- Cooling Reset
- Calibrate
- Home
- Schedules
- Clock Set
- Help

SCHEDULES *HOTKEY - 7*

- 24 hr Operation yes/no
- Daily
 - Schedule1 (typical 1 through 4)
 - Use yes/no
 - Start Time hr:min
 - Stop Time hr:min
 - DAYS SUN, MON, TUE, WED, THU, FRI, SAT
 - Previous
 - Next
 - Home
 - Logout
- Holiday
 - Holiday1 (typical 1 through 12)
 - Use yes/no
 - Start Time hr:min
 - Stop Time hr:min

- Month (1-12)
- Day (1-31)
- Previous
- Next
- Home
- Logout
- Override
 - Override1 (typical 1 through 2)
 - Use yes/no
 - Start Time hr:min
 - Stop Time hr:min
 - Month (1-12)
 - Day (1-31)
 - Previous
 - Next
 - Home
 - Logout

CLOCKSET

HOTKEY - 0

- Time hh:mm:ss
- Date dd-mm-yy
- Previous
- DST
 - Start Time hh:mm
 - Amount 060
 - Beg Mar 11 2012 End Nov 04 2012
 - Beg Mar 10 2013 End Nov 03 2013
 - Beg Mar 09 2014 End Nov 02 2014
 - Beg Mar 08 2015 End Nov 01 2015
 - Beg Mar 13 2016 End Nov 06 2016
 - Beg Mar 12 2017 End Nov 05 2017
 - Beg Mar 11 2018 End Nov 04 2018
 - Beg Mar 10 2019 End Nov 03 2019
 - Beg Mar 08 2020 End Nov 01 2020
 - Beg Mar 14 2021 End Nov 07 2021
 - Previous

HELP

HOTKEY - 5

- Fan Sequence
- Room Sensor
- Heating Sequence
- Cooling Sequence
- Schedule Sequence
- Calibrate Sequence
- User Configured Output
- Previous
- Home
- Alarm

- User Config

USER CONFIGURABLE OUTPUT HOTKEY - 8

- User Control Setpoint
- User Input Variable
- User Output %
- PID Select Direct Acting / Reverse Acting
- High Input Value
- Low Input Value
- Maximum User Setpoint
- Minimum User Setpoint
- Previous
- Home
- Setpoints
- Help

UNIT SETUP HOTKEY - 9

Access to the Unit Setup page requires the Admin Password. Changes to the Unit Setup page after the unit leaves the factory can adversely affect unit operation in the field. Do not make changes to the parameters on the Unit Setup page without first contacting the factory.

- Brand Applied Air / Temprite / Sterling / Trane / LJ Wing
- Fuel Type Natural Gas / Propane
- Duct Furnace Size IFD-160 / IFD-320 / IFD-480 / Other
- Control System MRT (modulating room temperature) / MDT (modulating discharge temp)

Protocol Setup

This section will assist the user in configuring the DDC controller for one of the available field communication protocols.

The following image shows the location of various configuration jumper and switches:

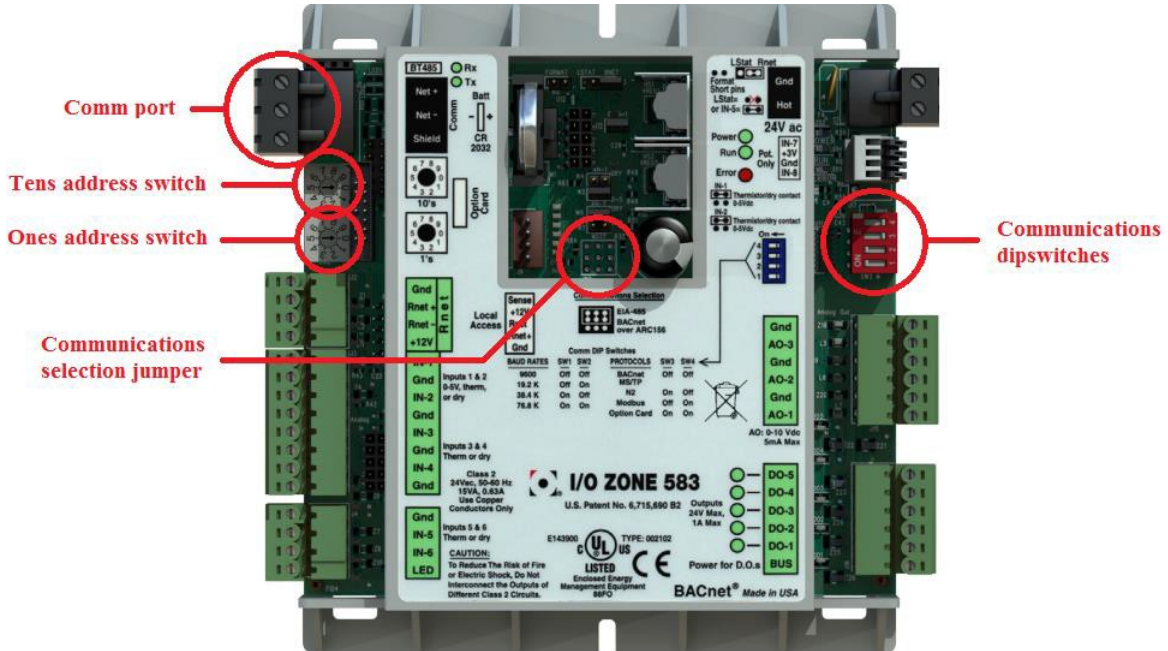

BACnet MS/TP

To configure the controller to communicate in BACnet MS/TP protocol, complete the following procedure:

1. Turn off the power for the I/O Zone 583.
2. Using the rotary address switches on the left-hand side of the controller, set a unique address. Set the tens switch to the tens digit of the address and set the ones switch to the ones digit.
3. Set the Communications Selection jumper to the EIA-485 position.
4. Set communications dipswitches 1 and 2 on the right-hand side of the controller to the appropriate position for the desired communication speed (baud rate). All devices on the same network must be set to the same communications speed. Dipswitches are On when the switch is toward the left-hand side of the controller (indicated by a small arrow and the word "On" on the dipswitch block) and Off when the switch is toward the right-hand side of the controller.

Baud rate	Dipswitch 1	Dipswitch 2
9,600 bps	Off	Off
19.2 kbps	Off	On
38.4 kbps	On	Off
76.8 kbps	On	On

5. Set communications dipswitches 3 and 4 to the Off position.

- Connect the communications wiring to the Comm port in the screw terminals labeled Net +, Net -, and Shield. Use a dedicated 24 AWG to 18 AWG twisted pair wire (EIA-485). Maximum length should be 2,000 ft for 76.8 kbps baud rate or 3,000 feet for 9600 bps, 19.2 kbps, or 38.4 kbps baud rate. Devices should be daisy chained and not star wired. Use the same polarity throughout the network.

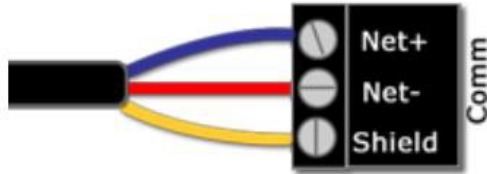

- Turn on power for the I/O Zone 583.

Modbus

To configure the controller to communicate in Modbus protocol, complete the following procedure:

- Turn off the power for the I/O Zone 583.
- Using the rotary address switches on the left-hand side of the controller, set a unique address. Set the tens switch to the tens digit of the address and set the ones switch to the ones digit.
- Set the Communications Selection jumper to the EIA-485 position.
- Set communications dipswitches 1 and 2 on the right-hand side of the controller to the appropriate position for the desired communication speed (baud rate). All devices on the same network must be set to the same communications speed. Dipswitches are On when the switch is toward the left-hand side of the controller (indicated by a small arrow and the word “On” on the dipswitch block) and Off when the switch is toward the right-hand side of the controller.

Baud rate	Dipswitch 1	Dipswitch 2
9,600 bps	Off	Off
19.2 kbps	Off	On
38.4 kbps	On	Off
76.8 kbps	On	On

- Set communications dipswitches 3 to the Off position and 4 to the On position.
- Connect the communications wiring to the Comm port in the screw terminals labeled Net +, Net -, and Shield. Use a dedicated 24 AWG to 18 AWG twisted pair wire (EIA-485). Maximum length should be 2,000 ft for 76.8 kbps baud rate or 3,000 feet for 9600 bps, 19.2 kbps, or 38.4 kbps baud rate. Devices should be daisy chained and not star wired. Use the same polarity throughout the network.



7. Turn on power for the I/O Zone 583.

N2

To configure the controller to communicate in N2 protocol, complete the following procedure:

1. Turn off the power for the I/O Zone 583.
2. Using the rotary address switches on the left-hand side of the controller, set a unique address. Set the tens switch to the tens digit of the address and set the ones switch to the ones digit.
3. Set the Communications Selection jumper to the EIA-485 position.
4. Set communications dipswitches 1 and 2 on the right-hand side of the controller to the appropriate position for the desired communication speed (baud rate). Dipswitches 1 and 2 must be set to the Off position for N2 (9,600 bps). All devices on the same network must be set to the same communications speed. Dipswitches are On when the switch is toward the left-hand side of the controller (indicated by a small arrow and the word “On” on the dipswitch block) and Off when the switch is toward the right-hand side of the controller.

Baud rate	Dipswitch 1	Dipswitch 2
9,600 bps	Off	Off

5. Set communications dipswitches 3 to the On position and 4 to the Off position.
6. Connect the communications wiring to the Comm port in the screw terminals labeled Net +, Net -, and Shield. Use a dedicated 24 AWG to 18 AWG twisted pair wire (EIA-485). Maximum length should be 3,000 feet for 9600 bps baud rate. Devices should be daisy chained and not star wired. Use the same polarity throughout the network.



7. Turn on power for the I/O Zone 583.

LonWorks

The LonWorks Option card is initialized with the I/O Zone 583 controller during the unit testing procedure. If either the LonWorks Option Card or the I/O Zone 583 fails to operate for any reason, contact the factory to help resolve the issue.

To configure the controller to communicate in LonWorks protocol, complete the following procedure:

1. Turn off the power for the I/O Zone 583.
2. Using the rotary address switches on the left-hand side of the controller, set a unique address. Set the tens switch to the tens digit of the address and set the ones switch to the ones digit.

3. Set the Communications Selection jumper to the EIA-485 position.
4. Set communications dipswitches 1 and 2 on the right-hand side of the controller to the appropriate position for the desired communication speed (baud rate). All devices on the same network must be set to the same communications speed. Dipswitches are On when the switch is toward the left-hand side of the controller (indicated by a small arrow and the word “On” on the dipswitch block) and Off when the switch is toward the right-hand side of the controller.

Baud rate	Dipswitch 1	Dipswitch 2
9,600 bps	Off	Off
19.2 kbps	Off	On
38.4 kbps	On	Off
76.8 kbps	On	On

5. Set communications dipswitches 3 and 4 to the On position.
6. Connect the LON network to pins 1 and 2 on the LonWorks Option Card.
7. Turn on power for the I/O Zone 583.

Diagnositics – Critical Alarm Codes

This section should assist the user in troubleshooting critical alarm codes messages that have been displayed on the *BACview*. These alarms almost always require the operator to correct the condition and manually reset the alarm before normal unit operation resumes. Exceptions to this rule are noted in the alarm problem descriptions that follow.

ALARM CODE: **Freezestat**

PROBLEM: The controller has detected a low temperature at the unit discharge and has shut off the unit. See Freezestat section of this manual.

SOLUTION: If burner was operating prior to shutdown (check prior alarm log)

1. Is the outside air (OA Temp) or room air (Room Temp) displayed on the *BACview* reading 150°F or more?
 - a. Yes. That sensor circuit or the sensor itself is shorted. Unplug the input jack from the AdaptAire controller. Did the display change to -40°F or less?
 - 1) No. There is a short in the controller input. Replace the controller.
 - 2) Yes. Disconnect the sensor wiring at the sensor. Connect an ohmmeter to the sensor. If it is shorted replace the sensor. At 77°F the resistance should be 10KΩ. See thermistor output curve for other temperatures. If it is not shorted, there is a short in the wiring between the sensor and the input plug. Determine cause and rectify. Refer to Appendix A for a typical 10KΩ thermistor output curve.
 - b. No. Continue.
2. Is the discharge air temperature (DA Temp), displayed on the *BACview* keypad, reading -40°F or less?
 - a. Yes. That sensor circuit or the sensor itself is open. Jumper the input for the sensor. Did the display change to 150°F or more?
 - 1) No. There is an open in the controller input. Replace the controller.
 - 2) Yes. Disconnect the sensor wiring at the sensor. Connect an ohmmeter to the sensor. If it is open replace the sensor. At 77°F the resistance should be 10KΩ. See thermistor output curve for other temperatures. If it is not open, there is a break in the wiring between the sensor and the input plug. Determine cause and rectify.
 - b. No. Continue
3. Reset the alarm. Check and note the DC voltage at output for the gas valve modulation. Set the Heating Occupied and Night Setback Setpoints for 130°F. Set the Heating Minimum and Maximum DA Temp Setpoints for 130°F. Did the Burner VDC, displayed on the *BACview*, increase?
 - a. No. Unless the outside air temperature is extremely warm the Burner VDC should have increased to 7.5VDC or more. Close the manual main gas valve closest to the burner and measure the discharge air temperature. Is it less than 130°F?
 - 1) Yes. There is a problem with the controller program or controller itself. Contact the factory.

- 2) No. The outside air temperature is too hot to determine the actual cause of the problem. Reset the alarm and recheck when the outside air temperature is much cooler.
- b. Yes. This signal is fed to the gas valve modulation signal conditioner. Disconnect the wires from input signal terminals on the signal conditioner and measure the voltage on the wires. Is it the same as the voltage coming from the controller?
 - 1) No. There is an open in the wiring from the controller output. Correct wiring and reconnect the wires to the terminals on the signal conditioner. Be sure the ground wire from the controller output terminal is connected to the signal conditioner's negative terminal.
 - 2) Yes. Continue.
4. Is there 24VAC on the signal conditioner power terminals?
 - a. No. Determine cause and rectify.
 - b. Yes. Continue.
5. Is there twice the DC voltage on the signal conditioner's output terminals as there is on the signal conditioner's input terminals?
 - a. No. Replace the signal conditioner.
 - b. Yes. Continue.
6. Is the DC voltage on the modulating valve terminals the same as the DC voltage on the signal conditioner's output terminals?
 - a. No. There is a break in the wiring between the signal conditioner and the modulating valve terminals. Determine cause and rectify.
 - b. Yes. The electronics are working to this point. Continue.
7. Is there sufficient temperature rise for the amount of outside air that is being delivered to the space?
 - a. No. Follow the instructions in this manual for placing the unit in Manual damper control mode. Adjust the Manual Ventilation setpoint to 20% outside air. Is there sufficient temperature rise for the amount of outside air that is being delivered to the space?
 - 1) No. Contact the factory.
 - 2) Yes. Continue.
 - b. Yes. Continue.
8. Verify there is sufficient inlet gas pressure. Verify the modulating valve is properly adjusted. Verify the burner orifices are clear of obstruction. Contact the factory.

SOLUTION: If burner was not operating prior to shutdown (check prior alarm log)

1. Is there a prior alarm such as Safety Circuit Open, Check Airflow Switches, or Flame Failure?
 - a. Yes. See the Diagnostic section for the previous alarm.
 - b. No. Continue.
2. Is the room air (Room Temp) displayed on the *BACview*, reading 150°F or more?
 - a. Yes. The sensor circuit or the sensor itself is shorted. Unplug the input jack from the AdaptAire controller. Did the display change to -40°F or less?
 - 1) No. There is a short in the controller input. Replace the controller.
 - 2) Yes. Disconnect the sensor wiring at the sensor. Connect an ohmmeter to the sensor. If it is shorted replace the sensor. At

77°F the resistance should be 10KΩ. See thermistor output curve for other temperatures. If it is not shorted, there is a short in the wiring between the sensor and the input plug. Determine cause and rectify. Refer to Appendix A for a typical 10KΩ thermistor output curve.

- b. No. Continue.
3. Is the discharge air temperature (DA Temp), displayed on the *BACview*, reading -40°F or less?
 - a. Yes. The discharge air temperature sensor circuit or the sensor itself is open. Jumper the input for the sensor. Did the display change to 150°F or more?
 - 1) No. There is an open in the controller input. Replace the controller.
 - 2) Yes. Disconnect the discharge air temperature sensor wiring at the sensor. Connect an ohmmeter to the sensor. If it is open replace the sensor. At 77°F the resistance should be 10KΩ. See thermistor output curve for other temperatures. If it is not open, there is a break in the wiring between the sensor and the input plug. Determine cause and rectify.
 - b. No. Continue
4. Reset the alarm. Check and note the DC voltage at output for the gas valve modulation. Set the Heating Occupied and Night Setback Setpoints for 130°F. Set the Heating Minimum and Maximum DA Temp Setpoints for 130°F. Did the Burner VDC, displayed on the *BACview*, increase?
 - a. No. Unless the outside air temperature is extremely warm the Burner VDC should have increased to 7.5VDC or more. Close the manual main gas valve closest to the burner and measure the discharge air temperature. Is it less than 130°F?
 - 1) Yes. There is a problem with the controller program or controller itself. Contact the factory.
 - 2) No. The outside air temperature is too hot to determine the actual cause of the problem. Reset the alarm and recheck when the outside air temperature is much cooler.
 - b. Yes. This signal is fed to the signal conditioner. Disconnect the wires from the signal conditioner's input signal terminals and measure the voltage on the wires. Is it the same as the voltage coming from the controller?
 - 1) No. There is an open in the wiring from the controller output. Correct wiring and reconnect the wires to the terminals on the signal conditioner. Be sure the wire from the controller's ground terminal is connected to the signal conditioner's ground terminal.
 - 2) Yes. Continue.
5. Is there 24VAC on the signal conditioner power terminals?
 - a. No. Determine cause and rectify.
 - b. Yes. Continue.
6. Is there twice the DC voltage on the signal conditioner's output terminals as there is on the signal conditioner's input terminals?
 - a. No. Replace the signal conditioner.
 - b. Yes. Continue.

7. Is the DC voltage on the modulating valve terminals the same as the DC voltage on the signal conditioner's output terminals?
 - a. No. There is a break in the wiring between the signal conditioner and the modulating valve terminals. Determine cause and rectify.
 - b. Yes. The electronics are working to this point. Continue.
8. Is there sufficient temperature rise for the amount of outside air that is being delivered to the space?
 - a. No. Follow the instructions in this manual for placing the unit in Manual damper control mode. Adjust the Man. Vent setpoint to 20% outside air. Is there sufficient temperature rise for the amount of outside air that is being delivered to the space?
 - 1) No. Contact the factory.
 - 2) Yes. Continue.
 - b. Yes. Continue.
9. Verify there is sufficient inlet gas pressure. Verify the modulating valve is properly adjusted. Verify the burner orifices are clear of obstruction. Contact the factory.

ALARM CODE: *Burner Hand*

PROBLEM: The controller has not activated the burner enable output, but the burner status input is receiving a signal that the burner is on.

SOLUTION: **Inspect burner control circuit. This alarm has the potential to be a very serious problem. Close the manual gas valves immediately if the fan is not running.**

1. Is the controller's burner enable output LED lit?
 - a. Yes. Close manual gas valves. There is a problem with the controller program. Contact factory.
 - b. No. Continue.
2. Are the main automatic gas shutoff valves energized?
 - a. No. The main automatic gas shutoff valves are leaking. Turn off unit and close manual gas valves. Determine cause of valve failure and rectify.
 - b. Yes. Continue.
3. Is the flame relay energized?
 - a. No. There is a short in the wiring of the gas valves. Close manual gas valves. Determine cause of short and rectify.
 - b. Yes. Continue.
4. Is the burner enable relay energized?
 - a. Yes. There is a short in the wiring of the flame relay. Close manual gas valves. Determine cause of short and rectify.
 - b. No. Continue.
5. Is the burner enable relay's normally open contact closed?
 - a. Yes. Close manual gas valves. Replace the relay.
 - b. No. Continue.
6. Unplug the input terminals from the input jack. Is there continuity at the controller between the burner status terminals?
 - a. No. Close manual gas valves. There is a short in the wiring between the burner status relay and the burner status terminals. Determine cause and rectify.
 - b. Yes. Close manual gas valves. Replace the controller.

ALARM CODE: Flame Failure

This alarm code is not applicable to all unit types. The Flame Failure alarm resets automatically once the problem that generated the alarm has been rectified.

PROBLEM: The controller has received a signal from the flame relay indicating a flame failure.

SOLUTION: Investigate flame relay

1. Is there a prior alarm such as Unit On/Fan Off, Check Airflow Switches, or Safety Circuit Open?
 - a. Yes. See the Diagnostic section for the previous alarm.
 - b. No. Continue.
2. See flame relay troubleshooting information in unit *Installation, Operation, and Maintenance Manual*.

Diagnosics – Non-Critical Alarm Codes

This section should assist the user in troubleshooting non-critical alarm code messages that have been displayed on the *BACview*. Most of these alarms are automatically reset once the alarm is corrected or condition changes. Exceptions to this rule are noted in the alarm problem descriptions that follow.

ALARM CODE: Unit Off/Fan On

PROBLEM: The controller has not activated the unit enable output to start the fan, but the fan status input, is receiving a signal that the fan is running. This alarm will automatically clear about 15 seconds after the alarm is corrected.

SOLUTION: If fan is running

1. Is controller unit enable output LED for lit?
 - a. Yes. There is a problem with the controller program. Call factory.
 - b. No. Continue.
2. Is controller output contact for the unit enable output closed?
 - a. Yes. Turn off the power to the controller and recheck. If contact is still closed the controller output is shorted. Replace the controller.
 - b. No. Continue.
3. Is the unit enable relay energized?
 - a. Yes. There is a short or jumper in the wiring. Determine cause and rectify.
 - b. No. Continue.
4. Is motor starter energized?
 - a. Yes. There is a short or jumper in the wiring. Determine cause and rectify.
 - b. No. Continue.
5. Is the fan status relay energized?
 - a. Yes. There is a short or jumper in the wiring. Determine cause and rectify.
 - b. No. Continue.
6. Is the fan status relay's normally open contact, closed?
 - a. Yes. Replace relay.
 - b. No. Continue.
7. Is there continuity between at the controller between the fan status terminals?

- a. Yes. There is a short in the wiring between these terminals. Determine cause and rectify.
- b. No. Replace controller.

SOLUTION: If fan is not running

1. Is the fan status relay's normally open contact, closed?
 - a. Yes. Replace relay.
 - b. No. Continue.
2. Is there approximately 5VDC at both controller terminals used for the fan status?
 - a. Yes. There is a short in the wiring between these terminals. Determine cause and rectify.
 - b. No. Replace controller.

ALARM CODE: Unit On/Fan Off

PROBLEM: The controller has activated the unit enable output to start the fan, but the fan status input, is not receiving a signal that the fan is running. This alarm will automatically clear about 60 seconds after the alarm is corrected. Turning the unit off and then on will clear this alarm at any time.

SOLUTION: If fan/motor is running

1. Is the *BACview* indicating an alarm?
 - a. Yes. Check previous alarms and continue.
 - b. No. Continue.
2. Is the motor starter's normally open auxiliary contact, closed?
 - a. No. Replace contact.
 - b. Yes. Continue.
3. Are the high and low velocity airflow switch contacts, closed?
 - a. No. Are the belts on and is the fan motor.
 - 1) Yes. Contact factory. Do not adjust the switches setpoints.
 - 2) No. Determine cause and rectify.
 - b. Yes. Continue.
4. Is the fan status relay energized?
 - a. No. There is an open or break in the wiring. Determine cause and rectify.
 - b. Yes. Continue.
5. Is the fan status relay's normally open auxiliary contact, closed?
 - a. No. Replace relay.
 - b. Yes. Continue.
6. Is there continuity at the controller between the fan status terminals?
 - a. No. There is an open in the wiring between these terminals. Determine cause and rectify.
 - b. Yes. Replace controller.

SOLUTION: If fan/motor is not running

1. Is the *BACview* indicating an alarm?
 - a. Yes. Check previous alarms and continue.
 - b. No. Continue.
2. Is controller output LED for the unit enable output lit?
 - a. No. There is a problem with the controller. Replace controller.
 - b. Yes. Continue.
3. Is the unit enable relay energized?

- a. No. There is an open in the wiring between these terminals. Determine cause and rectify.
 - b. Yes. Continue.
4. Is the unit enable relay's normally open contact, closed?
 - a. No. Replace relay.
 - b. Yes. Continue.
5. Is the motor overload relay tripped?
 - a. Yes. Determine cause, rectify and reset.
 - b. No. Continue.
6. Is the motor starter energized?
 - a. No. There is an open or break in the wiring. Determine cause and rectify.
 - b. Yes. Check motor and motor wiring.

ALARM CODE: Check Airflow Switches

PROBLEM: The controller has activated the unit enable output to start the fan, and detected that the fan is running from a signal at the fan status input. Subsequently, the controller has detected several short momentary openings of the fan status input. The momentary openings must occur at least 4 times within 15 seconds. This alarm requires the operator to correct the condition and manually reset the alarm before normal unit operation resumes.

SOLUTION: If high airflow switch is opening. Do not adjust the switch setpoints

1. Are all of the filters in place?
 - a. No. Install filters and continue.
 - b. Yes. Continue.
2. Does the external static pressure match that listed on the rating plate?
 - a. No. Verify all associated ductwork is installed and continue.
 - b. Yes. Continue.
3. Does the fan RPM match that listed on the Spec. Sheet?
 - a. No. Correct to reduced fan speed and continue.
 - b. Yes. Continue.
4. Are the airflow switches' sensing tubes obstructed?
 - a. Yes. Clear and continue.
 - b. No. Continue.
5. Contact factory.

SOLUTION: If low airflow switch is opening. Do not adjust the switch setpoints

1. Does low airflow switch open when the burner is off
 - a. No. Disconnect both pressure sensing tubes from one of the airflow switches and measure the differential pressure by connecting the high sensing port of a manometer to one of the airflow sensing tubes and the low sensing port to the other. Is the differential pressure approximately the midpoint between the high and low airflow switch setpoints?
 - 1) No. Close the profile opening until the differential pressure is approximately the midpoint between the high and low airflow switch setpoints. Reconnect the sensing tubes, restart the burner, and verify the airflow switch remains closed when the burner is at the maximum rated input. Continue.
 - 2) Yes. Continue.
2. Are all of the filters dirty?

- a. Yes. Install clean filters and continue.
- b. No. Continue.
3. Does the external static pressure match that listed on the rating plate?
 - a. No. Verify all associated ductwork is installed as designed, and there are no obstructions. Continue.
 - b. Yes. Continue.
4. Does the fan RPM match that listed on the Spec. Sheet?
 - a. No. Correct to increased fan speed and continue.
 - b. Yes. Continue.
5. Are the airflow switches' sensing tubes obstructed?
 - a. Yes. Clear and continue.
 - b. No. Continue.
6. Contact factory.

ALARM CODE: *Clogged Filters*

PROBLEM: The filter air pressure switch has closed between the appropriate terminals on the unit's terminal strip located in the unit's main control panel indicating a clogged filter. See the Typical Wiring Schematic, Multiplexed Input, and Clogged Filter sections of this manual for more information. This alarm will automatically clear about 5 seconds after the problem is corrected.

SOLUTION: If clogged filter switch is closing.

1. Are the filters dirty?
 - a. Yes. Install clean filters and continue.
 - b. No. Continue.
2. Are the airflow switch sensing tubes obstructed?
 - a. Yes. Clear and continue.
 - b. No. Continue.
3. Is the airflow switch setpoint properly adjusted?
 - a. No. Adjust setpoint.
 - b. Yes. Continue.
4. Are the wires connected to the air pressure switch's normally open contact?
 - a. No. Rewire switch and continue.
 - b. Yes. Continue.
5. Is the air pressure switch's normally open contact open?
 - a. No. Disconnect the sensing tubes and recheck. Replace the switch if contacts do not open.
 - b. Yes. Continue.
6. Find the clogged filter switch on the electrical schematic and identify the control panel terminals to which it is connected. Disconnect the wire from these terminals. Does this clear the alarm?
 - a. Yes. There is short in the wiring between the terminal strip and the switch. Determine cause and rectify.
 - b. No. Continue.
7. Unplug the connector from the controller that is connected to the multiplexed input. Does this clear the alarm?
 - a. Yes. There is short in the wiring of the multiplexed resistors. Determine cause and rectify.
 - b. No. There is an internal short in the controller. Replace the controller.

ALARM CODE: Safety Circuit Open

PROBLEM: The controller has detected a failure in the safety circuit. This alarm does not disable the burner and does not affect actual operation of the unit in any way. It merely provides status information to the user indicating that the safety circuit tripped. Though the condition may have already been rectified automatically, the alarm must be manually reset in order to be cleared from the system. Requiring the manual reset gives the user the ability to know that the alarm occurred at some previous time should they wish to further investigate the situation. See the Unit Resets section of this manual for information on how to manually reset the alarm.

SOLUTION: If fan is not running (check prior alarm log)

1. Is there a prior alarm such as Unit On/Fan Off or Airflow Sw?
 - a. Yes. See the Diagnostic section for the previous alarm.
 - b. No. Continue.
2. Set Unit Mode to Manual. Did fan start?
 - a. No. See the Diagnostic section for Unit On/Fan Off.
 - b. Yes. Continue.

SOLUTION: If fan is running (check prior alarm log)

1. Is the high temperature limit tripped?
 - a. Yes. Determine cause and rectify.
 - b. No. Continue.
2. Is the low gas pressure switch closed?
 - a. No. Verify the inlet gas pressure is as specified on the gas piping diagram. **The low gas pressure switch setpoint should not be adjusted.** The inlet gas pressure must remain as specified when unit fires at full input. Correct gas pressure and reset switch. If the switch cannot be reset, replace it. See *Installation, Operation and Maintenance Manual* for more information.
 - b. Yes. Continue.
3. Is the high gas pressure switch closed?
 - a. No. Verify the firing rate pressure at full input is as specified on the unit rating plate. **The high gas pressure switch setpoint should not be adjusted.** The firing rate pressure must remain as specified when unit fires at full input. Correct gas pressure and reset switch. If the switch cannot be reset, replace it. See *Installation, Operation and Maintenance Manual* for more information.
 - b. Yes. Continue.
4. Is the safety circuit relay energized?
 - a. No. Check for loose wiring and rectify.
 - b. Yes. Continue.
5. Is the safety circuit relay's normally open contact closed?
 - a. No. Replace the relay.
 - b. Yes. Continue.
6. Is there continuity at the controller between the safety status terminals?
 - c. No. There is an open in the wiring between these terminals. Determine cause and rectify.
 - d. Yes. Replace controller.

ALARM CODE: *Burner Status Alert*

PROBLEM: The controller has activated the burner enable output, but the burner status input is not receiving a signal that the burner is on.

SOLUTION: Inspect burner control circuit and burner

1. Is there a prior alarm such as Unit On/Fan Off, Check Airflow Switches, or Safety Circuit Open?
 - a. Yes. See the Diagnostic section for the previous alarm.
 - b. No. Continue.
2. Is the burner enable relay energized?
 - a. No. There is an open in the 24VAC circuit. Determine cause and rectify.
 - b. Yes. Continue.
3. Is the burner enable relay's normally open contact closed?
 - a. No. Replace relay.
 - b. Yes. Continue.
4. Is there a pilot flame present?
 - a. No. Refer to the *Installation, Operation and Maintenance Manual* for guidance in troubleshooting the flame relay or ignition module.
 - b. Yes. Continue.
5. Is the flame relay or ignition module main valve terminal energized?
 - a. No. Refer to the *Installation, Operation and Maintenance Manual* for guidance in troubleshooting the flame relay or ignition module.
 - b. Yes. Continue.
6. Is the gas valve/burner status relay energized?
 - a. No. There is an open in the main valve control circuit. Determine cause and rectify.
 - b. Yes. Continue.
7. Is the gas valve/burner status relay's normally open contact closed?
 - a. No. Replace relay.
 - b. Yes. Continue.
8. Is there continuity at the controller between the burner status terminals?
 - a. No. There is an open in the wiring between these terminals. Determine cause and rectify.
 - b. Yes. Replace controller.

ALARM CODE: *Insufficient Outside Air*

PROBLEM: The controller has turned off the burner enable output because the percentage of outside air has dropped below 20% for more than five minutes, and the unit is in the Heating mode. This alarm will automatically clear about 5 seconds after the alarm is corrected.

SOLUTION: If heat is desired

1. Are the outside air hood filters or bird screen or any associated outside air ductwork obstructed?
 - a. Yes. Clear obstruction or change filters.
 - b. No. Continue.
2. Are the outside air and return air dampers and actuators working properly?

- a. Yes. Continue.
 - b. No. Make necessary adjustments and force the unit to recalibrate. See Calibrate in the Resets Section of this manual.
3. Are the flow measuring station pitot tubes and pressure tubing clear?
 - a. Yes. Continue.
 - b. No. Clean and force the unit to recalibrate. See Calibrate in the Resets Section of this manual.
4. Do the dampers track with a change in the %OA setpoint? The dampers utilized on the unit are not linear with respect to airflow and openness, and as such, the proportion of outside air damper movement will not be exactly equal to the %OA setpoint. However, at 20% OA the dampers should be approximately ½” open.
 - a. Yes. Continue.
 - b. No. Check the damper motor and linkage connections. When 24VAC is powering the damper actuator and the control signal is 0VDC, the outside air damper should be close to a “rattle tight” position and the return air damper should be open. If the 24VAC power is removed, the actuator will draw the outside air damper tightly closed and the return air damper tightly open. When 24VAC is powering the damper actuator and the control signal is 10VDC, the outside air damper should be fully open and the return air damper should be closed.
5. Is there approximately 24VAC at the COM and EXC terminals on the airflow station pressure transducer?
 - a. Yes. Continue.
 - b. No. Is there 120VAC on the primary side of the low voltage transformer and 24VAC volt at the transformer secondary?
 - 1) Yes. There is an open in the wiring between the transformer and the transducer. Locate the wiring problem and rectify.
 - 2) No. If there is 120VAC on the primary and 0VAC on the secondary, replace the transformer. If there is 0VAC on the primary, there is an open in the wiring supplying power to the transformer. Locate the wiring problem and rectify.
6. Remove both of the plastic tubes from the airflow station pressure transducer and gently blow into the HIGH side port. **Caution: The transducer is extremely sensitive. Blowing too hard into the sensing tube may damage the transducer.** Is there approximately 5VDC across the COM and OUT terminals of the pressure transducer?
 - a. Yes. Continue.
 - b. No. The pressure transducer is defective. Replace it.
7. Remove both of the plastic tubes from the airflow station pressure transducer and gently blow into the HIGH side port. **Caution: The transducer is extremely sensitive. Blowing too hard into the sensing tube may damage the transducer.** Is there approximately 5VDC across the controller input terminals that are connected to the transducer?
 - a. Yes. There is a problem with the controller. Replace it.
 - b. No. There is an open in the wiring between these pressure transducer and the AdaptAire controller terminals. Locate and rectify.

SOLUTION: If less outside air is desired

1. Is heat required?
 - a. Yes. The AdaptAire control system must be in the Heating mode. In this mode the smallest allowable amount of outside air is 20%. Verify

the system is in the Heating mode and the MIN VENT SP is set for 20%. See Heating/Cooling Mode and Minimum Ventilation Sections of this manual.

- b. No. Continue.
2. Is cooling or ventilation required?
 - a. Yes. The AdaptAire control system must be in the Ventilation/Cooling mode. In this mode the smallest allowable amount of outside air is 0%. Verify the system is in the Cooling mode and the MIN VENT SP is set for the desired percent of outside air. See Heating/Ventilating/Cooling Mode and Minimum Ventilation Sections of this manual.
 - b. No. Contact factory.

ALARM CODE: Room Sensor Failure

PROBLEM: The unit is configured for MRT or MRT-Expert control and communications between the room sensor and the unit control module have failed. This alarm will automatically clear after the alarm is corrected.

SOLUTION: Investigate room sensor

1. When room sensor communications are interrupted, the displayed room temperature will be equal to the last good temperature reading received from the room sensor for approximately 5 minutes following the interruption. For example, if the room temperature was 67°F when the room sensor was disconnected, the displayed room temperature will be 67°F for approximately 5 minutes. After this period has elapsed, the unit will default to a failsafe mode during which the discharge air temperature will be maintained at 70°F. The displayed room temperature on the *BACview* will be 45°F. If the unit control module then loses power any time after the loss of communications and is repowered, the room temperature will be displayed as 0°F until the communications failure is rectified. Is the room sensor wired correctly and securely in the terminal connectors on the back of the room sensor as well as at the Rnet input on the left side of the unit control module?
 - a. No. Correct wiring and securely tighten connections. Check to see if the alarm has turned off, indicating the problem has been resolved.
 - b. Yes. Internal room sensor failure. Replace room sensor.

ALARM CODE: Invalid Damper Control Mode

PROBLEM: The user has selected Mixed Air Temperature control mode for damper operation and the unit is configured for MDT or MDT-Expert control, *or* communications between the room sensor and the unit control module have failed during MRT-Expert control. This alarm will automatically clear after the alarm is corrected.

SOLUTION: If the unit is configured for MRT or MRT-Expert controls

1. Is the room sensor wired correctly and securely in the terminal connectors located on the back of the room sensor as well as at the Rnet input on the left side of the unit control module?
 - a. No. Correct wiring and securely tighten connections.
 - b. Yes. Internal room sensor failure. Replace room sensor.

SOLUTION: If the unit is configured for MDT or MDT-Expert controls

1. Select either the Manual or Building Pressure damper control modes. Mixed Air Temperature control mode is incompatible with MDT and MDT-Expert control systems. Mixed Air Temperature control mode requires that the unit

be configured for MRT or MRT-Expert controls and that a room sensor be installed and functioning.

ALARM CODE: Monthly/Quarterly/Yearly
Maintenance Reminder (See IOM)

PROBLEM: The controller has determined that based on unit runtime, the operator should perform monthly, quarterly, or yearly maintenance functions as outlined in the unit's *Installation, Operation, and Maintenance* (IOM) manual. This alarm does not indicate an actual fault or issue with the unit operation and merely serves as a reminder that the unit should be inspected and any relevant maintenance functions should be performed to continue to ensure successful operation of the unit.

SOLUTION: **If an active maintenance reminder alarm is present:**

1. Perform monthly, quarterly, or yearly maintenance functions as indicated in the unit's IOM.
2. Use the Alarms Reset function on the *BACview* to reset the alarm.

Glossary

BACview – A four line by forty character display used to change setpoints and monitor the unit's operation. See *BACview*.

Equivalent temperature rise – Simply stated this value is the actual temperature rise generated by the unit at any given time. More precisely stated, it is the quantity of outside air raised to the discharge air temperature, plus, the quantity of return air raised to the discharge air temperature. It is equivalent to the heat actually delivered to the space. The purpose for this in the burner control scheme is to limit the burner's firing rate, based on the percentage of outside air, and thus the carbon monoxide generated by the unit.

Expressed mathematically it is: $T_{eq} = \%OA (T_{da} - T_{oa}) + \%RA (T_{da} - T_{ra})$

PID Control or loop – Proportional, Integral, Derivative control, a common control scheme used in modulating HVAC systems.

Remote Control Panel – The remote control panel is a cover plate with one or more of the following controls and indicators: unit enable/remote temperature setpoint pot, remote damper control pot, speed control switch, fill/drain switch, fan on, clogged filter, high speed, low speed, burner on, cool on lights. This cover plate fits on a standard 3 gang electrical switch box.

WebCTRL – A web based graphical user interface, which provides the user access to the unit via the internet.

Appendix A

10K Ω Thermistor Output Curve

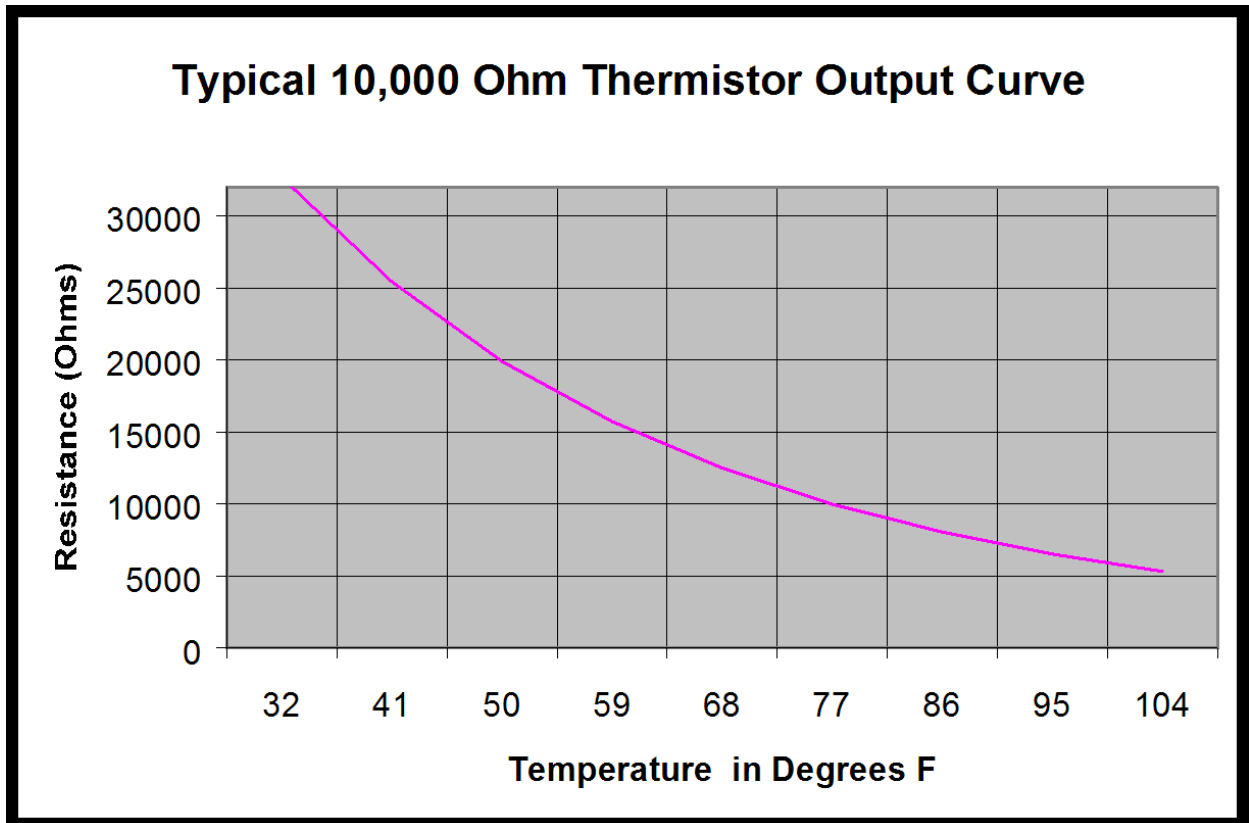
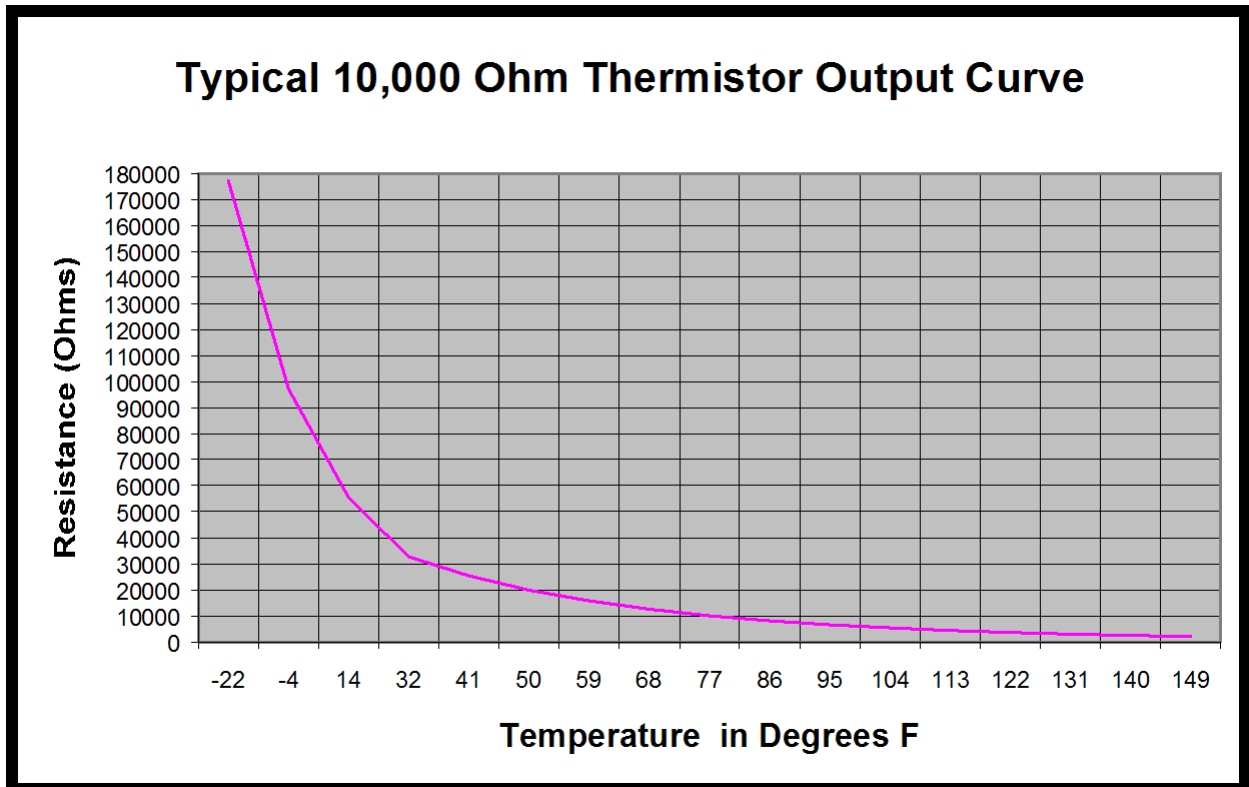

Appendix B

Airflow Station Layout

AIRFLOW STATION LAYOUT

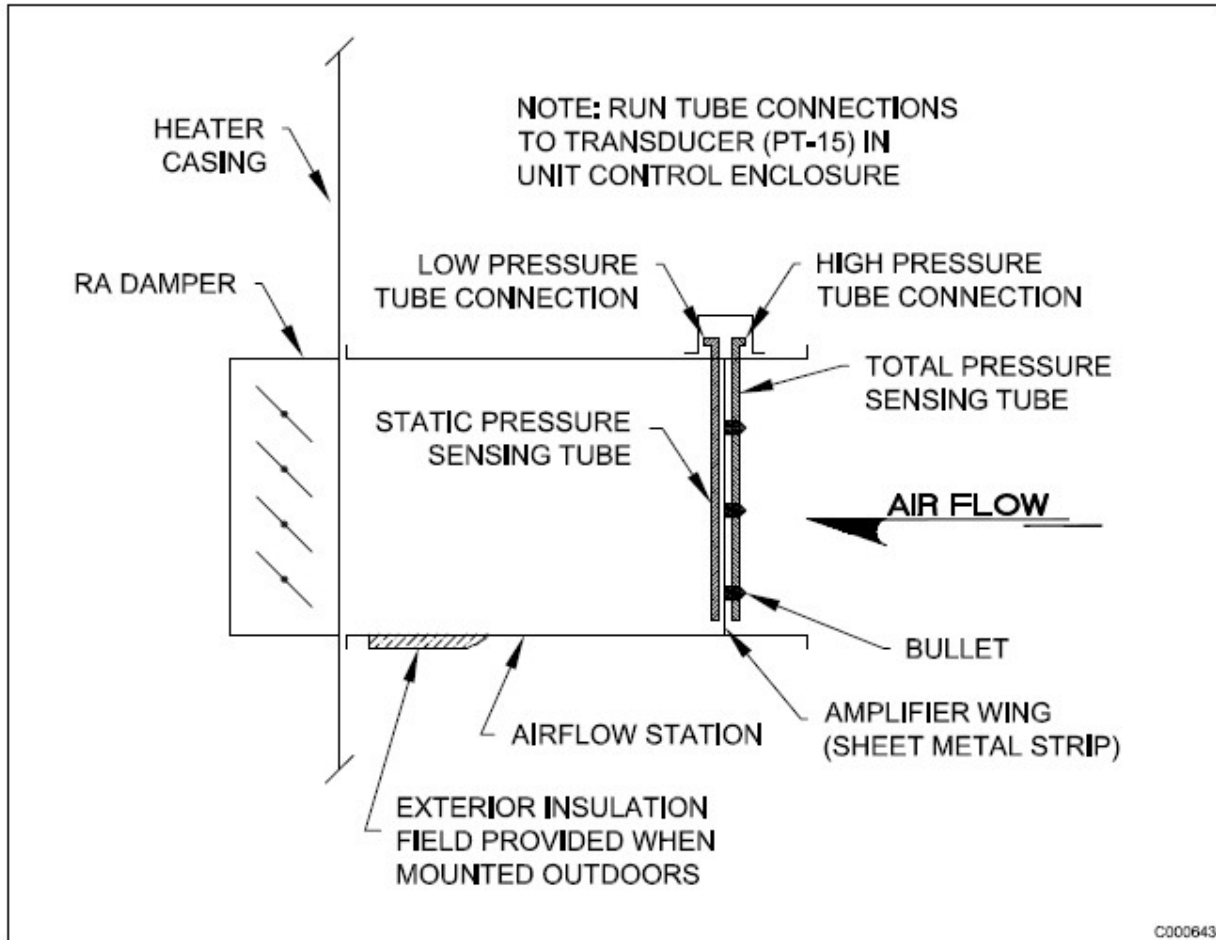

Appendix C

I/O Zone 583 Controller Specifications

POWER REQUIREMENTS

24VAC \pm 10%, 20VA

NETWORK COMMUNICATION

BACnet (ARCNET and MS/TP), Modbus RTU, or N2 bus at up to 76.8K baud or 156K baud over ARCnet. LonWorks and Ethernet using plug-in communications board.

USER INTERFACE

MRT-Expert: modulating room temperature control with intelligent room sensor and *BACview* control panel.

MDT-Expert: modulating discharge temperature control with *BACview* control panel.

MEMORY

1 MB non-volatile battery-backed RAM, 4 MB flash memory, 16-bit memory bus

REALTIME CLOCK

Battery-backed to keep time in event of power failure.

TEMPERATURE OPERATING RANGE

0°F to 130°F, 10% to 95% RH non-condensing

INPUTS/OUTPUTS

8 Universal Inputs

- Inputs 1 & 2
 - Dry, thermistor, 0-5VDC
- Inputs 3 – 6
 - Dry, thermistor
- Inputs 7 & 8
 - 1k – 10k pot

5 Digital Outputs

- Relay contacts rated at 1A Resistive @ 24VAC/VDC
- LED indication

3 Analog Outputs

- 0 – 10 VDC

OUTPUT ASSIGNMENTS - ANALOG

AO1 Burner gas firing rate 0 – 10 VDC

AO2 RA or Mixing Damper Control/ User Configured 0 – 10VDC

AO3 Burner gas firing rate

OUTPUT ASSIGNMENTS - DIGITAL

DO1 Unit Enable

DO2 Burner Enable

DO3 Stg 1 Cooling Enable

DO4 Stg 2 Cooling Enable

DO5 Pilot to Main Flame Sensor Changeover Switch

INPUT ASSIGNMENTS - UNIVERSAL

IN1 Pressure Transducer for Building Pressure Control or User Configured

IN2 Pressure Transducer for Flow Station

IN3 Multiplexed

- 100% Outside Air/100% Output
- Flame Failure Alarm
- Safety Circuit Status
- Manual/Mixed Air Dmpr Control

IN4 Multiplexed

- Auxiliary Unit Enable
- Clogged Filter
- Fan Status
- Burner Status

IN5 Outside Air sensor

IN6 Discharge Air sensor

IN7 Unit Enable/Remote Setpoint

IN8 Damper Control

RNET Room Air sensor

Appendix D

I/O Zone 583 Controller Battery Checkout

The battery on the unit control module retains the controller's memory in the event of power failure. The 10-year Lithium CR2032 battery provides a minimum of 10,000 hours of data retention during power outages. Remember to check the battery periodically (once a month) to verify that its voltage is approximately 3 VDC.

If the voltage is not at least 3 VDC, replace the battery so that the controller's program is not lost during a power outage. Loss of the program will require the controller to be shipped back to the factory for reprogramming because the unit will not function without the program.

Make sure the controller is powered any time the battery is removed or the controller's memory may be lost.

Figure 5 shows the location of the battery on the controller.

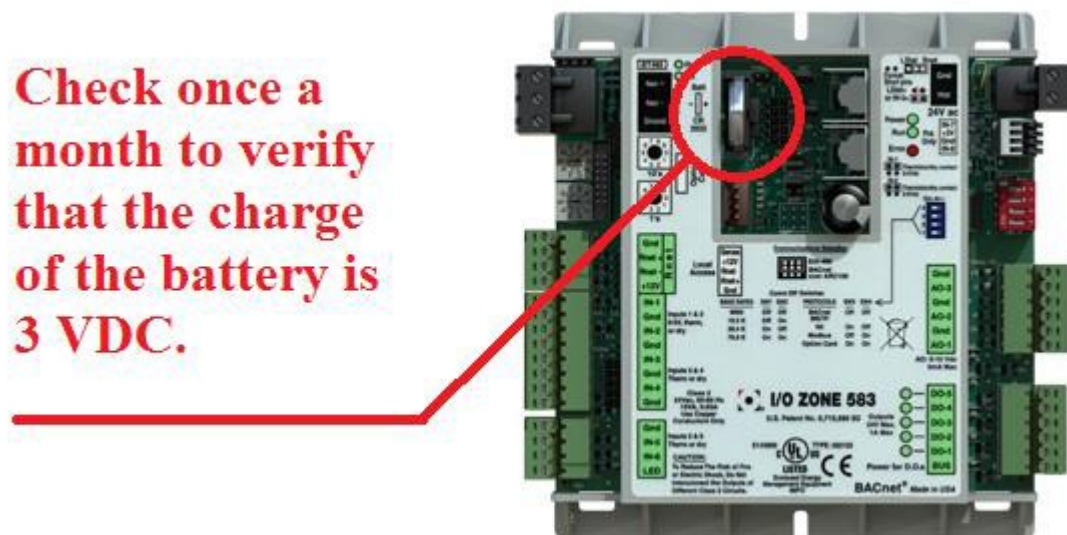

Figure 5

Appendix E

I/O Flex 6126 Controller Specifications

POWER REQUIREMENTS

24VAC \pm 10%, 20VA

NETWORK COMMUNICATION

BACnet (ARCNET and MS/TP), Modbus RTU, or N2 bus at up to 76.8K baud or 156K baud over ARCnet. LonWorks and Ethernet using plug-in communications board.

USER INTERFACE

MRT-Expert: modulating room temperature control with intelligent room sensor and *BACview* control panel.

MDT-Expert: modulating discharge temperature control with *BACview* control panel.

MEMORY

1 MB non-volatile battery-backed RAM, 4 MB flash memory, 16-bit memory bus

REALTIME CLOCK

Battery-backed to keep time in event of power failure.

TEMPERATURE OPERATING RANGE

-20°F to 140°F, 10% to 95% RH non-condensing

INPUTS/OUTPUTS

12 Universal Inputs

- Inputs 1-12
 - Dry, thermistor, 0-5VDC
- Inputs 1 & 2
 - Pulse counting

6 Digital Outputs

- Relay contacts rated at 5A Resistive @ 250VAC
- LED indication

6 Analog Outputs

- Outputs 1-6
 - 0-10 VDC
- Outputs 1 & 2
 - 4-20 mA

OUTPUT ASSIGNMENTS - ANALOG

AO1 Burner gas firing rate 0 – 10 VDC
AO2 User Configured 0 – 10VDC
AO3 Burner air control 0 – 10 VDC
AO4 Unassigned
AO5 Unassigned
AO6 Unassigned

OUTPUT ASSIGNMENTS - DIGITAL

DO1 Unit Enable
DO2 Burner Enable
DO3 Stg 1 Cooling Enable
DO4 Stg 2 Cooling Enable
DO5 Stg 3 Cooling Enable
DO6 Stg 4 Cooling Enable

INPUT ASSIGNMENTS - UNIVERSAL

IN1 Outside/Inlet Air Sensor
IN2 Discharge Air Sensor
IN3 Auxiliary Unit Enable
IN4 100% Outside Air Switch
IN5 Fan Status
IN6 Clogged Filter Status
IN7 Safety Circuit Status
IN8 Burner Status
IN9 Flame Failure
IN10 User Input
IN11 Unassigned
IN12 Unassigned

RNET Room Air sensor

Appendix F

I/O Flex 6126 Controller Battery Checkout

The battery on the unit control module retains the controller's memory in the event of power failure. The 10-year Lithium CR2032 battery provides a minimum of 10,000 hours of data retention during power outages. Remember to check the battery periodically (once a month) to verify that its voltage is approximately 3 VDC.

If the voltage is not at least 3 VDC, replace the battery so that the controller's program is not lost during a power outage. Loss of the program will require the controller to be shipped back to the factory for reprogramming because the unit will not function without the program.

Make sure the controller is powered any time the battery is removed or the controller's memory may be lost.

Figure 5 shows the location of the battery on the controller.

Check once a month to verify that the charge of the battery is 3 VDC.

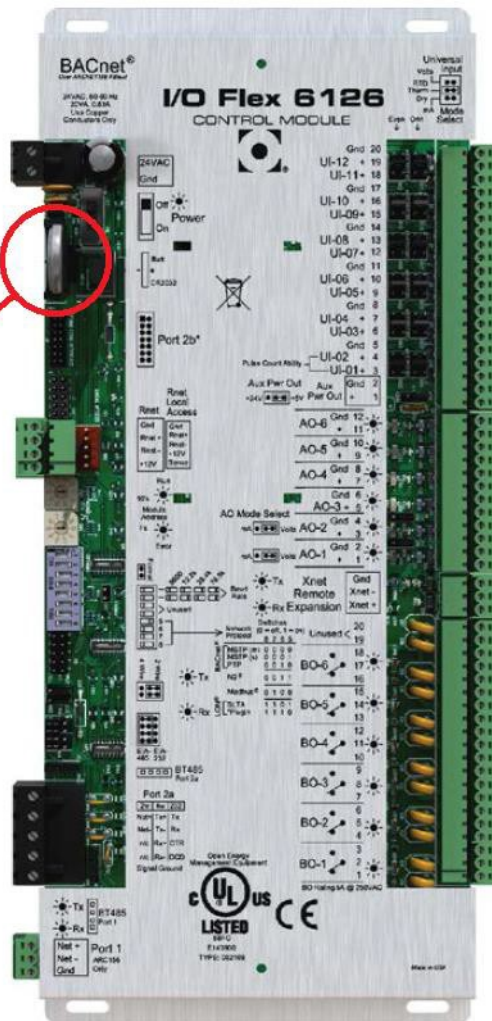

Figure 5

Appendix G

Control System Field Conversion

The unit can be converted to a different control system in the field. Locate the unit's current control system in the "From" column and the new control system in the "To" column that is in the same row as the current control system. Follow the steps outlined in the "New" column to complete the field conversion.

NOTE: Contact the factory for the *BACview* Admin password if required and to have the wiring diagram updated when doing a control system field conversion. Failure to do so will result in inaccurate documentation that can complicate possible future troubleshooting efforts.

From	To
<i>MRT</i>	<p><i>MDT</i></p> <ol style="list-style-type: none"> 1. Order a <i>BACview</i> remote panel from the factory and plug it into the local access connection on the front of the unit control module. 2. Change the Control System parameter on Unit Modes screen of <i>BACview</i> to MDT.
	<p><i>MRT-Expert</i></p> <ol style="list-style-type: none"> 1. Order a <i>BACview</i> remote panel from the factory and plug it into the local access connection on the front of the unit control module. Leave the room sensor connected. 2. Disconnect the unit enable potentiometer from terminals 214, 215, and 216 and place a jumper between terminals 213 and 216 on the main terminal strip.
	<p><i>MDT-Expert</i></p> <ol style="list-style-type: none"> 1. Order a <i>BACview</i> remote panel from the factory and plug it into the local access connection on the front of the unit control module. 2. Disconnect the unit enable potentiometer from terminals 214, 215, and 216 and place a jumper between terminals 213 and 216 on the main terminal strip. 3. Change the Control System parameter on Unit Modes screen of <i>BACview</i> to MDT.
<i>MDT</i>	<p><i>MRT</i></p> <ol style="list-style-type: none"> 1. Order a <i>BACview</i> remote panel and a room sensor from the factory. 2. Plug the <i>BACview</i> into the local access connection on the front of the unit control module. 3. Wire the room sensor into the four-wire Rnet input on the left side of the unit control module. 4. Change the Control System parameter on Unit Modes screen of <i>BACview</i> to MRT.
	<p><i>MRT-Expert</i></p> <ol style="list-style-type: none"> 1. Order a <i>BACview</i> remote panel and a room sensor from the factory. 2. Disconnect the unit enable potentiometer from terminals 214, 215, and 216 and place a jumper between terminals 213 and 216 on the main terminal strip. 3. Plug the <i>BACview</i> into the local access connection on the front of the unit control module.

From	To
MDT (cont.)	<p><i>MRT-Expert (continued)</i></p> <ol style="list-style-type: none"> 4. Wire the room sensor into the four-wire Rnet input on the left side of the unit control module. 5. Change the Control System parameter on Unit Modes screen of <i>BACview</i> to MRT.
	<p><i>MDT-Expert</i></p> <ol style="list-style-type: none"> 1. Order a <i>BACview</i> remote panel from the factory and plug it into the local access connection on the front of the unit control module. 2. Disconnect the unit enable potentiometer from terminals 214, 215, and 216 and place a jumper between terminals 213 and 216 on the main terminal strip.
MRT- Expert	<p><i>MRT</i></p> <ol style="list-style-type: none"> 1. Remove the jumper between terminals 213 and 216 on the main terminal strip and connect the unit enable potentiometer to terminals 214, 215, and 216. 2. Disconnect the <i>BACview</i> remote panel from the local access connection on the front of the unit control module. Leave the room sensor connected.
	<p><i>MDT</i></p> <ol style="list-style-type: none"> 1. Remove the jumper between terminals 213 and 216 on the main terminal strip and connect the unit enable potentiometer to terminals 214, 215, and 216. 2. Change the Control System parameter on Unit Modes screen of <i>BACview</i> to MDT. 3. Disconnect the <i>BACview</i> remote panel from the local access connection on the front of the unit control module.
	<p><i>MDT-Expert</i></p> <ol style="list-style-type: none"> 1. Change the Control System parameter on Unit Modes screen of <i>BACview</i> to MDT.
MDT- Expert	<p><i>MRT</i></p> <ol style="list-style-type: none"> 1. Remove the jumper between terminals 213 and 216 on the main terminal strip and connect the unit enable potentiometer to terminals 214, 215, and 216. 2. Change the Control System parameter on Unit Modes screen of <i>BACview</i> to MRT. 3. Disconnect the <i>BACview</i> remote panel from the local access connection on the front of the unit control. 4. Order a room sensor from the factory and wire it into the four-wire Rnet input on the left side of the unit control module.
	<p><i>MDT</i></p> <ol style="list-style-type: none"> 1. Remove the jumper between terminals 213 and 216 on the main terminal strip and connect the unit enable potentiometer to terminals 214, 215, and 216. 2. Disconnect the <i>BACview</i> remote panel from the local access connection on the front of the unit control module.
	<p><i>MRT-Expert</i></p> <ol style="list-style-type: none"> 1. Order a room sensor from the factory and wire it into the four-wire Rnet input on the left side of the unit control module. 2. Change the Control System parameter on Unit Modes screen of <i>BACview</i> to MRT.

Appendix H

Room Sensor Wiring

For the room sensor wiring, use a 4 conductor shielded or unshielded plenum rated cable, 22 AWG. The wire length between the room sensor and controller must not exceed 500 feet.

If using shielded wire (recommended), terminate the shield wire to the Gnd terminal on the Rnet port at the controller together with the green wire. Do not terminate the shield wire on the room sensor side. Isolate the unterminated end of the shield wire so it does not come into contact with any other wires or conductive surfaces.

Wire each terminal on the controller's Rnet port (located on the left-hand side of the controller) to the terminal of the same name on the room sensor. The figure below is provided for reference. It does not matter if your cable's wire colors do not match this figure, as long as each terminal on the room sensor is connected to the terminal of the same name on the controller.

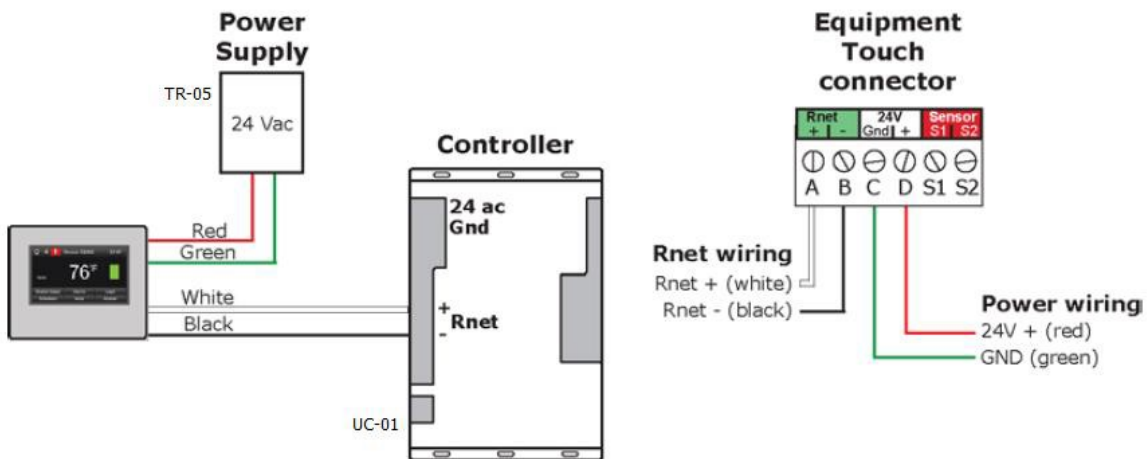



Applied Air[®]

4830 Transport Drive, Dallas, TX 75247

Phone: 214-638-6010

www.appliedair.com