



# Applied Air®

## INSTALLATION, OPERATION AND MAINTENANCE MANUAL FOR IFJ INDIRECT GAS-FIRED HEATERS

**ATTENTION: READ THIS MANUAL AND ALL LABELS ATTACHED TO THE UNIT CAREFULLY BEFORE ATTEMPTING TO INSTALL, OPERATE OR SERVICE THESE UNITS! CHECK UNIT DATA PLATE FOR TYPE OF GAS AND ELECTRICAL SPECIFICATIONS AND MAKE CERTAIN THAT THESE AGREE WITH THOSE AT POINT OF INSTALLATION. RECORD THE UNIT MODEL AND SERIAL No.(s) IN THE SPACE PROVIDED. RETAIN FOR FUTURE REFERENCE.**

### FOR YOUR SAFETY

The use and storage of gasoline or other flammable vapors and liquids in open containers in the vicinity of this appliance is hazardous.

### POUR VOTRE SÉCURITÉ

L'utilisation et l'entreposage d'essence ou d'autres liquides ou produits émettant des vapeurs inflammables dans des récipients ouverts à proximité de cet appareil est dangereux.



### FOR YOUR SAFETY

If you smell gas:

1. Open Windows
2. Don't touch electrical switches.
3. Extinguish any open flame.
4. Immediately call your gas supplier.



### POUR VOTRE SÉCURITÉ

Si vous sentez une odeur de gaz :

1. Ouvrez les fenêtres.
2. Ne pas actionner d'interrupteur.
3. Éteindre toute flamme ouverte.
4. Appelez immédiatement votre fournisseur de gaz.

**WARNING: Improper installation, adjustment, alteration, service or maintenance can cause property damage, injury or death. Read the installation, operating and maintenance instructions thoroughly before installing or servicing this equipment.**

**AVERTISSEMENT : Une installation déficiente, de même qu'un mauvais réglage, modification, entretien ou maintenance peuvent occasionner des dommages matériels, corporels voire causer la mort. Lire attentivement les instructions d'installation, d'utilisation et d'entretien avant d'installer ou d'intervenir sur cet appareil.**

### WARNING

Install, operate and maintain unit in accordance with manufacturer's instructions to avoid exposure to fuel substances or substances from incomplete combustion which can cause death or serious illness. The state of California has determined that these substances may cause cancer, birth defects, or other reproductive harm.

### INSTALLER'S RESPONSIBILITY

**Installer Please Note:** This equipment has been test fired and inspected. It has been shipped free from defects from our factory. However, during shipment and installation, problems such as loose wires, leaks or loose fasteners may occur. **It is the installer's responsibility to inspect and correct any problems that may be found.**



## SECTION I - FOREWORD

As is the case with any fine piece of equipment, care must be taken to provide the proper attention to the operation and maintenance detail of this machine.

This manual of instructions along with the burner and draft regulator IOM's has been prepared in order for you to become well-acquainted with those details, and in doing so, you will be able to give your Indirect Gas-Fired System the care and attention which any piece of equipment needs and deserves.

**It is the customer and installation personnel responsibility to determine if the unit is equipped with all of the safety devices required for the particular application. Safety considerations include the accessibility of the unit to non-service personnel, the provision of electrical lockout switches, maintenance procedures and automatic control sequences. Clearly mark any shutoff devices.**

Table of Contents	
Section I: Foreword and Table of Contents .....	2
Section II: General Information .....	3
Section III: Installation .....	4
Section IV: Pre-Start Up .....	12
Section V: Unit Start Up .....	15
Section VI: Unit Shut Down .....	18
Section VII: Troubleshooting .....	19
Section VIII: Servicing the Burner .....	44
Section IX: Maintenance Schedule and Lubrication Requirements .....	48
Section X: Replacement Parts .....	53

### \* IMPORTANT NOTICE \*

Applied Air assumes no responsibility for loss or damage in transit; therefore, you should protect yourself by following these instructions. Failure to do so is your responsibility.

#### **BILL OF LADING**

Save your bill of lading. It is a contract, and you will need it, provided you have to file a loss or damage claim. Remember, claims are outlawed after nine months.

#### **LOSS IN TRANSIT**

Before you sign for this shipment, check against the bill of lading, also the transportation company's delivery ticket. Make sure that you get the exact total of articles listed. Should the delivery ticket show more or less items than you are offered, then the carrier's agent must mark the difference on your freight bill before you sign.

#### **VISIBLE DAMAGE IN TRANSIT**

If something is damaged, accept the shipment only if the carrier's agent places a notation on your freight bill explaining the nature and extent of damage. Upon inspection of article, make claim to the delivering carrier.

#### **CONCEALED DAMAGE IN TRANSIT**

Sometimes transit damage is not noticed until the goods are unpacked. In such cases, notification to the carrier must be made within fifteen (15) days of receipt of shipment. In such cases, save the packages and packing material, then notify the transportation company at once, and request an inspection. When the inspector calls, have him make out and leave a "concealed" bad order report. He is obliged to give one to you. Insist on it.

#### **DISPOSITION OF DAMAGED ARTICLES**

Never return damaged articles to us. They are the property of the transportation company when the claim is filled. They will give you disposition instructions.

#### **PACKING**

We comply with the packing requirements of the transportation companies, and your bill of lading proved that everything was in good condition when shipped. That bill of lading contract requires them to deliver in perfect condition.

## SECTION II - GENERAL INFORMATION

### A. Purpose

The purpose of this manual is to present a guide for proper installation, maintenance, and operation of the Indirect Gas-Fired System, and supplement, **but not to replace**, the services of qualified field service personnel to supervise the initial start-up and adjustment of the unit. Persons without previous experience with large commercial and industrial heating equipment should not attempt the initial adjustment and checkout procedure, which is essential before such installations may be considered ready for operation. This manual should be made readily available to all operating personnel as an aid in troubleshooting and proper maintenance. Due to the custom nature of Applied Air equipment, not all possibilities are addressed in this manual. The customer or installer can obtain information from Applied Air's sales representative or the Applied Air factory.

**WARNING: Failure to comply with general safety information may result in extensive property damage, severe personal injury or death.**

### B. Shipping

Base Indirect Gas-Fired units are shipped completely assembled where shipping limitations allow. Optional inlet hoods, filter and /or damper sections, or other large accessories are assembled and shipped mounted and wired whenever possible within limitations of shipping and handling. Some optional accessories shipped separately may require field assembly. Any wired accessories, which have been disassembled for separate shipment, require no additional conduit or wire for field reassembly. All wire leads will be tagged for ease of reconnection in the field.

**If the heater and/or accessories cannot be installed immediately, they should be stored in a clean dry environment. If this is not possible and the heater must be stored outdoors, it should be protected from the weather with tarpaulins or plastic coverings. Rotate the fans monthly. Prior to beginning installation of a unit that has been in storage for weeks or months, the unit and its components should be closely inspected.**

Shipments are made F.O.B. Dallas, Texas by truck. The unit is securely strapped, tied, and blocked to prevent shipping damage. All shipments are checked by an inspector before they are accepted by the carrier. Parts that are shipped un-mounted are noted on the bill of lading. These parts, where feasible, are packaged and shipped with the units. Upon receipt of shipment, all units should be checked against the bill of lading to insure all items have been received. All equipment (and any optional accessories) should be checked carefully for physical damage in the presence of the carrier's representative. If parts are missing or damage has occurred, a claim should be filed immediately with the carrier.

All Indirect Gas-Fired units are given a complete operations test and control circuit checkout before shipment. Copies of the wiring diagram, piping diagram and bill of material are included with each unit shipped. If correspondence with the factory is necessary, please provide the unit model and serial number.

### C. Optional Factory Service

Periodic service on any piece of mechanical equipment is necessary for efficient operation. A nationwide service support network is available to provide quick and dependable servicing of make-up air, heating, ventilating, or air handling types of equipment. The factory also offers start-up service, which includes the presence of a service engineer to supervise the initial start-up and adjustment of the equipment and provide instructions for the owner's maintenance personnel in proper operations and maintenance. Consult factory for quotations on periodic or start-up service.

## SECTION III - INSTALLATION

### FOR CANADIAN INSTALLATIONS ONLY

1. All installations must conform with local building codes, or in the absence of local codes, with current CAN/CGA-B149-Installation Codes for Gas Burning Appliances and Equipment.
2. All electrical connections must be in accordance with Canadian Electrical Code, Part 1, CSA Standard C22.1.

All electrical connections must conform to the current edition of ANSI/NFPA No. 70 National Electrical Code and applicable local codes: in Canada, to the Canadian Electrical Code, Part 1 CSA Standard C22.1. The following recommendations are not intended to supplant any requirement of federal, state, or local codes having jurisdiction. Authorities having jurisdiction should be consulted before installations are made. Local codes may require additional safety controls and /or interlocks. All installations in airplane hangers must be in accordance with current ANSI/NFPA No. 409. All installations in public garages must be in accordance with current NFPA No. 88A and NFPA No. 88B.

**CAUTION: Do not install heating system in corrosive or flammable atmospheres! Premature failure of, or severe damage to the unit will result!**

**CAUTION: Heating system must not be installed in locations where air for combustion would contain chlorinated, halogenated or acidic vapors. If located in such an environment, premature failure of the unit will occur!**

### A. Handling the Equipment

As explained previously, the basic unit is designed for shipping in one piece where shipping limitations allow. Some optional accessories may require field mounting.

The IFJ unit has been designed for rigging and handling through the use of special lifting lugs installed on the top and/or sides of each unit. When unloading and setting the unit, use the lifting lugs provided or move the equipment on rollers. Hooks, jacks, or chains must not be used around the casing, main control panel or exterior mounted controls.

During transit, unloading and setting of the unit; bolts and nuts may have become loosened, particularly in the pillow block ball bearing assemblies in the fan section. It is recommended that all nuts and set screws be tightened. Turn fan shaft by hand to make certain that blower does not rub against blower housing, and that bearing set screws are tight.

If units are not set immediately, cover all openings that might be exposed to the weather.

Rotate fans monthly.

**IMPORTANT: Lift and install the modules or sections of a unit separately. Flange connections provided between modules or sections are not structural and damage will occur if any attempt is made to lift modules that have flanged together.**

**See the specification sheet and submittal drawing for unit or section weight and to determine proper orientation for each section.**

When unloading sections and/or units or moving equipment to its final location, exercise care to avoid distortion. Lift sections and/or units only by the lifting lugs provided.

### WARNING

#### BASE SECTION MAY TIP OVER

The base section, with the control panel, is top heavy to the front side. Use extreme caution when moving this section from the sides or rear with a fork lift or similar machine.

### RIGGING AND MOUNTING – IFJ UNITS

**Warning: To insure that a proper unit lift is made, lift unit approximately 24 inches and verify proper center of gravity lift point. To avoid dropping of unit, reposition lifting point if unit is not level. Failure to properly lift unit could result in death or serious injury or possible equipment or property-only damage.**

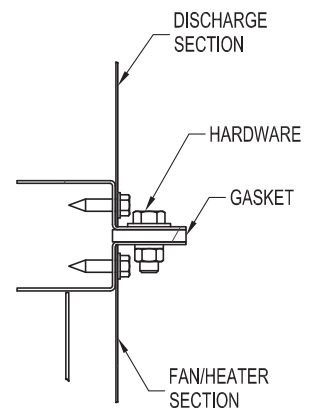
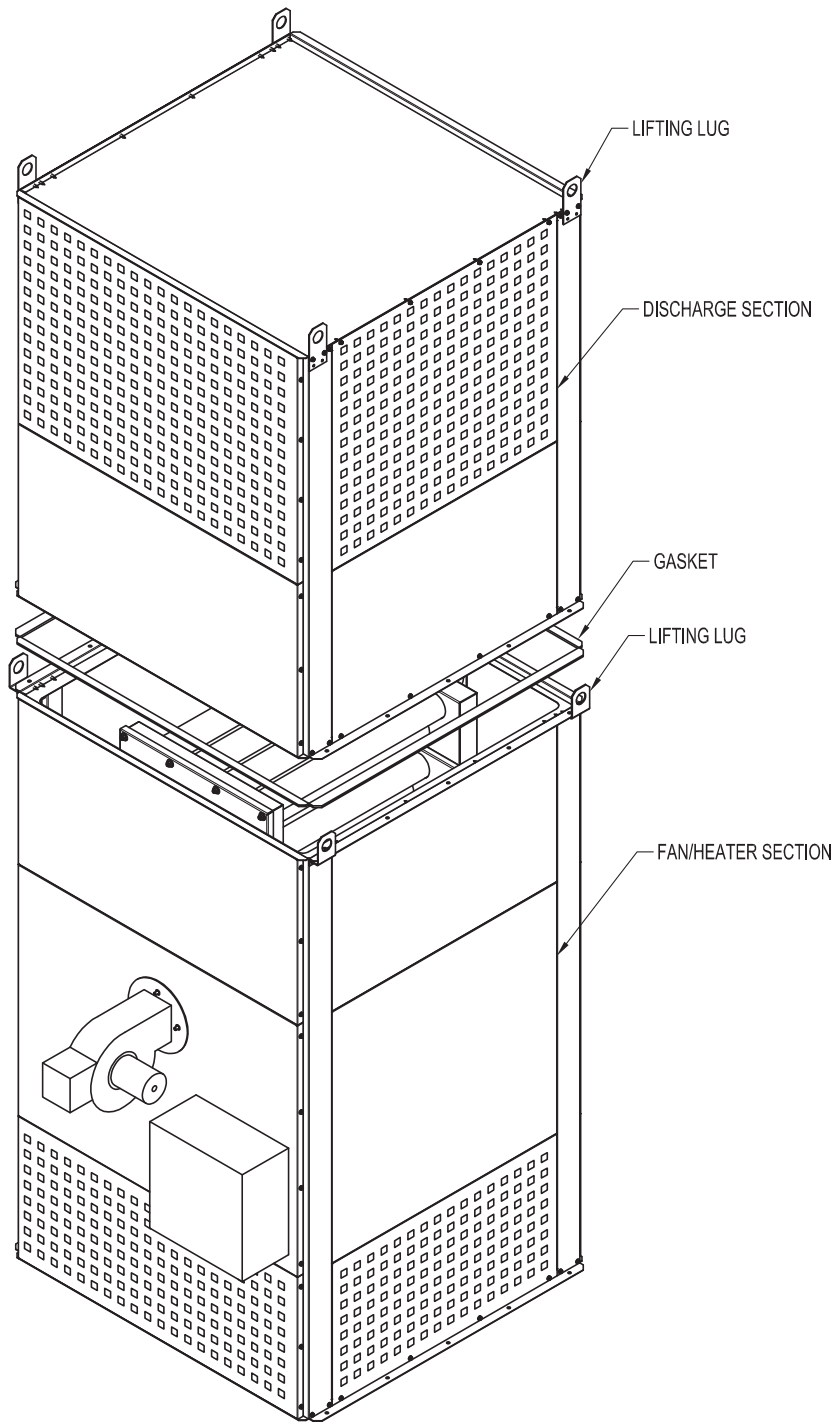

**CONNECTION DETAIL**

C000725

**B. Locating the Unit**

Prior to locating the unit, authorities having jurisdiction should be consulted before installations are made. Approval permits should be checked against the unit received.

The unit should be installed on a non-combustible pad or concrete flooring with adequate clearances for service, air intake and air discharge. The unit should be located with the rear of the cabinet as close to the wall as the applicable codes will allow. In the absence of any code, position as near to the wall as the flue pipe, draft regulator, and field supplied draft inducer (if applicable) will allow.

Combustion air shall be provided at a rate of at least 10 CFM, or 1 square inch of free opening, per 1000 BTU per hour of rated input. If a separate mechanical means provides this air, an interlock with the combustion blower shall be provided.

The rated output of gas burning appliances decreases with higher altitudes above 2,000 feet, the furnace shall be de-rated 4 % for each additional 1,000 feet of altitude above sea level. Factory testing rating plate information is recorded on sea level conditions. High altitude ratings may be obtained by a change in manifold pressure. Appliances must be suitably marked to indicate their altitude adjusted input rating.

Under no circumstances should this equipment be installed in a negatively pressurized space. Consult jurisdictional authority for proper ventilation requirements.

Combustion air containing or recirculation of room air may be hazardous in the presence of:

- a) Flammable solids, liquids and gases.
- b) Explosive materials (i.e., grain, dust, coal dust, gunpowder, etc).
- c) Substances, which may become toxic when, exposed to heat (i.e., refrigerant, aerosols, etc.).

Locate the unit exactly level. Special attention should be given to the electrical, and fuel connection points.

The minimum clearance to combustible material must be maintained as listed in Table 1

**Table 1**

Minimum clearance to combustible material, also, consult local codes and regulations.

Clearances to Combustible Material	
Vertical Units	
Front*	48 inches
Rear	18 inches
Right	18 inches
Left	18 inches
Top	18 inches
Floor	Zero

\*Consider control side as front of unit

In addition to the combustible clearances listed above, access for service should be allowed around the unit. The recommended minimum access clearance is shown in Table 2.

**Table 2**

Unit Size	Minimum Access*
All Sizes	Front and Sides 48 inches

\*Optimum clearance for shaft removal would be equivalent to cabinet width.

**Make a visual inspection to insure no damage has occurred to the unit during installation.**

If the unit is located within ten (10) feet of a wall, place the solid (blank) side of the discharge facing the wall.

Place the base section (with blower or fan) in the desired location. Attach the bottom flange of the unit to floor using anchors, lag bolts or screws. Gasket the top flange and carefully position coil box, extension plenum, or discharge section on top of base section and attach with nuts and bolts and caulk the seams. Continue adding other sections on top as required.

**WARNING**  
**BASE SECTION MAY TIP OVER**  
**The base section, with the control box, is top heavy to the front side. This section MUST be securely fastened to the non-combustible pad or concrete flooring BEFORE attempting to assemble the other section(s) to it.**

**IMPORTANT – Barriers should be provided to protect the unit and the integrity of utility piping to the unit from any collision with forklifts or other hazards within the selected location. Do not obstruct combustion air openings or ventilation grilles.**

### C. Location of Accessories

Where applicable, standard or optional accessories will be placed inside the fan section of the unit for shipment, and must be removed and installed by the mechanical or electrical contractor.

Remotely located discharge or inlet dampers must be equipped with an end switch and interlocked to insure maximum design opening before starting and running circuits may be energized.

Field constructed intake accessories should be properly designed to minimize the entry of rain and snow.

**Each unit comes with a Draft Regulator and a field supplied Draft Inducer may also be supplied. It is very important that you follow the installation instructions provided with these parts regarding location, mounting and adjustments. These instruction sheets should be available for the start-up technician.**

### D. Electrical Connections

**Warning: Open all disconnect switches and secure in that position before wiring unit. Failure to do so may result in personal injury or death from electrical shock.**

**Warning: Controls must be protected from water. Do not allow water to drip on the electrical controls.**

**Note: Before installing any wiring, check the unit rating plate for power supply voltage, and minimum amperage.**

All electrical connections must conform to the current edition of: ANSI/NFPA No. 70 National Electrical Code and applicable state and local codes; in Canada, to the Canadian Electrical Code, Part 1 CSA Standard C22.1 and applicable provincial and local codes. Since shipment of unit may require disassembly after factory check and test, reconnection of some electrical devices will be required in the field. Connect electrical wires (supplied in factory furnished conduit) to appropriate terminals. All leads are tagged to facilitate field connections. See wiring diagram provided with equipment. Complete all wiring to any optional accessories as shown on unit bill of material and electrical wiring diagram as required before applying voltage to the unit.

If damper actuators require field wiring, be sure the gasket and cover are securely mounted and assembly is watertight.

Entry location for all field-installed and control wiring is through the control panel.

If optional disconnect is not furnished with heater, the field provided disconnect must be of the proper size and voltage. Refer to unit nameplate for minimum circuit ampacity and voltage. The disconnect must be installed in accordance with Article 430 of the current edition of ANSI/NFPA No. 70 National Electrical Code, and applicable local codes; in Canada, to the Canadian Electrical Code, Part 1, CSA Standard C22.1.

Check the supply voltage before energizing the unit. The maximum voltage variation should not exceed  $\pm 10\%$ . Phase voltage unbalance must not exceed 2%.

**NOTE: Should any original wire supplied with the heater have to be replaced, it must be replaced with wiring material having a temperature rating of at least 105°C.**

### E. Venting

All venting installations must conform to Part 7, Venting of Equipment in the current version of the National Fuel Gas Code ANSI Z223.1, or applicable provisions of local building codes. The National Fuel Gas Code is subject to change, questions regarding venting requirements should be directed to the local authority having jurisdiction.

**All Indirect Fired Units are Category III appliances and must be vented.** Each unit must have an individual vent pipe and vent terminal.

Recommended vent pipe is 14 Gauge Series Stainless Steel. DO NOT support the weight of the stack draft regulator or field supplied draft inducer on the unit. Insulate single wall vent pipe exposed to cold air or running through unheated areas. Use as few elbows as possible and tape flue pipe joints with fireproof paper or other approved material.

The venting system for these heaters shall terminate at least four feet below, four feet horizontally from, or one foot above any door, window, or gravity air inlet into any building. All vents must be able to maintain the negative draft shown on rating plate in high fire.

**The vent pipe diameter must be a minimum of 8" in diameter.**

The vent pipe should be fitted with a drip leg with a clean out and a drain plug in the bottom. The vent pipe shall be constructed so that any water that collects in the stack will remain in the stack drip leg and not drain into the heat exchanger. Be sure drip leg is made so water will not fall on heater controls when drain plug is removed.

Pitch horizontal pipes downward ¼ inch per foot toward outlet for condensate drainage. Support horizontal runs as required to prevent sagging.

Vents should terminate that would not cause a down draft to occur. This could affect the negative pressure required in the heat exchanger. Do not install dampers or other restrictive devices in the flue vent pipe. The draft regulator or field supplied draft inducer are the only approved devices to be used on this heater.

The stack should not be installed in such a manner that access to the components is obstructed. Guy wires may be required to brace the stack above rooflines.

**WARNING: CARBON MONOXIDE! Your venting system must not be blocked by any snow, snow drifts, or any foreign matter. Inspect your venting system to ensure adequate ventilation exists at all times! Failure to heed these warnings could result in carbon monoxide poisoning (symptoms include grogginess, lethargy, inappropriate tiredness, or flu-like symptoms).**

#### **F. Field Piping Gas Piping**

All gas piping must be in accordance with the requirements outlined in the National Fuel Gas Code – ANSI Z223.1. It is required that a ground union be installed adjacent to the manifold for easy servicing. A drip leg and/or filter should be provided upstream of the unit's inlet gas connection. An additional shut-off must be located external of the unit's enclosure where required by local code. The location of this valve must comply with all local codes. A 1/8 inch N.P.T. plugged tapping, accessible for test gauge connection, must be installed immediately upstream of the gas supply connection to the unit.

**WARNING: To avoid equipment damage or possible personal injury, do not connect gas piping to this unit until a supply line pressure/leak test has been completed. Connecting the unit before completing the pressure/leak test may damage the unit gas valve and result in a fire hazard.**

**DANGER: Never use an open flame to detect gas leaks. Explosive conditions may exist which would result in personal injury or death.**

The gas line should be supported so that no strain is placed on the unit and does not rub on any surface. Pipe compounds, which are not soluble to liquid petroleum gases, should be used on threaded joints.

**CAUTION: The burner itself has been shipped attached to the front of the heater and combustion chamber. After shipping, it is possible the burner is no longer positioned properly as far as proximity to the chamber. This must be checked against the dimensional drawing for correct burner insertion into the chamber and set if necessary.**

Refer to the heater's rating plate to determine the minimum gas supply pressure for obtaining the maximum gas capacity for which this heater is specified.

Refer to the heater's rating plate to determine the maximum supply pressure to the heater.

**The appliance and the additional shutoff valve must be disconnected from the gas supply piping system during any pressure testing of that system at test pressures in excess of ½ PSIG.**

**The appliance must be isolated from the gas supply piping system by closing it's individual manual shutoff gas valve during any pressure testing of the gas supply piping system at test pressure equal to or less than ½ PSIG.**

Correctly sized piping must be run to the unit.

**Please note that gas line pressure must be as shown on specification plate when unit is operating at full input. The high-pressure regulator and relief valve should be, if possible, mounted at least 5 to 10 feet upstream from the gas valve on the unit (if applicable).**

#### **Refrigerant Piping**

Refer to drawing on following pages. Check to ensure refrigerant lines do not rub against the cabinet or other refrigerant lines.

#### **G. Field Wiring and Remote Control Installation**

1. If the optional low temperature was not an integral part of the heater, the factory recommends that a low temperature limit control be installed in areas where freeze protection is needed in the event of burner shut down.
2. Connect the power lines to the line side of the power distribution block or optional main disconnect switch.
3. Field wiring is indicated on the wiring diagram, typically dashed lines. Where field wiring of the control circuit is required, take care to size the wires for a maximum 10% voltage drop. The VA rating of the transformer should be the maximum load.
4. Mount and wire remote control panel, thermostat temperature sensors, and any other field-installed controls as indicated on the unit control-wiring diagram.
5. Connect all wiring to the appropriate field wiring terminal and any shielded or twisted wires as indicated on the unit control-wiring diagram.
6. Field wiring shall have a temperature rating of at least 105°C. The minimum size of the supply cable circuit shall be sufficient for the maximum ampacity of the heater.

FOR A 'SIZE 24 DOUBLE', DUPLICATE THE PIPING SCHEMATIC BELOW FOR THE SECOND COIL SECTION BUT DO NOT INSTALL A SECOND SET OF HOT GAS BY-PASS TEES - ITEM RP-09.

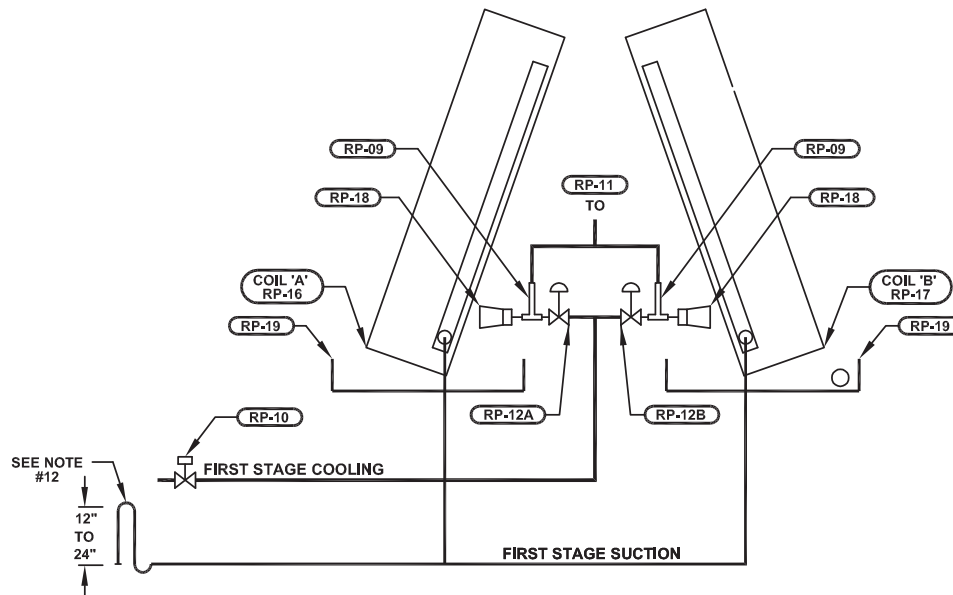

#### SIZE 24 COIL ASSEMBLY END ELEVATION

THE ABOVE PIPING SCHEMATIC SHOULD BE USED AS A GUIDE ONLY. ALTERNATE PIPING SCHEMES FOR ADDITIONAL STAGES OF DESIRED COOLING ARE POSSIBLE.

PROPER ENGINEERING DESIGN OF THE OVERALL REFRIGERATION SYSTEM MAY DICTATE AN ALTERNATE PIPING SCHEMATIC BE USED TO THE ONE ILLUSTRATED ABOVE.

#### GENERAL NOTES:

1. RECOMMEND FIRST STAGE OF COOLING BE PROVIDED WITH HOT GAS BYPASS.
2. ALL PIPING TO BE ACR TYPE 'L' COPPER.
3. ALL PIPING TO BE PITCHED IN THE DIRECTION OF REFRIGERANT FLOW. PITCH TO BE 1 INCH PER 10 FEET.
4. ALL SUCTION LINES TO BE INSULATED.
5. LIQUID LINE FILTER/DRIER, SIGHT GLASS, SUCTION LINE FILTER/DRIER, ISOLATION VALVES, FITTINGS, DISCHARGE VIBRATION ABSORBER, ACCUMULATORS AND OTHER AVAILABLE SYSTEM OPTIONS ARE NOT SHOWN.
6. RECOMMEND LONG RADIUS ELBOWS BE USED TO MINIMIZE SYSTEM PRESSURE DROP.
7. RECOMMEND LIQUID LINES FOR R-410A BE SIZED FOR A MAXIMUM PRESSURE DROP OF 6 PSIG.
8. RECOMMEND SUCTION LINES FOR R-410A BE SIZED FOR A MAXIMUM PRESSURE DROP OF 3 PSIG.
9. RECOMMEND CONDENSER SUBCOOLING CIRCUIT FOR R-410A BE CAPABLE OF SUBCOOLING LIQUID BETWEEN 12 TO 19°F.
10. CONNECT 1/4" O.D. EXTERNAL EQUALIZING LINE GENERALLY LOCATED IN EACH SUCTION HEADER OF EACH DX COIL TO THE APPROPRIATE THERMAL EXPANSION VALVE (TXV).
11. SENSING BULB FROM THERMAL EXPANSION VALVE (TXV) TO BE LOCATED ON THE SIDE OF A HORIZONTAL PORTION OF THE DX COILS' SUCTION LINE PIPING AT AN ANGLE OF APPROXIMATELY 120° FROM VERTICAL. DO NOT LOCATE SENSING BULB ON ANY PIPING USED IN A TRAP OR DOWNSTREAM OF A TRAP.
12. INSTALL TRAP IN SUCTION LINE AS ILLUSTRATED IF COMPRESSOR IS LOCATED BELOW THE THE DX COIL.
13. ALL COIL SPECIALTIES AND REFRIGERANT PIPING SHOWN OTHER THAN THE REFRIGERANT DISTRIBUTOR AND ANY OTHER REQUIRED REFRIGERATION SYSTEM SPECIALTIES ARE TO BE PROVIDED BY AND INSTALLED IN THE FIELD BY OTHERS.

#### COMPONENT IDENTIFICATION

RP-09	HOT GAS BYPASS TEE
RP-10	LIQUID LINE SOLENOID VALVE
RP-11	HOT GAS BYPASS VALVE - FIRST STAGE
RP-12A	THERMAL EXPANSION VALVE (TXV-1A) CIRCUIT #1 - COIL 'A'
RP-12B	THERMAL EXPANSION VALVE (TXV-1B) CIRCUIT #1 - COIL 'B'
RP-16	DX EVAPORATOR COIL 'A'
RP-17	DX EVAPORATOR COIL 'B'
RP-18	REFRIGERANT DISTRIBUTOR
RP-19	CONDENSATE PAN PROVIDED WITH DRAIN CONNECTION ON ONE (1) END ONLY.

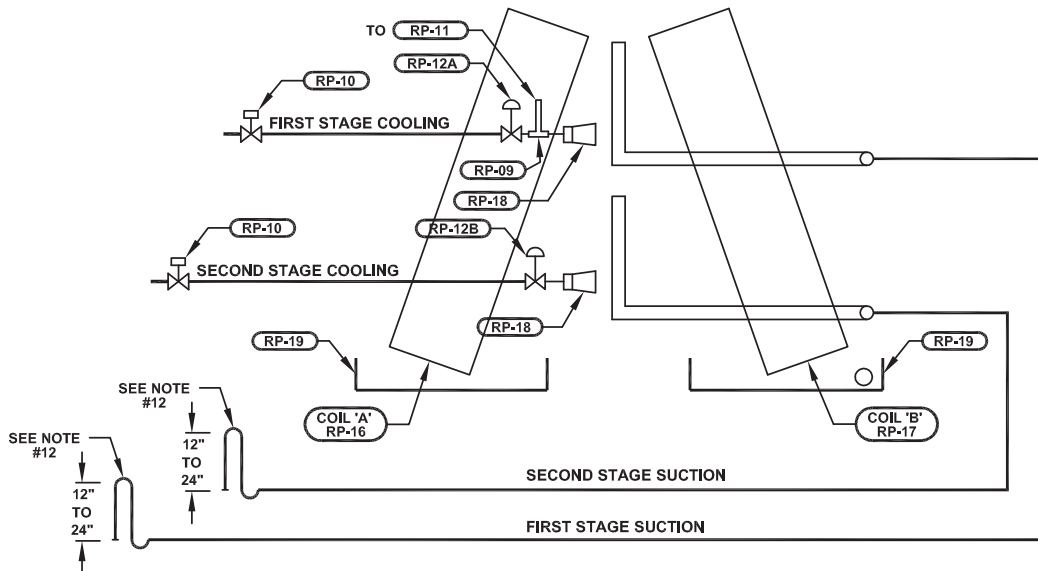

### SIZE 36 AND SIZE 42 COIL ASSEMBLY END ELEVATION

THE ABOVE PIPING SCHEMATIC SHOULD BE USED AS A GUIDE ONLY. ALTERNATE PIPING SCHEMES FOR ADDITIONAL STAGES OF DESIRED COOLING ARE POSSIBLE.

PROPER ENGINEERING DESIGN OF THE OVERALL REFRIGERATION SYSTEM MAY DICTATE AN ALTERNATE PIPING SCHEMATIC BE USED TO THE ONE ILLUSTRATED ABOVE.

#### GENERAL NOTES:

1. RECOMMEND FIRST STAGE OF COOLING BE PROVIDED WITH HOT GAS BYPASS.
2. ALL PIPING TO BE ACR TYPE 'L' COPPER.
3. ALL PIPING TO BE PITCHED IN THE DIRECTION OF REFRIGERANT FLOW. PITCH TO BE 1 INCH PER 10 FEET.
4. ALL SUCTION LINES TO BE INSULATED.
5. LIQUID LINE FILTER/DRIER, SIGHT GLASS, SUCTION LINE FILTER/DRIER, ISOLATION VALVES, FITTINGS, DISCHARGE VIBRATION ABSORBER, ACCUMULATORS AND OTHER AVAILABLE SYSTEM OPTIONS ARE NOT SHOWN.
6. RECOMMEND LONG RADIUS ELBOWS BE USED TO MINIMIZE SYSTEM PRESSURE DROP.
7. RECOMMEND LIQUID LINES FOR R-410A BE SIZED FOR A MAXIMUM PRESSURE DROP OF 6 PSIG.
8. RECOMMEND SUCTION LINES FOR R-410A BE SIZED FOR A MAXIMUM PRESSURE DROP OF 3 PSIG.
9. RECOMMEND CONDENSER SUBCOOLING CIRCUIT FOR R-410A BE CAPABLE OF SUBCOOLING LIQUID BETWEEN 12 TO 19°F.
10. CONNECT 1/4" O.D. EXTERNAL EQUALIZING LINE GENERALLY LOCATED IN EACH SUCTION HEADER OF EACH DX COIL TO THE APPROPRIATE THERMAL EXPANSION VALVE (TXV).
11. SENSING BULB FROM THERMAL EXPANSION VALVE (TXV) TO BE LOCATED ON THE SIDE OF A HORIZONTAL PORTION OF THE DX COILS' SUCTION LINE PIPING AT AN ANGLE OF APPROXIMATELY 120° FROM VERTICAL. DO NOT LOCATE SENSING BULB ON ANY PIPING USED IN A TRAP OR DOWNSTREAM OF A TRAP.
12. INSTALL TRAP IN SUCTION LINE AS ILLUSTRATED IF COMPRESSOR IS LOCATED BELOW THE THE DX COIL.
13. ALL COIL SPECIALTIES AND REFRIGERANT PIPING SHOWN OTHER THAN THE REFRIGERANT DISTRIBUTOR AND ANY OTHER REQUIRED REFRIGERATION SYSTEM SPECIALTIES ARE TO BE PROVIDED BY AND INSTALLED IN THE FIELD BY OTHERS.

#### COMPONENT IDENTIFICATION

RP-09	HOT GAS BYPASS TEE
RP-10	LIQUID LINE SOLENOID VALVE
RP-11	HOT GAS BYPASS VALVE - FIRST STAGE
RP-12A	THERMAL EXPANSION VALVE FOR CIRCUIT #1
RP-12B	THERMAL EXPANSION VALVE FOR CIRCUIT #2
RP-16	DX EVAPORATOR COIL 'A'
RP-17	DX EVAPORATOR COIL 'B'
RP-18	REFRIGERANT DISTRIBUTOR
RP-19	CONDENSATE PAN PROVIDED WITH DRAIN CONNECTION ON ONE (1) END ONLY.

### H. Locating Temperature Controls

The room or outdoor thermostats should be mounted where they will not be subjected to direct impact of the heated air or radiant heat from the sun. It is also recommended that thermostats, especially those with mercury bulb contacts, be mounted on a vibration free surface. The sides of building columns away from the heater or interior walls are usually the location best suited for mounting thermostats.

### I. Drains and Traps

#### Evaporator Coil – Blow Through

The cooling coil section can be located in the unit so that supply air is blown through the evaporative coil(s). A properly piped trap should be installed to control the condensate flow from the unit and also eliminate conditioned air from being blown out the condensate drain.

On initial start-up, it may be necessary to fill the trap manually or, after unit has operated sufficiently for a small amount of condensate to collect in the drain pan, turn off the unit and the trap will automatically fill.

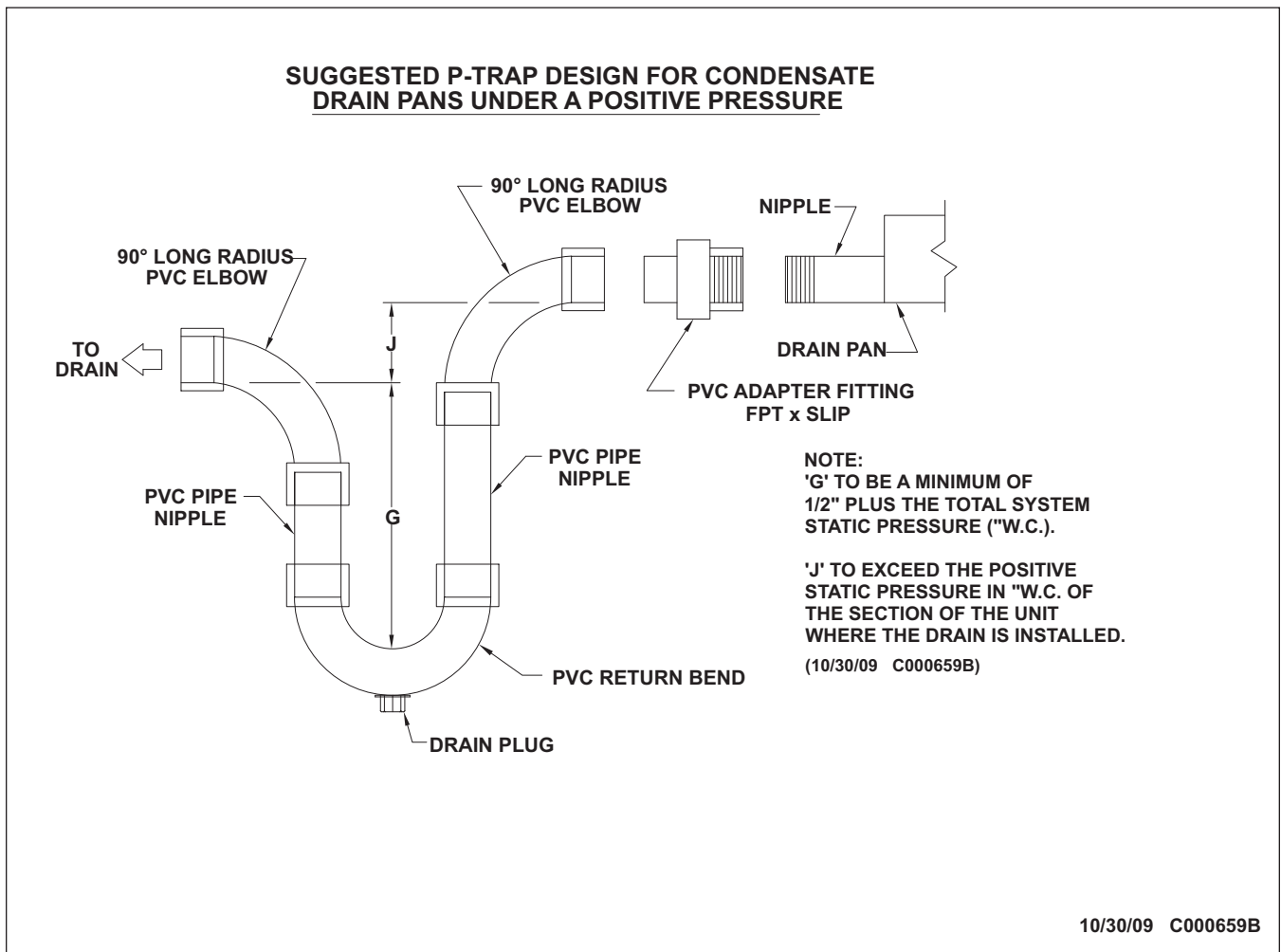

## SECTION IV – PRE START-UP

**Do not attempt start-up without completely reading and understanding this manual.**

### Pre Start-Up

The owners representative or equipment operator should be present during start-up to receive instructions on care and adjustments of the equipment.

All equipment has been factory tested, adjusted, metered and inspected to meet conditions set at the time the order was placed. Only minimal adjustments should be required. All information in this service manual is typical. All products are semi-custom and changes may occur.

**CAUTION: Line side of disconnect may be energized. Follow proper “lockout/tagout” procedures.**

**NOTE: A qualified service engineer should perform all servicing and adjustments of the Indirect Gas-Fired unit.**

Perform a visual inspection, internally and externally, to make sure no damage has occurred and that everything is secure. This inspection is very important and should be completed with great care given to detail. A good pre-start inspection will insure against possible unit damage on start-up and will save valuable analysis time.

1. Check that the physical condition of the unit exterior is acceptable.
2. Check that any insulation inside the unit is properly secured.
3. Check all terminals for loose connections and inspect all wiring terminations to insure that all crimped connections are tight.
4. Inspect the fan and motor bearings and lubricate if necessary.

**CAUTION: DO NOT RUPTURE GREASE SEALS.**

5. Inspect pulleys and belts for tightness, tension and alignment. **Do not overtighten belts.**
6. Check set screws on all bearings, pulleys, fans and couplings for tightness.
7. Check voltage supplied to disconnect switch; the maximum voltage variation should not exceed + 10%. Phase voltage unbalance must not exceed 2%.
8. Check thermostat(s) for normal operation.
9. Check that fans turn freely in housing.

10. Check that the area around the unit is clear of flammable vapors or containers of flammable liquids.
11. Visually inspect all fuel lines for damage and/or contact with a surface that can cause damage over time from rubbing. Check that all piping connections, particularly unions, are tight. Check all gas piping for leaks using a soap bubble solution. The most common types of problems found relative to the gas train itself is to make sure it is free of foreign material within the gas piping. This will interfere with the proper operation of the gas train components and burner. Purge all air from gas lines per gas codes.
12. Check that inlet gas pressure is the same as shown on the rating plate.
13. Check that all accessories requiring field wiring have been properly installed.
14. Check burner for proper location and alignment.
15. Check that filters, filter stops, accessories and any ship loose items are installed properly.
16. Check that vent lines (if applicable) are run to atmosphere on gas regulators and pressure switches for indoor units. Vent lines should terminate outside the building, with a turndown elbow and bug screen. Note that some units will use vent limiters and vent lines are not required. If vent lines are even partially plugged, this will interfere with proper venting of pressure control devices.
17. Check that all manual gas shut-off valves are closed.
18. When failure or malfunction of this heater creates a hazard to other fuel burning equipment, (e.g. when the heater provides make-up air to a boiler room), the heater is to be interlocked to open inlet air dampers or other such devices.
19. Motor overload relay setting should match the motor's nameplate full load amperage.
20. Check any dampers or mixing boxes (if supplied). Make sure all damper linkage is free to move and no binding will occur. If dampers are of the modulating type, check control capillary tubes to insure that the tubes and bulbs are in the proper location and will not rub against any other parts.
21. Check to ensure all manual reset safety devices have been reset and limits are in the normal operating position.
22. Check to make sure the draft regulator and field supplied draft inducer (if applicable) and airflow switch is wired and installed in the proper location. See the installation instructions accompanying these accessories.
23. Check that all fuses are installed.
24. Check to ensure the flue stack is installed properly and is free of obstructions.

## SUGGESTED TOOLS AND INSTRUMENTS

Volt/Ohm meter  
Tachometer  
Stack & Temperature Thermometer  
Gas Pressure Gauge (0 – 35 lbs.)  
Ammeter/Amprobe (or equal)

U-Tube Manometer (0 – 10" W.C.)  
Flue Gas Test Equipment  
Standard Hand Tools  
D.C. Volt Meter/Microammeter  
Draft Gauge

## SUGGESTED CONTROLS SETTINGS

FL-02 High Limit.....	200° F	PS-10 Main Air Proving Switch Adjust to field condition
PS-04 Low Gas Pressure Switch.....	1.0" W.C.	PS-12 Clogged Filter Switch.....Adjust to field condition
PS-07 High Gas Pressure Switch.....	125% above burner firing rate	TC-01 Room Thermostat ..... Customer Discretion

## BEFORE ATTEMPTING TO START THE HEATER, READ THE TYPICAL SEQUENCE OF OPERATION AS SHOWN BELOW:

**Typical Sequence Of Operations Note:** This sequence is written for only the burner safety and operating portion of the heater. The following sequence assumes all safety interlocks are closed and optional unit main disconnect switch (SW-01) is closed. Other control systems for dampers, mixing boxes, and temperature controls are included in the unit typical sequence of operation and/or wiring diagram:

1. With main supply air fan(s) on, thermostat calling for heat, and all switches and operating controls in their normal position, the field supplied Draft Inducer (if applicable) will be energized. At this time, voltage (24VAC) is applied to motor start relay and air switch. Once the fan motor reaches operating rpm, combustion air pressure is sensed by the air proving switch and closes the switch contacts energizing the S89F gas primary control.
2. The S89F gas primary control has an internal 30 second prepurge timer. After the initial 30 second prepurge, an internal 8 second safe start check of the 89F will commence. Once this is successfully completed, the S89F simultaneously energizes the gas valve and ignition transformer. Gas flows and the transformer produces an approximate 7300 volt spark end point grounded at the burner head establishing main burner flame.
3. At the start of each heat cycle, there is a trial for ignition period of four (4) seconds duration. Normally, burner flame will be established before the end of this period. Once the flame is established, sparking will cease and the flame rod will provide flame monitoring to the S89F gas control primary for the remainder of the heat cycle. If the flame should be extinguished during the heat cycle, the S89F gas control primary will go into the 30 second prepurge and a 8 second safe start check, then re-energize the gas valve and ignition transformer in an attempt to establish the main burn flame. If this does not occur within the 4 second trail for ignition period, the S89Fgas primary control will go into lockout, de-energizing the gas valve and ignition transformer.
4. To restart the system, the main power or thermostat must be de-energized momentarily, then re-energized. If at any time during the heat cycle, there is an insufficient supply of combustion air to the burner, the air switch will open, putting the system into lockout closing the gas valve.

## ROOM THERMOSTAT (TC-01) SEQUENCE:

### KEYS ARE USED TO:

- set current time and day
- program times and setpoints for heating and cooling
- override the program temperatures
- display present setting
- set system and fan operation
- perform simple configuration

### SYSTEM SETTINGS:

In the AUTO mode:

Thermostat automatically changes between heating and cooling based on indoor temperature.

In the COOL mode:

Thermostat controls two stages of cooling by energizing the optional cooling relays (RE-77 and RE-78). The cooling relays provide dry contacts for operating remote equipment.

### FAN SETTINGS:

In the ON mode:

The fan will run continuously in the occupied mode and will cycle with a call for cooling or heating in the unoccupied mode. The thermostat energizes the fan enable relay (RE-15) which will then enable the fan starter (ST-01).

In the AUTO mode:

Fan always cycles with call for heat or cool. The thermostat energizes the fan enable relay (RE-15) which will then enable the fan starter (ST-01).

### DEFAULT SETPOINTS:

Heating Occupied 70°F (21°C), Heating Unoccupied 55°F (13°C).

Cooling Occupied 75°F (24°C), Cooling Unoccupied 85°F (29°C).

### LOSS OF POWER:

The room thermostat (TC-01) maintains programmed times and temperatures for the life of the product. Clock and day information is retained for a minimum of 48 hours.

**NOTE: To achieve the 48-hour power-loss clock retention, the T7350 must be powered for at least five (5) minutes.**

### SERVICE SWITCH:

The service switch (SW-24) will de-energize the control circuit disabling the unit from running. Caution: the service switch does not disconnect all power.

### NIGHT SET BACK:

The night set back function is integral to the room thermostat (TC-01).

### TIME CLOCK:

The time clock function is integral to the room thermostat (TC-01) which has 365 day programming with up to two occupied and two unoccupied periods per day.

For a more detailed setup procedure, see the Troubleshooting Guide section for the T7350.

## SECTION V – UNIT START-UP

Before attempting to start the heater, you must read and understand this manual as well as the burner IOM, sequence of operation, electrical schematic, ignition control module and gas component instructions. You must also be familiar with the adjustment of the draft regulator and field supplied draft inducer (if applicable).

**WARNING: During installation, testing, servicing and trouble shooting of this product, it may necessary to work with live electrical components. Have a qualified licensed electrician or other individual who has been properly trained in handling live electrical components to perform these tasks. Failure to follow all electrical safety precautions when exposed to live electrical components could result in death or serious injury.**

**CAUTION: Danger of sharp metallic edges that can cause injury. Take care when servicing unit to avoid accidental contact with sharp edges.**

Make sure all manual gas valves are closed.

Make sure all doors and service panels have been closed or replaced.

Turn main disconnect switch off. Check the incoming line voltage to match unit nameplate rating. If voltage is over +10% of nameplate rating or phase voltage unbalance is over 2%, notify contractor or power company.

**If power supply meets requirements turn main disconnect switch on. Turn Fan “on-off” switch to “on” position. Inlet shut-off damper(s) (if applicable) opens, after end switch has proven damper is open the blowers or props run.**

Turn Fan “on-off” switch to “off” position. Check supply fans for proper rotation. The burner and draft inducer (if applicable) rotation can be checked when the heat section is started.

**NOTE: To change rotation of the fans, simply interchange any two (2) of the line leads of the motor starter for 3 phase motors. On single-phase motors, refer to motor nameplate.**

**Turn Fan “on-off” switch to “on” position. Check for proper fan RPM. Check that all amp draws do not exceed nameplate ratings and overloads are set to nameplate amps.**

Check to make sure all dampers and controls are working properly.

Turn Fan “on-off” switch to “off” position.

**NOTE: When setting up the burner for the first time or if the appliance has been shut down for an extended period of time, these same start up procedures should be followed.**

Open pilot and first main gas shut-off valves slowly.

Check the gas supply pressure by replacing the plug fitting on the inlet pressure tap of the gas valve with a pressure gauge with appropriate range. Check that pressure reading is within the specified range on the rating plate.

**NOTE: To adjust gas pressure on supply lines where a regulator has been installed (to set inlet pressure to rating plate maximum pressure), remove dust cap of main gas regulator and turn adjusting screw clockwise to increase pressure or counterclockwise to decrease pressure.**

Check main gas line for leaks using a soap solution.

### Setting the Main Flame

**CAUTION: Do not attempt to start the heater when furnace is full of vapor or combustion chamber is very hot.**

**CAUTION: At no time should you stand in front of the relief door.**

Connect manometer to the outlet pressure tap of the unit gas valve.

Connect a DC microammeter between the SENSE terminal and the flame rod sensing wire.

Depress the combination gas valve manual control knob and turn to "OFF" position.

Adjust the primary air to No. 4 and off-cycle damper to No.1-1/2.

**Turn Fan and Heat-Off-On switches to the ON position and check rotation of burner fan and field supplied draft inducer (if applicable).**

Set all thermostats to call for heat. Set inlet ductstat (if applicable) above outside air temperature.

If limits and all safety controls are closed, the burner and field supplied draft inducer (if applicable) will run for approximately 30 seconds before ignition trial as a pre-purge cycle.

Allow the burner to run a MINIMUM of five (5) minutes to purge combustion chamber and appliance heat exchanger.

Set the thermostat or operating control below room temperature, shutting the burner and field supplied draft inducer (if applicable) "OFF" for one ( 1) minute to RESET the primary control.

Depress the combination gas valve manual control now and turn to "ON" position.

Set the thermostat or operating control to call for heat. The burner will start and go through the applicable sequence of burner/primary gas control operation.

**NOTE: 3 or 4 trials may be needed to purge air from gas line.**

**CAUTION: If main flame does not light within a few seconds. Shut the burner down and repeat steps. You may have to eliminate air from the main gas line. The main gas pressure and/or burner air setting may also need to be readjusted.**

**WARNING: If any flame is observed when the burner is on standby, or if the ignition spark or valve operator is heard to come on before the burner reaches operating speed; immediately turn off the gas control and main power. A dangerous condition has developed and MUST be corrected.**

After the burner lights; adjust the orifice manifold pressure regulator (if necessary) using a manometer to match normal manifold pressure shown on unit nameplate.

Make sure the combustion air and gas pressure is sufficient to provide instant ignition, a stable flame, and flame signal.

After the desired input has been obtained, readjust the primary air damper open or closed to visually obtain a blue flame with well defined orange or yellow tips for natural gas, or well defined yellow tips for propane gas.

Check all gas piping again for leaks using a soap bubble solution.

See final checks and adjustments.

## FINAL CHECKS AND ADJUSTMENTS

After the burner has been in operation for at least ten (10) minutes, assuring combustion chamber and heat exchanger are fully warmed; take combustion analysis flue gas samples just ahead of the draft control in the flue pipe.

**NOTE: ALWAYS USE RELIABLE COMBUSTION TEST INSTRUMENTS. BEING PROFICIENT IN THE USE OF THESE INSTRUMENTS AND INTERPRETING COLLECTED DATA IS NECESSARY FOR SAFE, RELIABLE AND EFFICIENT BURNER OPERATION.**

The following readings should be taken but not limited to:

CO <sub>2</sub> %	Net Stack Temperature
O <sub>2</sub> %	Combustion Efficiency
CO %	

If necessary, make adjustments on burner air shutter. **DO NOT** change the fuel input rate. The draft regulator must be adjusted by adding or removing the washer type weights supported by the two chains. Do not move the weight attached directly to the gate.

The following list covers general combustion problems and some of the possible cures. Conditions may vary in the field. Refer to combustion chart for efficiency.

**CAUTION: Check local codes for maximum allowable percentages and amounts of emissions.**

Low Carbon Dioxide (CO<sub>2</sub>)

- Fuel input too low
- Excess burner air
- Wrong draft setting

## SAFETY AND CONTROLS CHECKOUT

**Ignition Module** – Close the manual gas valve before burner. Operate unit in heat mode. The ignition module must trip out within 5 seconds after try for ignition is complete.

**Temperature Controls** – The temperature controls are checked by adjusting control to a higher temperature to allow burner to cycle on. Adjust control to a lower temperature to allow burner to cycle off. Return the adjustment to its original setting.

Detectable Carbon Monoxide (CO)

- Fuel input too high
- Not enough burner air
- Restricted draft
- Flame impingement

Excessive Stack Temperature (480°F Above Ambient)

- Draft setting too high
- Excess burner air
- Fuel input too high
- Blocked and/or restricted secondary tubes

Low Oxygen (O<sub>2</sub>)

- Oxygen reading must always be a positive percentage

Make sure there is a minimum of –0.02" W.C. at relief door when burner is in high fire with a warm stack.

Cycle burner several times to ensure smooth light off and proper operation. Visually observe the flame pattern. There must be no flame impingement or hot spots on the combustion chamber that could cause scaling.

Check voltage and amperage on all motors.

Check all dampers, linkages, and locking quadrants to make sure they are secure and operating correctly.

Check all gas piping for leaks.

**Limit Controls** – The limit controls are checked by adjusting control to a lower temperature setting while the unit is operating on high fire and observe cut-off. Return the adjustment to its original setting. Manual reset may be required on some controls.

**Make sure all the safeties and controls are working properly.**

## SECTION VI - UNIT SHUTDOWN

### A. Extended Shutdown

1. Disable the heat for 3 minutes, or a sufficient amount of time to allow the heat exchanger to cool down. Then disable the fans.
2. Close all the manual gas shut off valves.
3. Open the main electrical disconnect switch.
4. If the unit is to remain idle for an extended period, the fan and motor shafts should be rotated by hand to spread the grease over the bearings.

### B. Emergency Shutdown Only —

1. Open the main electrical disconnect switch.
2. Close the main manual gas valve.

## SECTION VII - TROUBLE SHOOTING

### Check Safety Shutdown Performance

**WARNING: Fire or explosion hazard. Can cause property damage, severe injury or death. Perform the safety shutdown test any time work is done on a gas system.**

**NOTE: Read steps 1 through 7 before starting, and compare to the safety shutdown or safety lockout tests recommended for the ignition module. Where different, use the procedure recommended for the module.**

1. Turn off gas supply.
2. Adjust setpoint above room temperature to call for heat.
3. Watch for ignition spark following prepurge. See ignition module specifications.
4. Time the length of the spark operation. See the flame safeguard relay module specifications.
5. After the module locks out, open the manual gas cock and make sure no gas is flowing to the pilot or main burner.
6. Reset the ignition relay (RE-02).
7. Operate system through one complete cycle to make sure all controls operate properly.

This equipment has been electrically and fire tested prior to shipment. However, during transit control setpoints can change, and wiring can come loose. Do not assume controls are defective until all associated setpoints and wiring are checked.

The following is a simplified list of possible problems and typical causes and remedies. However, it does not cover all possibilities, and is intended as a guide only.

**Refer to the burner manufacturer IOM for additional instructions.**

**WARNING: Many of the steps listed on the following pages require electrical cabinet and blower access while the unit is powered. High voltage and moving parts are present, and these steps should be performed by qualified service personnel. If any of the controls requiring manual reset were at fault this is an indication of a problem with the system that should be investigated.**

## SECTION VII - TROUBLESHOOTING *continued*

Symptom	Cause	Remedy
A. Supply fan does not run.	<ol style="list-style-type: none"> <li>1. Low or no voltage.</li> <li>2. Fuse(s) blown.</li> <li>3. Customer's interlock not closed or connected.</li> <li>4. Room thermostat (TC-01) not working.</li> <li>5. Fan "On-Off" Switch (SW-24) in "Off" position.</li> <li>6. (RE-15) Contacts open.</li> <li>7. Damper motor not operating, its end switch not making, or dampers binding (if applicable).</li>   <li>8. Overload protection on motor starter tripped.</li>   <li>9. Belt(s) loose or broken (if applicable).</li> <li>10. Motor may be burnt out or incorrectly wired.</li> <li>11. Bearing seized on shaft.</li> </ol>	<ol style="list-style-type: none"> <li>1. Check power source.</li> <li>2. Replace fuse(s).</li> <li>3. Close or connect customer interlock.</li> <li>4. See Troubleshooting Guide for T7350 thermostat.</li> <li>5. Place switch in "On" position.</li>   <li>6. Check for power and/or replace.</li> <li>7. Check for power at damper motor and that end switch has been wired correctly. End switch should be wired N.O. (normally open). Clear linkage.</li> <li>8. Reset the starter by pushing red button on starter, check amp draw.</li> <li>9. Turn power off and check belts.</li> <li>10. Turn power off and check motor and wiring.</li> <li>11. Turn power off and check bearings.</li> </ol>
B. Line voltage is not present at burner.	<ol style="list-style-type: none"> <li>1. Fan "On-Off" Switch (SW-24) in "Off" position.</li> <li>2. Room thermostat (TC-01) not working.</li> <li>3. Auxiliary switch on starter not closed.</li> <li>4. (RE-28) Contacts open.</li> <li>5. High temperature limit is open.</li> <li>6. High-Low gas pressure switches open.</li> <li>7. Field installed Draft Inducer motor not running.</li> <li>8. Field installed Draft Inducer air proving switch is open.</li> </ol>	<ol style="list-style-type: none"> <li>1. Place switch in "On" position.</li> <li>2. See Troubleshooting Guide for T7350 thermostat.</li> <li>3. Check auxiliary circuit wiring and contacts.</li> <li>4. Check for power and/or replace.</li> <li>5. Check limit for proper settings.</li> <li>6. Correct gas pressure and reset switches.</li> <li>7. Check wiring, fuses, and amp draw on motor.</li> <li>8. Check for correct rotation and switch operation. See Operating Manual for proper installation and adjustment.</li> </ol>
C. Burner motor does not run.	<ol style="list-style-type: none"> <li>1. 24 Volts is not present on low voltage transformer.</li> <li>2. Motor start relay contacts do not close.</li> <li>3. Motor shaft does not turn freely.</li> </ol>	<ol style="list-style-type: none"> <li>1. Check wiring and connection. Correct or replace if defective.</li> <li>2. Check wiring and connection. Correct or replace if defective.</li> <li>3. Check for motor clearance. Correct or replace motor if defective.</li> </ol>

## SECTION VII - TROUBLESHOOTING *continued*

Symptom	Cause	Remedy
D. Ignition Control Module goes into safety shut down (Lockout).	1. See technical data sheets on Ignition Control Module.	1. Determine the cause of lockout.
E. If burner does not light after pre-purge has timed out and there is no voltage at Ignition Control Module input terminals.	1. Low voltage transformer defective. 2. Burner air proving switch is open.	1. Check wiring and connection. Correct or replace if defective. 2. Check for correct switch operation or replace if defective.
F. Burner does not light after pre-purge has timed out and voltage is present on Ignition Control Module input terminals.	1. Ignition Control Module defective. 2. Manual gas shut-off valve closed. 3. Inlet gas pressure lower than minimum gas pressure required. 4. No gas through high gas pressure regulator with sufficient inlet gas pressure. 5. No gas flow through combination gas valve. 6. Type of gas supplied (natural gas or propane) different than shown on unit rating plate. 7. Flame detection system not sensing flame. (See section for servicing burner). 8. No voltage on secondary side of ignition transformer. 9. Gas orifices obstructed or plugged.	1. Replace Ignition Control Module. 2. Slowly open valve. 3. Increase gas pressure. 4. Clear obstruction in vent orifice or line, replace if defective. 5. Check for proper installation, and voltage. Correct or replace if defective. 6. Connect to proper fuel supply or contact factory for field conversion parts. 7. Assure flame rod is in flame, check wiring, and flame rod. 8. Check wiring. Replace transformer if defective. 9. Clear obstruction or blockage.
G. If burner lights but loses flame during cycle and a stable microampere current of 0.8 cannot be obtained.	1. Flame proving circuit grounded by moisture. 2. Damaged insulation on flame rod or not properly positioned in flame. 3. Poor ground path to primary control module. 4. Ignition control locks out.  5. Poor combustion levels.	1. Check for proper installation and/or correct. 2. Check wiring along with flame rod position. Correct and/or replace if defective. 3. Check to be sure unit is properly grounded. 4. Check wiring and connections. Correct and/or replace if defective. 5. Perform a flue gas analysis and correct any combustion setup issues.
H. Burner cycles erratically.	1. Low voltages.  2. Thermostats, safeties and/or switches opening and closing.	1. Check for proper voltage and amperage on burner motor and gas valve. Replace if defective. 2. Check operation and replace if defective.

See burner Installation, Operation, and Maintenance Manual for additional troubleshooting

## SECTION VII - TROUBLESHOOTING *continued*

Symptom	Cause	Remedy
A. Insufficient cooling	<ol style="list-style-type: none"><li>1. Cooling thermostat not working properly.</li><li>2. (RE-77 and RE-78) contacts not closed.</li><li>3. Evaporator coil freezing.</li> <li>4. Incorrect refrigerant charge.</li></ol>	<ol style="list-style-type: none"><li>1. See Troubleshooting Guide for T7350 thermostat.</li><li>2. Check for power and/or replace if defective.</li><li>3a. Thermostat setting too low.</li><li>3b. Check filters. Clean or change as needed.</li><li>3c. Check adjustments of TXV and bulb location.</li><li>3d. Check airflow.</li><li>4. Check for correct superheat and subcooling.</li></ol>

# T7350 Commercial Programmable Thermostat

## FOR SINGLE- OR MULTI-STAGE CONVENTIONAL/ HEAT PUMP SYSTEMS

### INSTALLATION INSTRUCTIONS

#### APPLICATION

The T7350 Commercial Programmable Thermostat controls 24 Vac commercial single zone heating, ventilating and air conditioning (HVAC) equipment. The T7350 consists of a thermostat and subbase. The thermostat includes the display and keypad for 7-day programming. The subbase includes equipment control connections. The subbase mounts on the wall and the thermostat mounts to the subbase.



#### MERCURY NOTICE

If this control is replacing a control that contains mercury in a sealed tube, do not place your old control in the trash. Dispose of properly.

Contact your local waste management authority for instructions regarding recycling and the proper disposal of an old control. If you have questions, call Honeywell Customer Care Center at 1-800-468-1502.

#### INSTALLATION

##### When Installing this Product...

1. Read these instructions carefully. Failure to follow them could damage the product or cause a hazardous condition.
2. Check ratings given in instructions and on the product to ensure the product is suitable for your application.
3. Installer must be a trained, experienced service technician.
4. After installation is complete, check out product operation as provided in these instructions.



#### CAUTION

**Electrical Shock or Equipment Damage Hazard.**  
**Can shock individuals or short equipment circuitry.**  
Disconnect power supply before installation.

#### Location

Do not install the thermostat where it can be affected by:

- drafts or dead spots behind doors and in corners.
- hot or cold air from ducts.
- radiant heat from sun or appliances.
- concealed pipes and chimneys.
- unheated (uncooled) areas such as an outside wall behind the thermostat.

#### IMPORTANT

*To avoid electrical interference, which can cause erratic performances, keep wiring runs as short as possible and do not run thermostat wires adjacent to the line voltage electrical distribution systems. Use shielded cable. The cable shield must be grounded only at the controlled equipment case.*

#### Subbase

##### WHEN USED TO SENSE ROOM TEMPERATURE

Install the thermostat about 5 ft. (1.5m) above the floor in an area with good air circulation at average temperature. (See Fig. 1.)

##### WHEN NOT USED TO SENSE ROOM TEMPERATURE

When using the remote-mounted temperature (and humidity) sensor(s) to sense ambient conditions, install the thermostat in an area that is accessible for setting and adjusting the temperature and settings.



#### CAUTION

**Equipment Damage Hazard.**  
**Can damage the TIM connection beyond repair.**

Disconnect the TIM cable prior to opening or closing the thermostat cover.

NOTE: Allow sufficient clearance below the thermostat to plug in the TIM cable.

Install the remote-mounted sensor(s) about 5 ft. (1.5m) above the floor in an area with good air circulation at average temperature. (See Fig. 1.)

If multiple remote sensors are required, they must be arranged in a temperature averaging network consisting of four sensors. (See Fig. 2.)



NOTE: Only TR21 models with no setpoint adjustment can be used for temperature averaging.

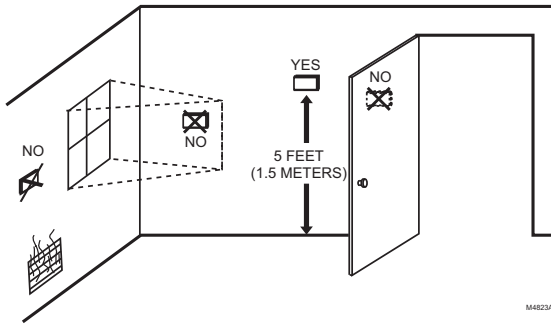

Fig. 1. Typical location of thermostat or remote-mounted sensor.

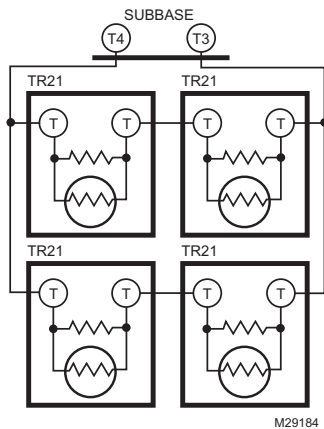

Fig. 2. Four TR21 sensors providing temperature averaging network for T7350 Thermostat.

## Mounting Subbase

The subbase mounts horizontally.

### IMPORTANT

- When using the internal temperature or humidity sensor, the device must be mounted horizontally (with the LCD facing upwards). Precise leveling is not needed.
- When using remote room temperature and humidity sensors, thermostat mounting orientation does not matter.

Wall mounting (using standard drywall screws) is standard. Mounting to a 2 in. by 4 in. (50.8 mm by 101.6 mm) wiring box can be accomplished:

- for a horizontal box, no extra hardware is required.
- for a vertical box, part 209651A is required.
- Mount to European standard wall box (having 2.4 in. (60.3 mm) between mounting screws in a horizontal line) with or without adaptive hardware.

1. Position and level the subbase.

NOTE: A level wallplate is only for appearance. The thermostat functions properly even when not level.

2. Use a pencil to mark the mounting holes. (See Fig. 3.)
3. Remove the subbase from the wall and drill two 3/16 in. (4.8 mm) holes in the wall (if drywall) as marked. For firmer material such as plaster or wood, drill two 7/32 in. (5.6 mm) holes.
4. Gently tap anchors (provided) into the drilled holes until flush with the wall.
5. Position the subbase over the holes, pulling wires through the wiring opening.
6. Loosely insert the mounting screws into the holes.
7. Tighten mounting screws.

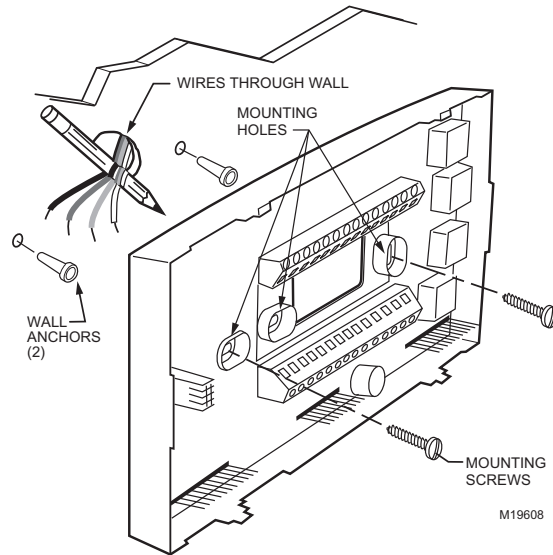

Fig. 3. Mounting the subbase.

## Mounting Thermostat on Subbase (Fig. 4)

With the subbase installed, mount the thermostat:

1. Engage top subbase tabs into the thermostat top.
2. Swing the thermostat down.
3. Press the lower edge of the case to latch.

NOTE: To remove the thermostat from the wall, first pull out at the bottom of the thermostat; then remove the top.

## Wiring

Follow equipment manufacturer wiring instructions when available. Refer to the Wiring Diagram section starting on page 8 for typical hookups. A letter code is located near each terminal for identification.

### IMPORTANT

All wiring must comply with local electrical codes and ordinances.

NOTE: Maximum (and recommended) wire size is 18-gauge. Do not use wire smaller than 22-gauge.

1. Loosen subbase terminal screws and connect system wires.
2. Securely tighten each terminal screw.
3. Push excess wire back into the hole in the wall.
4. Plug the hole with nonflammable insulation to prevent drafts from affecting the thermostat.

NOTE: See Fig. 5 for keypad information.

A. ENGAGE TABS AT TOP OF THERMOSTAT AND SUBBASE OR WALLPLATE.

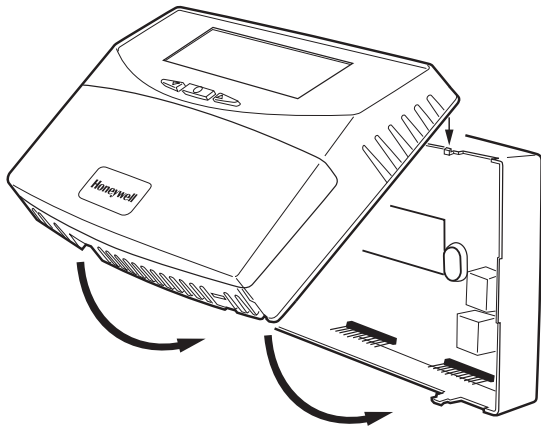

B. PRESS LOWER EDGE OF CASE TO LATCH.

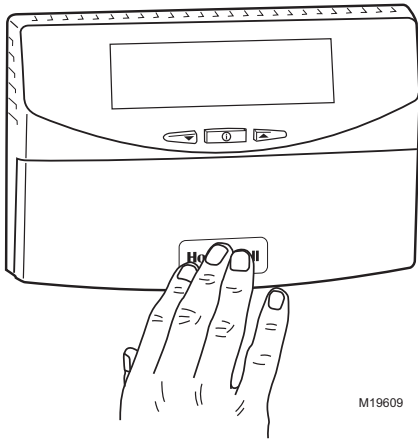

Fig. 4. Mounting thermostat on subbase.

### Setting Temperature

Refer to Table 2 for the default temperature setpoints. See the Product Data (form 63-2605) for complete instructions on changing the setpoints.

### Setting System and Fan

System default setting is Auto. Fan default setting is On.

NOTE: Use *System* and *Fan* keys to change settings.

### System Settings

- Auto: Thermostat automatically changes between heating and cooling based on indoor temperature.
- Cool: Thermostat controls cooling.
- Off: Heating, cooling, and fan are all off.
- Heat: Thermostat controls heating.
- Em Heat: Auxiliary heat serves as first stage. Compressor stages are locked off.

### Fan Settings

- On: See Table 1.
- Auto: Fan always cycles with call for heat or cool.
  - Conventional: The equipment (i.e. plenum switch) controls fan operation in heat mode. Thermostat controls fan operation in cool mode.
  - Electric Heat: Thermostat controls fan operation in both heat and cool modes.

NOTES: Fan operation can extend (delay Off) after the heating/cooling turns off:

- Heating choices are 0 or 90 seconds.
- Cooling choices are 0 or 40 seconds.

Table 1. Fan on control logic.

Occupancy		Call for Heat/Cool	
Scheduled	Sensor Signal	Yes	No
Occupied	Occupied	On	On
Occupied	Unoccupied	On	Off <sup>a</sup>
Standby	*Doesn't Matter	On	Off <sup>a</sup>
Not Occupied	*Doesn't Matter	On	Off <sup>a</sup>

<sup>a</sup> In heat mode, when set for conventional heat, the equipment (i.e. plenum switch) could power the fan despite the T7350.

## SETTINGS

### Using Thermostat Keys

The thermostat keys are used to:

- set current time and day,
- program times and setpoints for heating and cooling,
- override the program temperatures,
- display present setting,
- set system and fan operation,
- perform simple configuration.

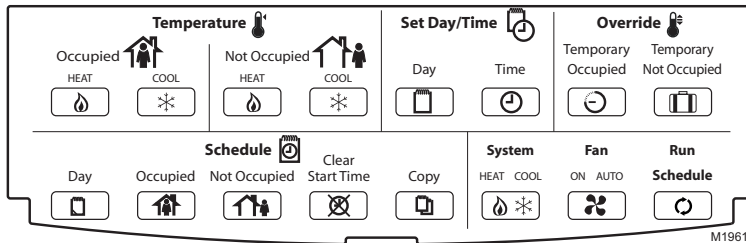

Fig. 5. Thermostat key locations.

## INSTALLER SETUP

For most applications, the thermostat factory settings do not need to be changed. Review the factory settings in Table 2.

NOTE: When power is first applied to the thermostat, the display will show all segments (see Fig. 6).

Table 2. Default setpoints.

Control	Occupied	Not Occupied	Standby
Heating	70°F (21°C)	55°F (13°C)	67°F (19°C)
Cooling	75°F (24°C)	85°F (29°C)	78°F (26°C)

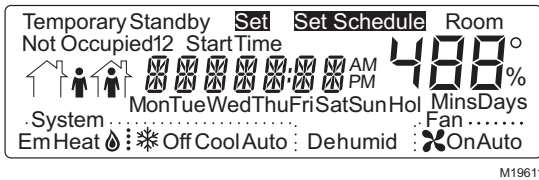

Fig. 6. LCD display of all segments.



### CAUTION

**Possible Equipment Damage.**  
Fan must be running when system is operating.

Heat pump and electric heat systems must be configured correctly to prevent equipment damage caused by the system running without the fan.

## Setup Using Keypad

The installer uses the Installer Setup to customize the thermostat to specific systems. For basic setup functions, the thermostat can be configured using the keypad.

NOTE: The T7350 has serial communications to facilitate use of an installer configuration tool. More advanced features are available using this tool. (Refer to form 63-2605 for details.)

A combination of key presses are required to use the Installer Setup feature:

- To enter the Installer Setup, press and hold both the *Run Schedule* and the *Copy* keys until DEG F (or DEG C) displays.
- To advance to the next Installer Setup number, press **i**.

NOTE: Pressing *Run/Copy* again while in this mode displays the T7350 firmware version number.

- To return to a Setup item, cycle through the options.
- To change a setting, use the up ▲ or down ▼ key.
- To exit the Installer Setup, press *Run Schedule*.
- Display prompts SAV CFG (save configuration).
  - If you want to save the new configuration, use the up ▲ or down ▼ key to change NO to YES before pressing *Run Schedule*.
  - If you want the configuration to remain as it was before starting this change, ensure the display indicates SAV CFG NO and press *Run Schedule*.

NOTE: Installer Setup is automatically exited after five minutes with no key pressed. Upon this automatic exit, all changes are lost.

## Configuration

Limited configuration can be done with the keypad using the Configuration ID. In order to determine the proper codes to use for the Configuration Variables (CnfgID).

NOTE: Spreadsheets of the CnfgID values are available online at <http://customer.honeywell.com>

The PDA T7350 Configuration Tool or the PC Tool LonSpec can also be used as follows:

- Open the PDA Config Tool Application.
- Select the desired configuration.
- On the summary screen, tap CnfgID.
- The PDA determines the proper CnfgID.
- Make note of the values.
- Press both Copy and Run Schedule.
- Tap **i** until C1 appears on the right end of the display.

NOTE: While stepping toward C1, check other items to ensure they are set properly. See Setup Using Keypad section.

- To adjust each variable to match PDA indication:
  - Hold down the up ▲ or down ▼ key to adjust the value quickly.
  - Tap the up ▲ or down ▼ key for fine control.
- Tap **i** to switch to another variable.
- Return to step 8 and repeat the process until all configuration values are set properly.
- To exit the Installer Setup, press *Run Schedule*.
- Display prompts SAV CFG (save configuration).
  - If you want to save the new configuration, use the up ▲ or down ▼ key to change NO to YES before pressing *Run Schedule*.
  - If you want the configuration to remain as it was before starting this change, ensure the display indicates SAV CFG NO and press *Run Schedule*.

## Setting Keypad Lockout

Proper keypad sequences activate the lockout features. To change the keypad lockout state:























- Enter the Installer Setup: press and hold both the *Run Schedule* and the *Copy* keys until DEG F (or DEG C) displays.
- Press **i** until KYLCK displays.
- Use the up ▲ or down ▼ key to change the setting. Options are:
  - 0: No lockout.
  - 1: Lockout all keys except Temporary Occupied, Temporary Not Occupied, up ▲, down ▼ and **i**.
  - 2: Lockout all keys except **i**.

NOTES:

- Options 1 and 2 do not allow adjustments on dehumidification high limit.
- No options lockout special keypress functions. See the Special Functions section for details.

- Once the proper option is chosen, exit Installer Setup by pressing *Run Schedule*.
- Display prompts SAV CFG. If you want to save it, use the up ▲ or down ▼ key to change NO to YES before pressing *Run Schedule* again.

**Table 3. T7350 Key Function Summary.**

Grouping	Button	Definition
Information	Down Arrow 	Lowers setpoint, day, or time. When setting times or temperatures, hold key down to continuously decrease value. Also can make temporary change in temperature setpoint.
	Information 	Obtains information (where humidity "high-limit" can be set), cycles through setup options.
	Up Arrow 	Raises setpoint, day, or time. When setting times or temperatures, hold key down to continuously increase value. Also can make temporary change in temperature setpoint.
Temperature 	Occupied Heat 	Sets Occupied Heat setpoint.
	Occupied Cool 	Sets Occupied Cool setpoint.
	Not Occupied Heat 	Sets Not Occupied Heat setpoint.
	Not Occupied Cool 	Sets Not Occupied Cool setpoint.
Set 	Day 	Sets day of week. Tapping key with 'Set Value' segment on increases current day (same effect as <i>Up Arrow</i> key).
	Time 	Sets time. Tapping key with "Set Value" segment on increases time in one hour increments.
Override 	Temporary Occupied 	Temporary occupied setting for length of time defined by installer. User can modify setpoints.
	Temporary Not Occupied 	Sets holiday length. User selects number of days ("0"- "99"), or "----" for continuous override.
Schedule 	Day 	Selects day schedule to modify. (Used also with copy key.)
	Occupied 	Selects occupied event start times for specified day. Repeatedly press this key to toggle between two occupied events.
	Not Occupied 	Selects not occupied event start times for specified day. Repeatedly press this key to toggle between two not occupied events.
	Clear Start Time 	Clears start time for specified period and day.
	Copy 	Copies schedule from one day to another.
	System 	Selects System Mode. Toggles through Em Heat, Heat, Off, Cool, and Auto.
	Fan 	Selects fan operation mode. Toggles between On and Auto. <sup>a</sup>
	Run Schedule 	Resumes running schedule (cancels Temporary Occupied action, Holiday, and/or Temporary setpoint changes.)

<sup>a</sup> On: Continuous fan operation (occupied and standby). During not occupied periods, fan cycles with call for heat or cool.  
 Auto: Fan cycles with call for heat or cool during all periods. (See Product Data Sheet, form 63-2605, for more details.)

NOTES: The display returns to default screen after pressing Run Schedule (or after a period of time without keypress):

- ten seconds: when returning from temporary setpoint changes, info screen, temp occ, and temp not occ.
- one minute: when returning from setting clock/day.
- ten minutes: when returning from System Checkout.
- five minutes: when returning from all other modes.

## Special Functions

### Restore Factory Configuration (Run/Clear)

**IMPORTANT**

*This operation erases current configuration and restores factory defaults for all configuration, parameters, setpoints and schedules. To regain the old configuration requires device reconfiguration.*

1. Press both *Run Schedule* and *Clear Start Time*.
2. The display gives the option to revert to FAC CFG.
  - a. To restore the factory defaults, press up ▲ or down ▼ until the display indicates YES.
  - b. To cancel this option, ensure the display indicates NO.
3. Press *Run Schedule*.

### Get Factory Schedule (Info/Clear)

Performing this operation reverts the schedules to the factory defaults:

1. Press both *Info* and *Clear Start Time*.
2. The display gives the option to revert to FAC SCH.
  - a. To restore the factory schedule, press up ▲ or down ▼ until the display indicates YES.
  - b. To cancel this option, ensure display indicates NO.
3. Press *Run Schedule*.

### Test Mode (Occupied/Not Occupied/Schedule Day)



## CAUTION

**Possible Equipment Damage.**  
**Equipment damage can result if compressor is cycled too quickly.**

The minimum off time for compressors is bypassed during Test Mode. Equipment damage can occur if the compressor is cycled too quickly.

Use Test Mode to check the thermostat configurations and operation. To start the system test:

1. Press *Schedule Day, Occupied* and *Not Occupied* simultaneously.
2. The display gives the option to TEST.
  - a. To enter test mode, press up ▲ or down ▼ until the display indicates IN TEST.
  - b. To cancel this option, ensure display indicates NO TEST.
3. Press *Run Schedule*.

**NOTES:**

- To verify whether or not the system test is still active, repeat the above process.
- The system test times out after ten minutes with no key pressed.

### Save User Schedule (Info/Copy)

Performing this operation saves the current schedule (including holidays) to memory, overwriting the old saved schedule:

1. Press both *Info* and *Copy*.
2. The display gives the option to revert to SAV SHD.
  - a. To save the current schedule, press up ▲ or down ▼ until the display indicates YES.
  - b. To cancel this option, ensure display indicates NO.
3. Press *Run Schedule*.

### Get User Schedule (Info/Run)

Getting the user schedule restores the schedule (including holidays) from saved memory, overwriting the schedule currently in use:

1. Press both *Run Schedule* and *Info*.
2. The display gives the option to GET SHD.
  - a. To retrieve the saved schedule, press up ▲ or down ▼ until the display indicates YES.
  - b. To cancel this option, ensure display indicates NO.
3. Press *Run Schedule*.

## TROUBLESHOOTING GUIDE (TABLE 4)

Table 4. Troubleshooting Information.

Symptom	Possible Cause	Action
Display will not come on.	Thermostat is not being powered.	Check that X terminal is connected to the system transformer. Check for 24 Vac between X and RH terminals. If missing 24 Vac: <ul style="list-style-type: none"> <li>• Check if circuit breaker is tripped; if so, reset circuit breaker.</li> <li>• Check if system fuse is blown; if so, replace fuse.</li> <li>• Check if the HVAC equipment power switch is in the Off position; if so, set to the On position.</li> <li>• Check wiring between thermostat and HVAC equipment. Replace broken wires and tighten loose connections.</li> </ul> If 24 Vac is present, proceed with troubleshooting.
Temperature display is incorrect.	Room temperature display has been recalibrated.	Use PDA configuration software to recalibrate as desired.
	Thermostat is configured for °F or °C display.	Press both <i>Run Schedule</i> and <i>Copy</i> , then reconfigure the display.
	Bad thermostat location.	Relocate the thermostat.
	Display shows three dashes and a degree sign (all systems shut down).	T7350 is set for remote sensing and sensor is missing or circuit is either open or shorted.

**Table 4. Troubleshooting Information. (Continued)**

Symptom	Possible Cause	Action
Temperature settings will not change. (Example: Cannot set heating higher or cooling lower.)	Upper or lower temperature limits were reached.	Check the temperature setpoints: <ul style="list-style-type: none"> <li>• Heating limits are 40 to 90°F (7 to 31°C)</li> <li>• Cooling limits are 45 to 99°F (9 to 37°C)</li> </ul>
	Occupied setpoint temperature range stops were configured.	Using a PDA, check setpoint stops. If necessary, reconfigure the stop(s).
	Keypad is locked. When a locked key is pressed, LOCKED appears momentarily on the LCD.	<ul style="list-style-type: none"> <li>• Use PDA (Set, Display) to unlock keypad.</li> <li>• Press both <i>Run Schedule</i> and <i>Copy</i>, then change keypad lock level.</li> </ul>
Room temperature is out of control.	Remote temperature sensing is not working.	Check all remote sensors.
Heat will not come on.	No power to the thermostat.	Check that X terminal is connected to the system transformer. Check for 24 Vac between X and RH terminals. If missing 24 Vac: <ul style="list-style-type: none"> <li>• Check if circuit breaker is tripped; if so, reset circuit breaker.</li> <li>• Check if system fuse is blown; if so, replace fuse.</li> <li>• Check if the HVAC equipment power switch is in the Off position; if so, set to the On position.</li> <li>• Check wiring between thermostat and HVAC equipment. Replace broken wires and tighten loose connections.</li> </ul> If 24 Vac is present, proceed with troubleshooting.
	Thermostat minimum off time is activated.	Wait up to five minutes for the system to respond. Use PDA to configure heating response.
	System selection is set to Off or Cool.	Set system selection to Heat or Auto.
Cooling will not come on.	No power to the thermostat.	Check that X terminal is connected to the system transformer. Check for 24 Vac between X and RH terminals. If missing 24 Vac: <ul style="list-style-type: none"> <li>• Check if circuit breaker is tripped; if so, reset circuit breaker.</li> <li>• Check if system fuse is blown; if so, replace fuse.</li> <li>• Check if the HVAC equipment power switch is in the Off position; if so, set to the On position.</li> </ul> Check wiring between thermostat and HVAC equipment. Replace broken wires and tighten loose connections. If 24 Vac is present, proceed with troubleshooting.
	Thermostat minimum off time is activated.	Wait up to five minutes for the system to respond. Use PDA to configure cooling response.
	System selection is set to Off or Heat.	Set system selection to Cool or Auto.
System indicator (flame: heat, snowflake: cool) is displayed, but no warm or cool air is coming from the registers.	The call for heat or cool is not yet given.	Check if any stage indicators (dots next to the system indicator) are displayed. With no display of stage indicators, no call for cool/heat is yet given. For T7350M models <i>only</i> : Check the information screens. A MODHEAT or MODCOOL percentage of zero indicates a signal of 4 mA from the given terminal.
	Conventional heating equipment turns the fan on only after the furnace has warmed to a setpoint.	Wait one minute after seeing the on indicator and then check the registers.
	Heating or cooling equipment is not operating.	Verify operation of heating or cooling equipment in self-test.

## S89E,F Direct Spark Ignition Control Module

### PRODUCT DATA



### APPLICATION

The Honeywell S89E,F Direct Spark Ignition Control Modules control the ignition sequence and gas control operation in direct spark systems used primarily on gas-fired atmospheric and power burners in residential furnaces and heating appliances.

### FEATURES

- Requires separate 120 Vac spark generator.
- S89E has 10-second maximum delay for safe start check before ignition.
- S89F has 38-second maximum delay for safe start check plus valve on delay before ignition.
- Available with 4 or 11 second (nominal) lockout timing.
- 100 percent shutoff for use with all heating gases.
- Ambient temperature rating is -40°F to +175°F (-40°C to +80°C).
- Separate electrodes for spark ignition and flame sensing.
- Uses Honeywell or any other 2A or less dual valve combination gas control designed for Direct Spark Ignition (DSI) applications.
- Locks out system after trial for ignition if main burner fails to ignite.
- Flame rectification principle used to monitor flame; false flame signals resulting from short to ground results in safety shutdown.
- After safety shutdown, S89E and F can be reset from the thermostat.

### Contents

Application .....	1
Features .....	1
Specifications .....	2
Ordering Information .....	2
Installation .....	3
Wiring .....	4
Start-Up and Checkout .....	4
Operation .....	6
Troubleshooting .....	7



## SPECIFICATIONS

### IMPORTANT

The specifications given in this publication do not include normal manufacturing tolerances. Therefore, this unit may not match the listed specifications exactly. Also, this product is tested and calibrated under closely controlled conditions, and some minor differences in performance can be expected if those conditions are changed.

### Models:

S89 Direct Spark Ignition Control Modules. Provide electronic control of direct spark ignition system on gas-fired atmospheric and power burners.

S89E: 10-second maximum delay for safe start check.

S89F: 38-second maximum delay for safe start check plus valve on delay.

Complete DSI system also includes:

120 Vac Spark Generator with 1.5A or less current draw.

Q347 Spark Igniter or equivalent.

Q354 Flame Sensor or equivalent.

VR845, VR854, VR8450, or VR8305 Combination Gas

Controls or any dual valve rated 2A or less and designed for DSI applications.

24 to 30 Vac Thermostat.

High Temperature Limit Controller.

24V Transformer. See Table 1 for VA rating.

### Electrical Ratings:

Power supply: Requires two power supply connections—24 and 120 Vac, 50/60 Hz.

Current at 24V input: 2.2A maximum.

Valve Contacts: 2.0A maximum run, 20A maximum inrush at 24 Vac.

Spark Generator Relay Contacts: 1.5A at 120 Vac, 50/60 Hz.

**Transformer Rating:** See Table 1.

**Thermostat Heat Anticipator Setting:** 0.2A plus gas control current.

### Delay Timing:

S89E: Safe Start Check—10 seconds maximum.

S89F: Safe Start Check plus Valve On Delay—38 seconds maximum.

Table 1. Transformer Rating.

S89 Current (in Amperes)	Gas Control Current (In Amperes)	Transformer VA Rating Required	Transformer Model No.
0.2	0 to 0.6	20	AT20A or AT120A
0.2	0.6 to 1.0	30	AT72D or AT140A
0.2	1.0 to 1.4	40	AT72D or AT140A
0.2	1.4 to 2.0	50	AT87A or AT150A

**Safety Lockout Timing:** 4 or 11 seconds nominal. Ignition is on during approximately the first 80 percent of lockout timing and off during the last 20 percent for flame proving. Specify lockout timing when ordering.

**Flame Failure Response Time:** 2 seconds maximum with 2.5  $\mu$ A flame current.

**Flame Current Signal:** 0.8  $\mu$ A minimum.

**Ambient Temperature Range:** -40°F to +175°F (-40°C to +80°C).

### Wiring Connections:

24 Vac—3/16 in. quick-connects.

120 Vac—12 in. (305 mm) color-coded leadwires.

**Sensing Lead:** Up to 36 in. (0.9m). Insulation must be rated for 100 megohm resistance between wire and ground.

**Mounting:** Mounts in any position.

**Dimensions:** See Fig. 1.

## ORDERING INFORMATION

When purchasing replacement and modernization products from your TRADELINE® wholesaler or distributor, refer to the TRADELINE® Catalog or price sheets for complete ordering number.

If you have additional questions, need further information, or would like to comment on our products or services, please write or phone:

1. Your local Honeywell Automation and Control Products Sales Office (check white pages of your phone directory).
2. Honeywell Customer Care  
1885 Douglas Drive North  
Minneapolis, Minnesota 55422-4386

In Canada—Honeywell Limited/Honeywell Limitée, 35 Dynamic Drive, Scarborough, Ontario M1V 4Z9.

International Sales and Service Offices in all principal cities of the world. Manufacturing in Australia, Canada, Finland, France, Germany, Japan, Mexico, Netherlands, Spain, Taiwan, United Kingdom, U.S.A.

**Approvals:**

Underwriters Laboratories Inc. Component Recognized: File No. MP268, Guide No. MCCZ2.

CSA International Certified: 158158-1047805.

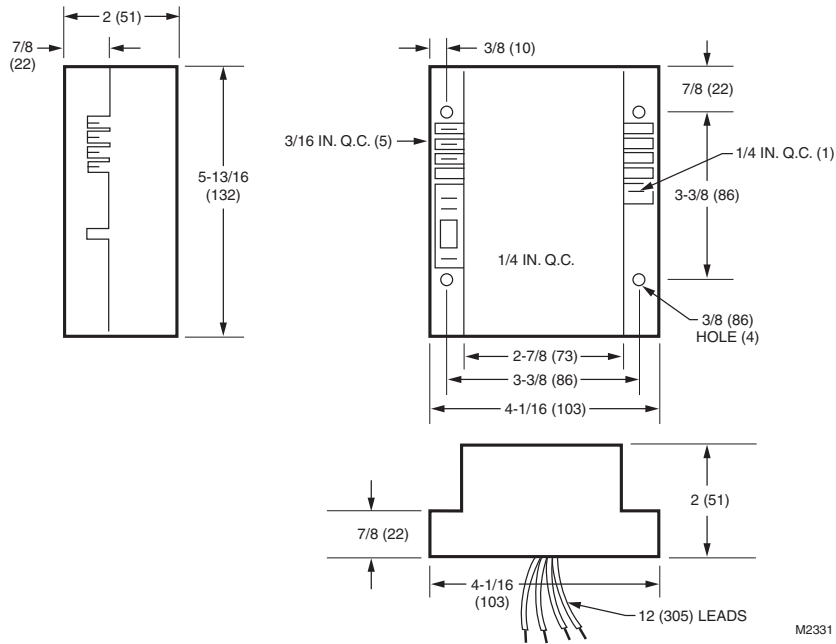

Fig. 1. S89 dimensions in in. (mm).

**INSTALLATION**

**When Installing This Product...**

1. Read these instructions carefully. Failure to follow them could damage the product or cause a hazardous condition.
2. Check the ratings given in the instructions and on the product to make sure the product is suitable for your application.
3. Installer must be a trained, experienced service technician.
4. After installation is complete, check out product operation as provided in these instructions.

**⚠ WARNING**

**Fire or Explosion Hazard.**

**Can cause severe injury, death or property damage.**

1. Disconnect power supply before wiring to avoid electrical shock, explosion, or equipment damage.
2. If a new gas control is being installed, turn off gas supply before starting installation. Conduct Gas Leak Test after gas control is installed.
3. In an LP gas installation, remember that LP gas is heavier than air and will not vent upward naturally. Do not operate electric switches, lights, or appliances until you are sure that work area is free of gas.
4. Never install an S89 where water can flood, drip, or condense on the device. It can malfunction if it gets wet.
5. Never try to use a device that has been damp or wet—replace it.
6. If the control might be exposed to water or moisture, install it in a suitable waterproof enclosure.
7. Any replacement S89 must have the same or shorter lockout time *and* the same or longer delay timing as the original control.

**Replacement Application Requirements**

If this is a replacement application, follow the appliance manufacturer instructions, if available. The manufacturer usually provides wiring diagrams, start-up and checkout

instructions, and service procedures for their appliance. If the manufacturer instructions are not available, use the general guidelines that follow.

## Mount the S89

Select a convenient location on the burner or furnace chassis or cabinet, protected from moisture due to splashing, dripping, or condensation. Allow room to easily reach the S89 terminals for wiring and servicing. Do not exceed the ratings given in the Specifications section.

The S89 may be mounted in any position. See Fig. 1 for mounting dimensions. Mount with 1 in. (25 mm) long, no. 6-32 machine screws or no. 8 sheet metal screws. Fasten securely.

## Mount Auxiliary Controls

Mount the spark generator, igniter, flame sensor, thermostat, transformer, gas control, and any other auxiliary controls according to the control manufacturer instructions.

## WIRING

### CAUTION

#### Equipment Damage Hazard.

#### Can cause equipment malfunction or damage.

1. The sensor leadwire must be no more than 3 ft (0.9m) long. Do not allow the wire to touch grounded metal surfaces.
2. A common ground is required for the S89, the spark igniter and the main burner. The 24V (GND) terminal internally grounds one side of the transformer. Auxiliary controls or limits must be in the ungrounded leg.

### WARNING

#### Electrical Shock Hazard.

#### Can cause severe injury, death or property damage.

Disconnect the power supply before beginning wiring. More than one disconnect may be required.

Use wiring diagrams and instructions provided by the appliance manufacturer, if available. Otherwise, follow the general procedures and diagrams outlined below.

All wiring must comply with all applicable electrical codes and ordinances.

1. Make sure the transformer has adequate power (VA) rating. See Table 1 in Specifications section.
2. If you are replacing an S89 that was used with an external valve on delay timer, you must disconnect the external timer and use an S89F to provide the delay function. External timers cannot be used with either S89E or S89F controllers because the safety circuit in

the controls may repeatedly set the timer to zero, preventing burner start. Always disconnect the external timer when using an S89E or F. To disconnect the timer:

- a. Turn off power.
  - b. Cut the two leadwires at the external timer.
  - c. Strip the ends of the wires 1/2 in. (13 mm) and connect with a solderless connector.
  - d. Restore power.
3. Wire system components and S89 as shown in Fig. 2 and 3. Refer to appliance manufacturer instructions for connections to other auxiliary controls.
  4. Make sure the L1 (Hot) and L2 (Ground) leads are connected to the right leads. If they are reversed, the S89 will not detect the flame and will go into safety lockout.
  5. Connect spark igniter, flame sensor, main burner, and S89 to a common ground. Use thermoplastic insulated wire with a minimum rating of 221°F (105°C) for the ground wire. Connect the ground wire as follows:
    - a. Connect one end of the ground wire to the quick-connect GND (burner) terminal on the S89, using a 1/4 in. (6 mm) quick-connect (AMP 41772 or equivalent).
    - b. Strip the other end of the wire and fasten it under the igniter bracket mounting screw.
    - c. If necessary, install a shield to protect the wire from radiant heat generated by the burner.
    - d. The burner serves as the common ground. If metal-to-metal contact between the burner and the appliance cabinet is poor, run a lead from the burner to the cabinet. The cabinet must be earth-grounded.

## START-UP AND CHECKOUT

If this is a replacement application, refer to the specific instructions provided by the heating appliance manufacturer (if available). Also, since the auxiliary controls used on any system may differ, refer to the control manufacturer instructions for start-up and checkout procedures for other system components.

## Perform Gas Leak Test

### WARNING

#### Fire or Explosion Hazard.

#### Can cause severe injury, death or property damage.

1. Never use a flame to check for gas leaks, only a soap and water solution.
2. Test for gas leaks whenever work is done on a gas system.
3. Soap and water must not touch the S89.

With the main burner in operation, paint the pipe joints and gas control gasket edges with a rich soap and water solution. Bubbles indicate a gas leak. To stop the leak, tighten joints and screws, or replace the gas control. *Never* use a flame to check for gas leaks.

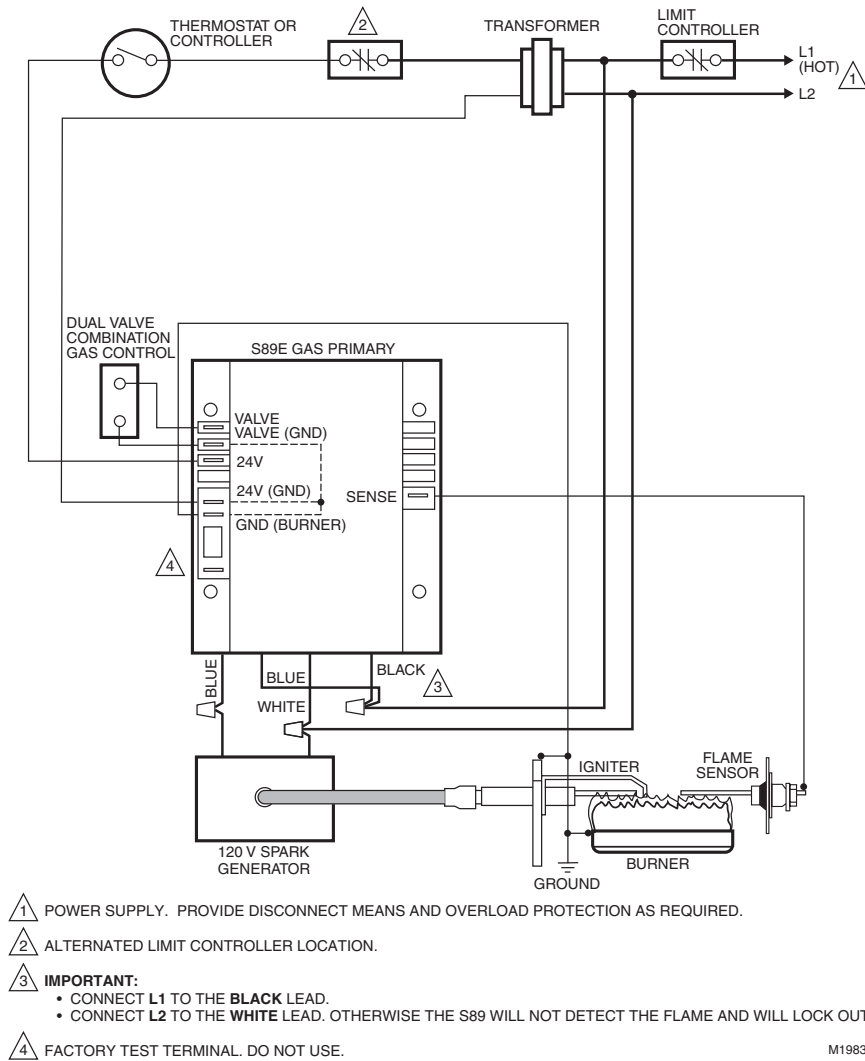

Fig. 2. S89E typical hookup in direct spark control system. See Fig. 8 for control system ladder diagram.

## Check Out S89

NOTE: If operation is not as described below, refer to Troubleshooting section.

1. Set thermostat to call for heat.
2. Turn on power and gas supply.
3. Igniter starts to spark and gas control opens after safe start check (S89E: 10 seconds maximum) or safe start check plus valve on delay (S89F: 30 seconds minimum).
4. Main burner lights while igniter is on.

NOTE: If the gas control has been replaced or serviced, lightoff may be unsatisfactory until air has been purged from the gas line or the gas input and combustion air have been adjusted (see appliance manufacturer instructions).

5. Turn off gas supply.
6. Gas control closes.
7. The module begins the safe start check (S89E: 10 seconds maximum) or safe start check plus valve on delay (30 seconds minimum) after which the igniter starts and gas control opens.
8. Time system until gas control closes. S89 is now in safety lockout. The lockout time should be within the specifications in Table 2.
9. Open gas supply. System remains off and no gas flows to the main burner.

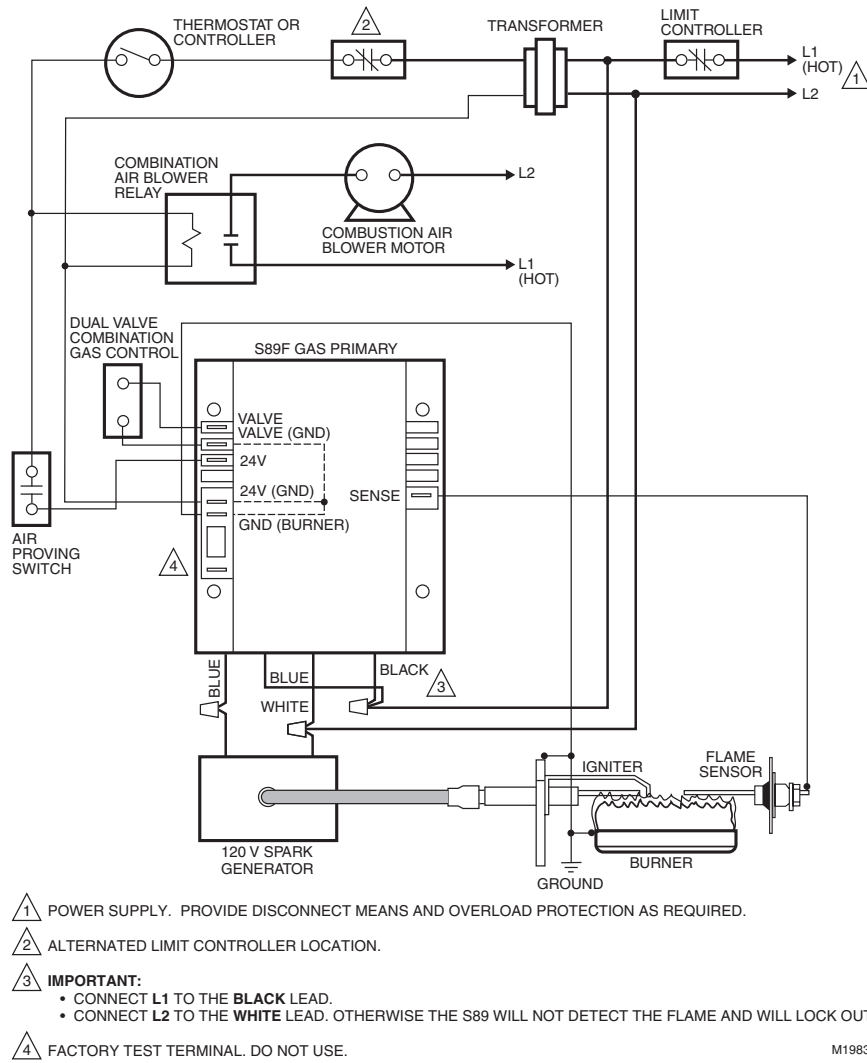

Fig. 3. S89F typical hookup in direct spark control system. See Fig. 9 for control system ladder diagram.

10. Turn off gas supply.
11. Gas control closes.
12. The module begins the safe start check (S89E: 10 seconds maximum) or safe start check plus valve on delay (38 seconds maximum) after which the igniter starts and gas control opens.
13. Time system until gas control closes. S89 is now in safety lockout. The lockout time should be within the specifications in Table 2.
14. Open gas supply. System remains off and no gas flows to the main burner.

Table 2. S89 Lockout Times.

Lockout Time Shown on S89 Module	Safety Lockout Time	
	Minimum	Maximum
4 seconds	3.0 seconds	5.5 seconds
11 seconds	8.0 seconds	15.0 seconds

### Resetting S89 After Safety Lockout

Once the S89 locks out, it must be reset before the system will operate. To reset, set the thermostat below room temperature, wait at least 45 seconds, then turn the thermostat up to call for heat. The system should start normally. If adjusting the thermostat does not reset the S89, turn off power to the appliance for 45 seconds and then turn it on.

### Final Checkout

With power and gas supply on, set thermostat to call for heat and observe operation through at least one complete cycle to make certain that all controls are operating safely.

### OPERATION

The S89 is powered by a 24V transformer. It operates in response to a call for heat from the thermostat.

On every call for heat, the S89 performs a safe start check. If a flame or a flame simulating condition is present, the S89 locks out without starting the igniter and must be reset.

Following the safe start check and, on the S89F, a valve on delay period, the S89 spark generator contacts close to energize the spark generator and the igniter. At the same time the gas control, powered through the gas valve relay contacts in the S89, opens so gas can flow to the burner. The igniter is on during approximately the first 80 percent of the ignition, or lockout timing, period. During the balance of the lockout timing period, the ignition is off and the flame sensor attempts to prove the flame. The flame is proved when current from the flame sensor through the burner flame to ground reaches 0.8  $\mu$ A dc.

*If flame is proved*, the gas control remains open and the burner on until the call for heat ends.

*If flame is not proved*, the gas control closes and the system is locked out until the S89 is reset.

*If flame is lost after being proved*, the S89 will close the gas control, perform a safe start check, and, on the S89F, valve on delay, then return ignition as described above.

The S89 is reset by turning the thermostat below room temperature or removing power to the system for 45 seconds.

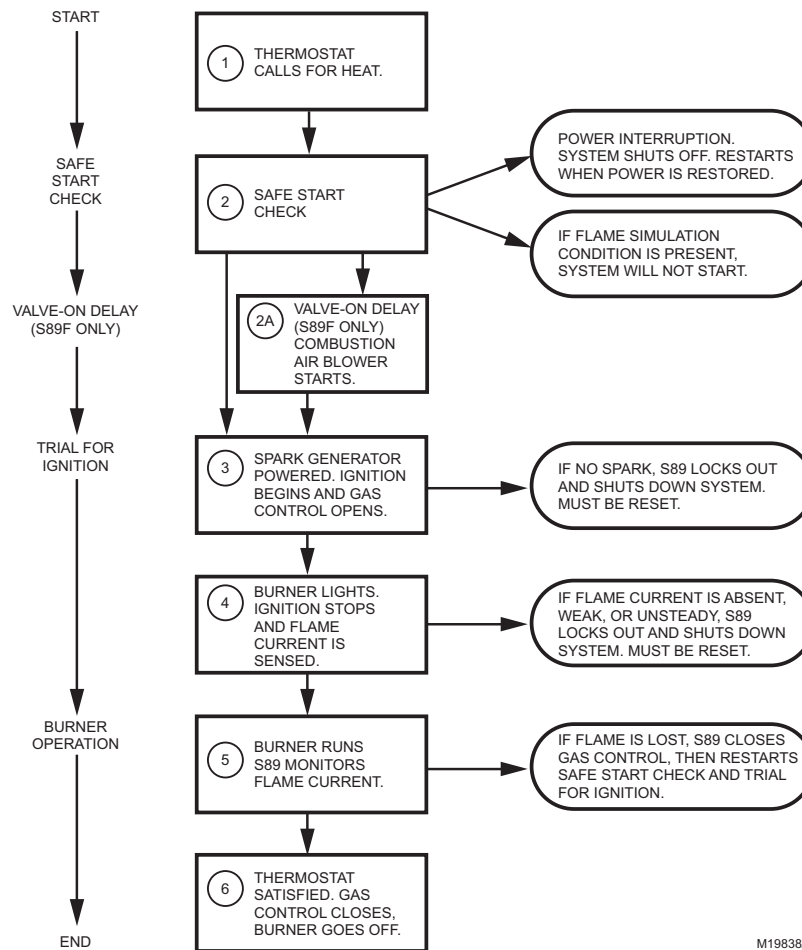

Fig. 4. Normal sequence of operation.

## TROUBLESHOOTING

### WARNING

**Fire or Explosion Hazard.**  
Can cause severe injury, death, or property damage.

Any replacement S89 must have the same or shorter lockout timing *and* the same or longer delay timing as the original control.

**IMPORTANT**

1. The following service procedures are provided as a general guide. Follow appliance manufacturer service instructions, if available.
2. All meter readings must be taken within the trial for ignition period. Once the ignition period ends, the system must be reset by setting the thermostat down for at least 45 seconds before continuing.
3. If any component does not function properly, make sure it is correctly installed and wired before replacing it.
4. The ignition module cannot be repaired. If it malfunctions, it must be replaced.
5. Only trained, experienced service technicians should service direct spark ignition systems.

Before beginning troubleshooting, review the normal operating sequence of the S89. See the Operation section. Then follow the steps in Fig. 5 to identify the source of the problem. Some steps are explained in greater detail below.

Besides standard hand tools, you will need the following to complete the troubleshooting:

1. Honeywell W136 Test Meter or equivalent.
2. Test lead: a length of ignition cable or other heavily insulated wire with both ends stripped 1/2 in. (13 mm).

**Check Ignition System Grounding**

Nuisance shutdowns are often caused by a poor or erratic ground.

A common ground is required for the module, igniter, flame sensor and main burner.

1. Check for good metal-to-metal contact between the igniter bracket and the main burner.
2. Check the ground lead from the GND (Burner) terminal on the module to the igniter bracket. Make sure connections are clean and tight. If the wire is damaged or deteriorated, replace it with no. 14 to 18 gauge, moisture-resistant, thermoplastic insulated wire with a 221°F (105°C) minimum rating. Use a shield if necessary to protect the ground wire from radiant heat.

**Check Spark Ignition Circuit**

The S89 spark generator relay switches 120 Vac to the remote-mounted spark generator, which, in turn, powers the spark igniter at the burner. Check as follows:

1. Shut off gas supply to the gas control.
2. Disconnect the ignition cable at the spark generator stud terminal.

3. Set the thermostat to call for heat.
4. Reset the S89 by removing power to the module for 45 seconds.

**⚠ WARNING**

**Electrical Shock Hazard.**

**Can cause severe injury, death, or property damage.**

In the next step, *do not touch* either the stripped end of the test lead or the stud terminal.

5. Restore power. Before the S89 locks out, touch one end of the test lead firmly to the S89 GND terminal. Do not remove the existing ground lead.
6. Slowly move the other end of the test lead toward the stud terminal on the spark generator until sparking stops.
7. Slowly pull the wire away from the stud terminal and note the size of the gap when sparking stops.
8. Follow instructions in Table 3.

**Table 3. Spark Ignition Troubleshooting.**

<b>If the Gap Was:</b>	<b>Then:</b>
1/8 in. (3 mm) or more	Generator output voltage is okay.
Less than 1/8 in. (3 mm) or no spark	Check for 120 Vac at the spark generator terminals. If okay, replace the spark generator.

**Check Flame Sensor and Igniter**

1. Make sure burner flame is capable of providing a good rectification signal. See Fig. 7.
2. Make sure about 3/4 to 1 in. (19 to 25 mm) of the flame sensor is continuously immersed in the flame for best flame signal. See Fig. 7. Bend the bracket or flame sensor, or relocate the sensor as necessary. Do *not* relocate the igniter.
3. Make sure flame does not touch sensor or ignitor ceramic insulator and that insulators are below the flame. Excessive heat (over 1000°F [538°C]) will cause short to ground. Move sensor to cooler location or shield insulators if excessive heat is suspected. Do *not* relocate the igniter.
4. Check for cracked igniter or sensor ceramic insulator, which can cause short to ground, and replace unit if necessary.
5. Make sure electrical connections are clean and tight.
6. Replace damaged wire with moisture-resistant no. 18 wire rated for continuous duty up to 221°F (105°C).

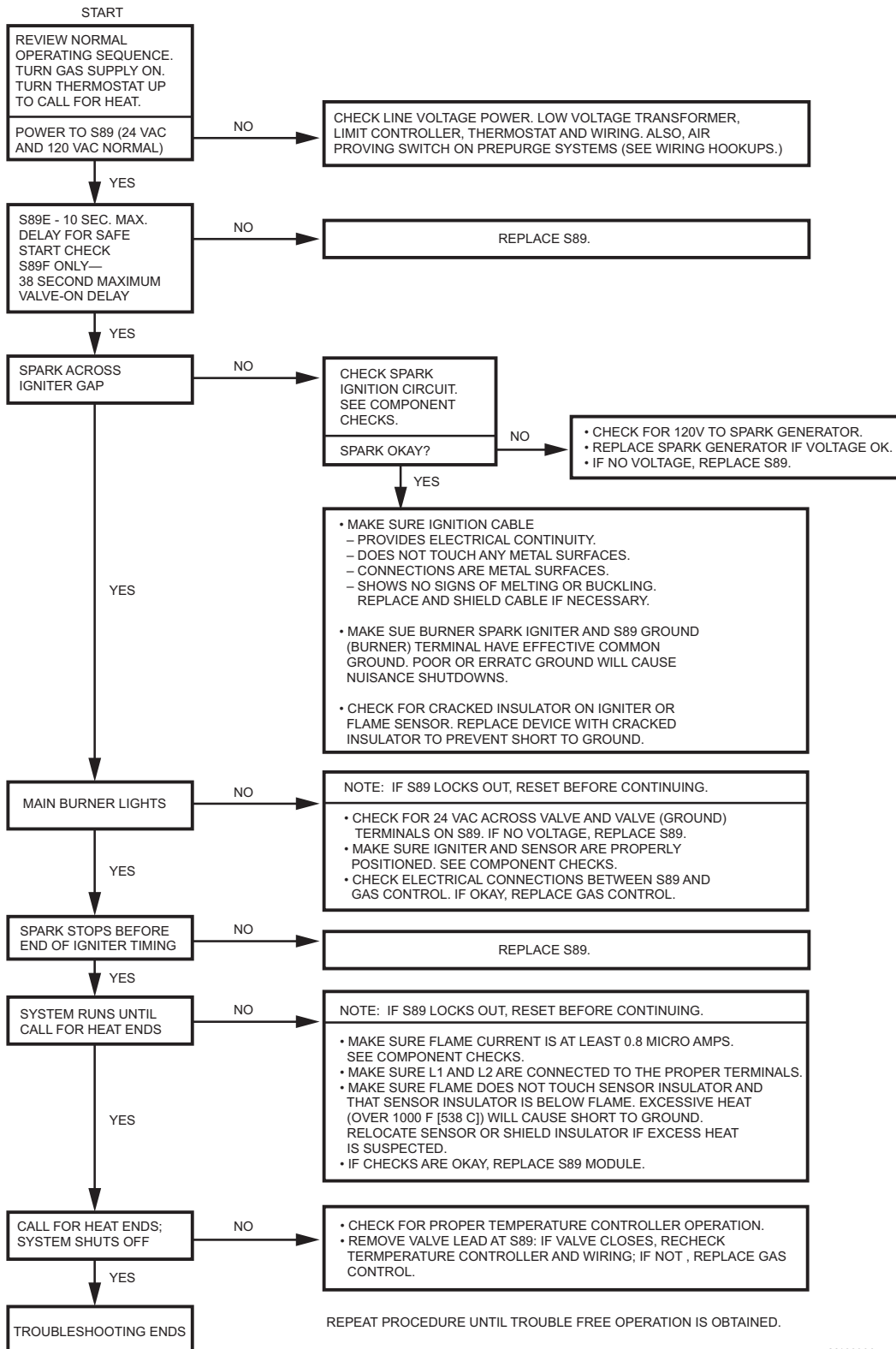

M19839A

Fig. 5. Troubleshooting S89E,F.

## Measure Flame Current

The S89 provides ac power to the flame sensor which the flame rectifies to direct current. If the flame signal back to the S89 is less than 0.8  $\mu\text{A}$ , the S89 will shut down the system.

To measure the flame current:

1. Connect a meter, set to the dc microammeter scale, in series with the flame sensor as shown in Fig. 6. Use the Honeywell W136 Test Meter or equivalent. Connect the meter as follows:
  - a. Disconnect the sensor lead at the S89.
  - b. Connect the red (positive) meter lead to the S89 sense terminal.
  - c. Connect the black (negative) meter lead to the free end of the sensor lead.
2. Restart the system and read the meter. The flame sensor current must be at least 0.8  $\mu\text{A}$  and steady.

3. If the meter reads less than 0.8  $\mu\text{A}$  or reading is unsteady, recheck points under Check Flame Sensor and Igniter, above.

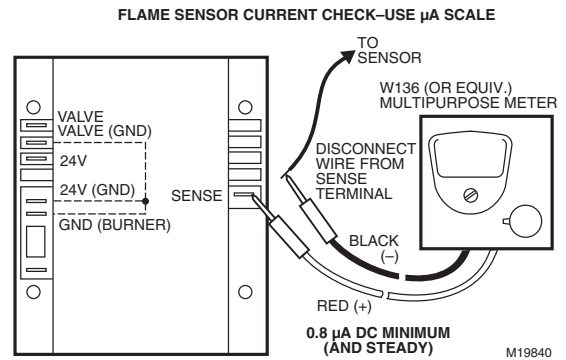

**Fig. 6. S89 flame current measurement.**

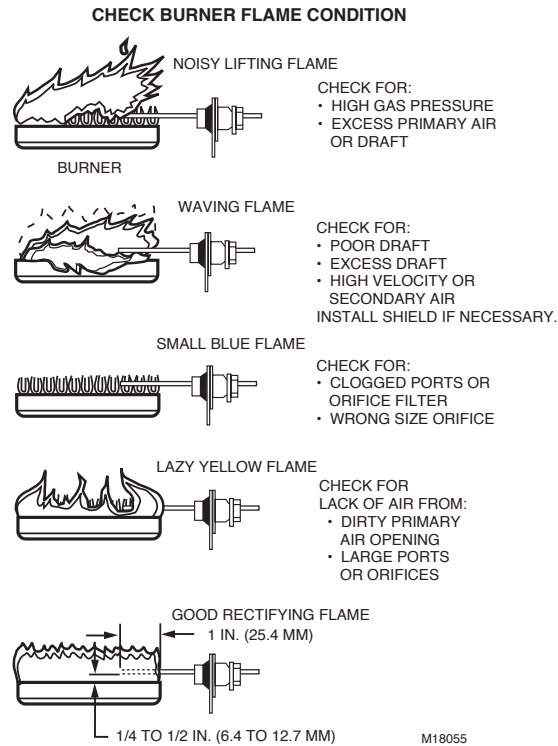

**Fig. 7. Check burner flame condition.**

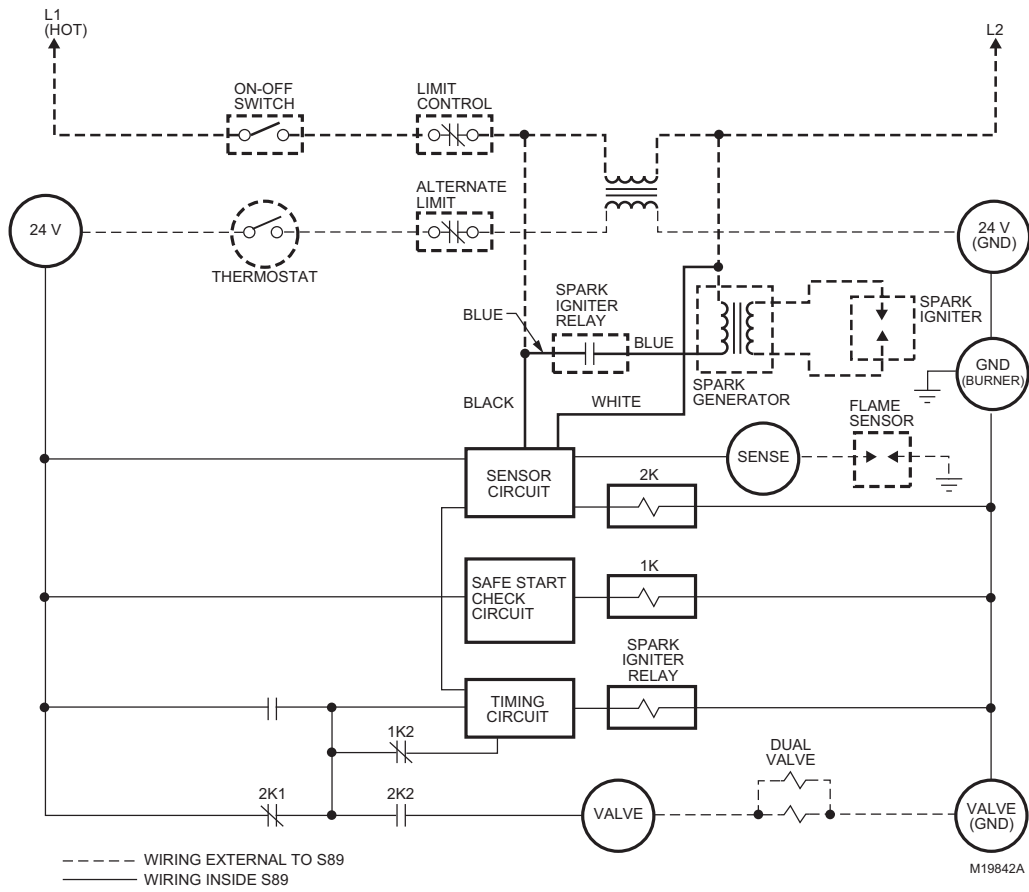

Fig. 8. S89E simplified control system schematic.



## SECTION VII - TROUBLESHOOTING THE BURNER

### NUISANCE LOCKOUTS/FLAME SENSING PROBLEMS - HSG200 & HSG400 GAS BURNERS

Wayne's HSG series direct spark ignition (DSI) gas burners prove flame through the process of flame rectification. Flame rectification is achieved by placing a small voltage on the flame sensing probe. When the probe is surrounded by flame, the voltage on the probe "leaks" to ground through the flame, resulting in an electrical current. This current is interpreted by the ignition control as the presence of flame.

One of the most common problems with gas appliances utilizing this type of electronic flame sensing system is the "nuisance lockout". Lockouts are not generally due to the burner failing to ignite, but rather simply the failure of the system to sense the establishment of flame. Should this situation exist for a period of time longer than the ignition control's state lockout timing, the control will shut down or go into permanent lockout. The only way to get the burner to recycle is to break, and then reinstate power to the burner.

**The following situations can lead to flame sensing problems and can be checked without disassembling the burner:**

- The burner is not properly grounded to "earth ground" on the line voltage.
- The ignition control is not properly grounded to the burner itself. Using an ohmmeter, check the wire attached to both parts for good contact and continuity.
- The burner ignition control is polarity sensitive. The polarity of the incoming line voltage may be reversed. Verify that black and white wires are hot and neutral respectively, and that they are connected to the corresponding black and white wires on the burner.

**The remaining checks and/or adjustments require removal of the gas train:**

- The connections from the "SENSE" terminal of the ignition control to the end of the flamerod may be broken at some point. Check all quick connect terminations and connections. Check the continuity with an ohmmeter while flexing wires to assure no hidden conductor breakage exists. If replaced, wiring must be of equal, or heavier gauge and equal, or better temperature rating.
- The flamerod probe may be grounded out. Assure that the flamerod probe is not touching the burner head. The probe should be positioned in the center of the clearance groove on the outer edge of the

burner head with approximately 1/16" (1.5875mm) clearance from the head. The probe must not be positioned too far away from the head as this may result in grounding out of the probe against the inside surface of the air tube.

- The flamerod probe should be free of soot and creosote. Deposits may insulate the probe, leading it not to pass the electrical charge to the flame. The probe can be cleaned with steel wool, emery paper or fine sandpaper. NOTE: This is the leading cause of nuisance lockouts in dual-fuel wood/gas fired appliances.
- The flamerod probe may be burned away. Check it against dimensions on the ELECTRODE AND FLAMEROD PROBE SETTINGS drawing.
- The dimensional location of the flamerod probe may be incorrect, or the probe may be bent out of shape. Check it against dimensions on the ELECTRODE AND FLAMEROD PROBE SETTINGS drawing and adjust if necessary.
- The spark electrode gap may be incorrect, resulting in no spark or an inadequate spark that will not ignite the gas properly. Check the electrode gap against the ELECTRODE AND FLAMEROD PROBE SETTINGS drawing and adjust if required.
- The high tension lead conductor from the ignition transformer to the tip of the spark electrode may be broken, preventing the high voltage current from getting to the electrode tip. Check all connections thoroughly and/or check to continuity of the lead wire assembly with an ohmmeter.

Once all of the items listed previously have been carefully checked and corrected if necessary, reinsert the gas train assembly into the burner. **NOTE:** Be careful not to bend the air proving switch sail arm (if so equipped) or accidentally reposition either the flamerod probe or electrode during reinstallation of the gas train assembly.

If, after all of the above listed items have been carefully checked, the burner still fails to work, it is due to one or more of the following problems:

1. Unit sparks and fires but will not stay lit. Ignition control module is malfunctioning and must be replaced.
2. Unit does not spark. Ignition transformer is bad and must be replaced.

## FLUE GAS ANALYSIS

This curve correlates the relative values of  $O_2$  and  $CO_2$  for the fuels listed, as well as the percentage of excess air at given  $O_2$  and  $CO_2$  values.

Example: Following the dotted line on the vertical axis from 4%  $O_2$  to curve H and the dotted line on the horizontal axis to the left, the % excess air column shows that 4%  $O_2$  equals 25% excess air.

Following the vertical dotted line axis again from curve H to fuel A (Natural Gas) and the horizontal axis to the left, the %  $CO_2$  column shows that 4%  $O_2$  and 25% excess air correlate to 9-1/2%  $CO_2$  for Natural Gas.

Again following the 4%  $O_2$  vertical axis to fuel line E (#2 Fuel Oil ) and to the left to the  $CO_2$  column shows that 4%  $O_2$  and 25% excess air correlate to 12-1/2 %  $CO_2$  on #2 Fuel Oil.

This chart can be used to determine required  $CO_2$  or  $O_2$  values (and therefore equivalent BTU input values) for the secondary fuel when the burner has been properly adjusted for the primary fuel inputs.

Table 13

**$CO_2$  -  $O_2$  Ratio Curves for Fuel Oils and Gases**

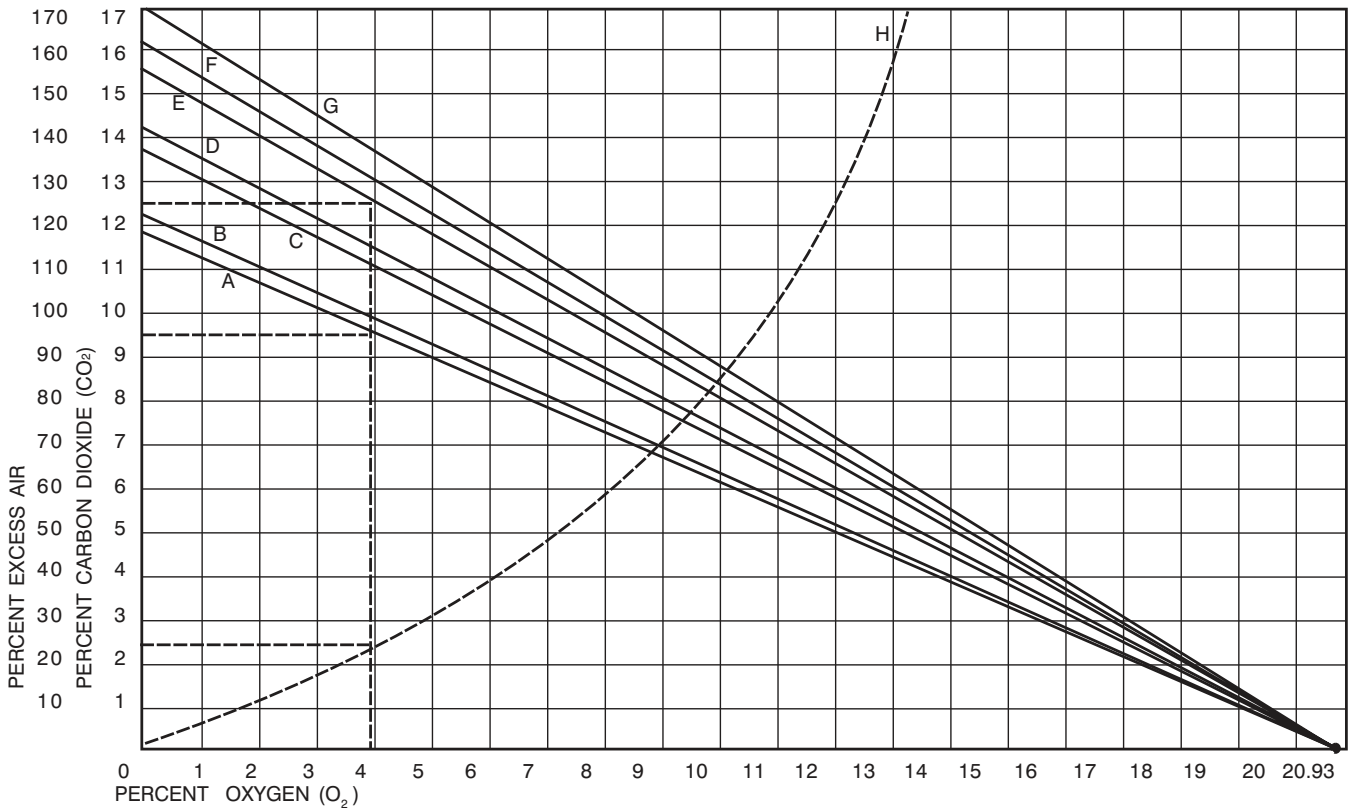

CURVE	FUEL	MAXIMUM $CO_2$ %
A	Natural Gas	11.7
B	Natural Gas	12.1
C	Propane	12.1
D	Butane	14.0

CURVE	FUEL	MAXIMUM $CO_2$ %
E	#2 Fuel Oil	15.2
F	#5 Fuel Oil	16.0
G	#6 Fuel Oil	16.9
H	Excess Air vs. $O_2$	

## SECTION VIII - SERVICING THE BURNER

This section is intended as a guide in making some repairs and adjustments to the power burner. Many of the repairs will require the service of a skilled heating service technician. For more information refer to the burner I.O.M.

### HSG 400 Burners

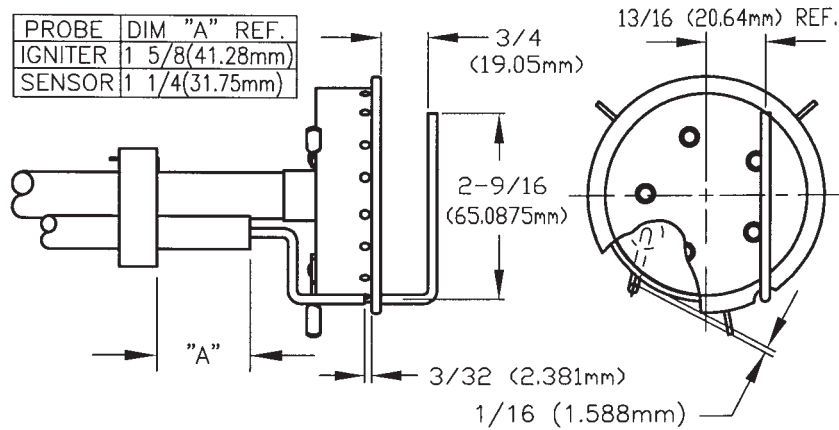

**Figure 13**

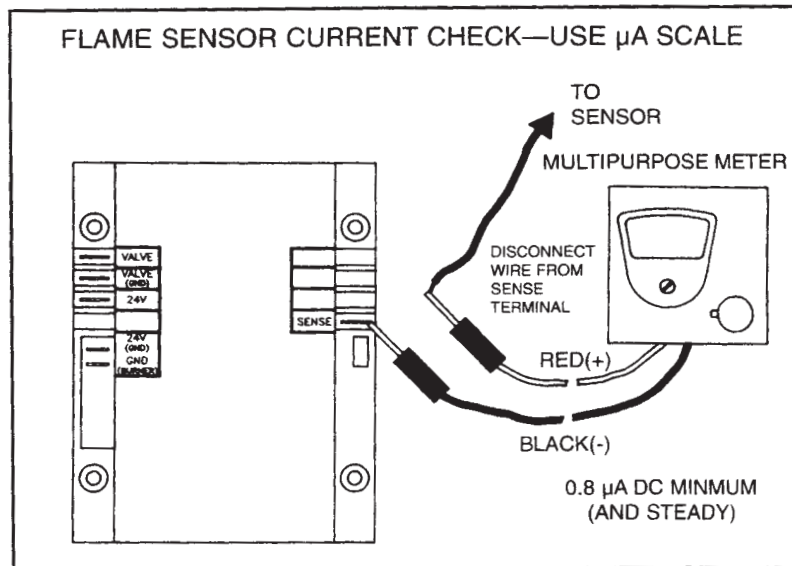

**S89 FLAME CURRENT MEASUREMENT**

**Figure 14**

The Honeywell S89 series primary ignition controls utilize the flame current rectification principal for main burner flame sensing.

The flame rectification phenomenon occurs as follows. The ignited gas flame causes the immediate atmosphere around the flame to become ionized (gas atoms become electrically charged). The ionization causes the atmosphere around the flame to become electrically conductive. An AC voltage output from the control sensing circuit is routed through the flame sensor probe. When the sensor probe and the burner head are both in contact with a properly adjusted flame, the burner head with its larger surface attracts more free electrons, thus becoming negatively charged. The sensor probe with its small surface area gives up free electrons, thus becoming positively charged. The free electrons from the AC voltage in the sensor probe

flow through the ionized gas flame to the grounded burner head. As the AC current passes through the gas flame, it is rectified into a DC current flowing back to the grounded side of the sensing circuit. The flame in actuality is a switch. When the flame is present, the switch is closed allowing current to flow through the sensing circuit of the control. When no flame is present, the switch is open with no current flowing through the sensing circuit of the control.

The DC current flow is measured in units called DC microamperers. A steady DC microamp current of .8 minimum (and steady) or higher through the sensing circuit of the primary ignition control is sufficient to keep the burner running without a safety lockout. See Figure 13 for sensor probe and electrode dimensional settings, Figure 14 for flame current measurement.

## SECTION VIII - SERVICING THE BURNER

**Caution: Make sure the main manual, combination valves and main power switch are turned off before opening burner or removing any parts for service.**

### A. BURNER HEAD AND ELECTRODE/SENSOR ASSEMBLY

The burner head, electrode, sensor probe, combination valve, orifice housing and housing cover are part of the gas train assembly which can be removed as one unit. (See Figure 15)

1. Disconnect gas line from combustion gas valve inlet, flame sensor lead wire from gas primary, gas valve lead wires from gas valve operator and (orange) ignition lead wire from ignition transformer ignition lead wire.
2. Remove the two 1/4" (6.35mm) hex slotted screws on the top front of the housing cover and the two 5/16" (7.9375mm) hex slotted screws on the left and right side back of the housing cover.
3. To remove gas train assembly, gently lift up rear of housing cover pulling rearward slightly on the drawer assembly gradually positioning the rear of the drawer assembly upward 90 degrees (1.57RAD). Gently extract burner head and electrode/sensor assembly out opening in housing taking extreme care to not dislocate or damage electrode or sensor probe.
4. When servicing, clean burner head ports, electrodes and sensor probe. Inspect the sensor probe and electrode wires and porcelain insulators carefully for hairline cracks which might provide an electrical leak path that could short out the ignition spark, or flame signal.
5. Examine the electrode and sensor probe for any serious corrosion or deterioration of metal at the tips. Check for proper dimensional settings of the sensor probe and electrode (see Figure 13). Adjust and/or replace these assemblies as necessary. Make sure that the ignition and sensor probe wires go to the correct electrodes and the ignition wire boot is in place over the electrode porcelain.
6. Make sure that the burner tube end is properly positioned in the combustion chamber entry. It must be set flush with the inside face of the combustion chamber.

### B. AIR PROVING SWITCH

The air proving switch is mounted to the housing cover with (2) #6 self tapping screws under the gas valve. A clear plastic tube, protected by a spring cover, is connected to the barbed fitting on the pressure switch while the other end is connected to a brass barbed fitting. The plastic tube allows pressurized air from the blower housing to travel to the pressure switch causing the diaphragm contacts to close thus completing the circuit.

The function of the air proving switch is to ensure sufficient combustion air is being developed by the blower motor and blower wheel. Should the blower motor fail or the blower wheel malfunction, the burner gas valve will shut off.

1. The air proving switch should never require maintenance. However, should nuisance lockouts occur, the pressure switch can be checked. This is done by disconnecting the yellow and white leads from the Air Proving switch and jumpering the leads together. If the burner functions correctly, the switch needs to be replaced.

**WARNING: If a jumper is used to check the switch it must be removed or an unsafe condition can occur resulting in death or property damage.**

2. As mentioned above, the switch should never require maintenance. However a pinched tube will shut off the flow of pressurized air to the diaphragm creating a failure made similar to bad Air Proving switch. Always check to ensure that the clear tubing is not pinched. Make sure the spring cover is reinstalled over tube.
3. Switch is mounted in the horizontal position with terminals up from factory. Final burner mounting should maintain horizontal switch position.

**WARNING: Damage to internal components of burner may result, if burner is mounted in other than horizontal position.**

### C. COMBUSTION AIR BLOWER AND MOTOR

1. Cleaning of the combustion air blower is indicated if the blades show an accumulation of dust and lint, or if the character of the flame indicates a deficiency of combustion air.
2. The side plate, motor and blower wheel are removed as one assembly. Disconnect the motor wire inside the junction box beneath the ignition transformer. Remove the four (4) 5/16" (7.9375mm) hex slotted screws securing sideplate to fan housing.

**CAUTION: Do not remove blower wheel from motor shaft during periodic cleaning.**

3. Should removal of the blower wheel be necessary for cleaning or replacement of it or the motor, the blower wheel must be positioned correctly on the motor shaft. (Figure 16)

HSG400: The blower wheel is positioned 2 3/16" (55.5625mm) measured from the blower wheel inlet ring face to the side plate face.

## SECTION VIII - SERVICING THE BURNER

To remove or interchange main orifice discs refer to Figure 15.

1. Remove slotted orifice cap, Item #38, making sure orifice cap gasket, #37, stays attached to orifice cap and is not damaged.
2. Remove orifice spring, Item #36, to access and remove orifice disc. Install desired orifice from Figure 10, making sure it is seated flat in the orifice holder, Item #35.
4. Replace orifice spring and securely tighten orifice cap against orifice cap gasket in orifice holder.

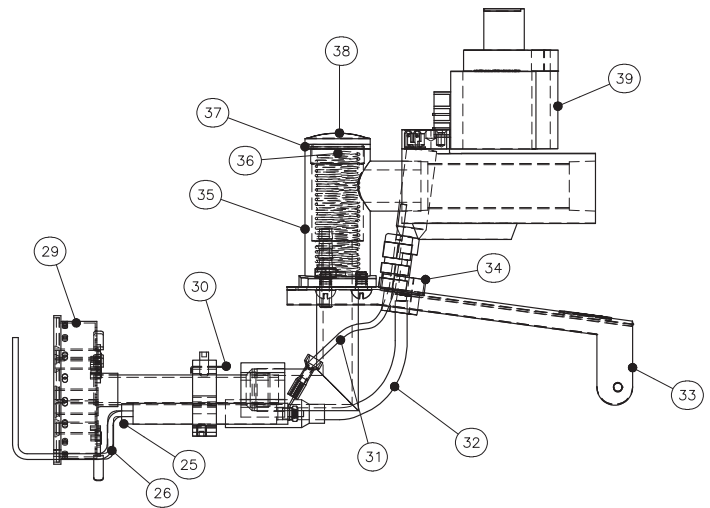

DRAWER ASSEMBLY

Figure 15

ORIFICE SIZE & DRILL	MANIFOLD PRESSURE		
	2.0" (498.2Pa)	3.0" (747.3Pa)	4.0" (996.4Pa)
<b>HSG400 NATURAL GAS</b>			
T - .358 (9.0932mm)	200,000 BTU (211000kJ)	248,000 BTU (261640kJ)	285000 BTU (300675kJ)
15/32 - .468 (11.8872mm)	265,000 BTU (279575kJ)	343,000 BTU (361865kJ)	400,000 BTU (422000kJ)
<b>HSG400 L.P. GAS</b>			
K - .281 (7.1374mm)	190,000 BTU (200450kJ)	242,500 BTU (255837.5kJ)	295,000 BTU (311225kJ)
Q - .332 (8.4328mm)	242,500 BTU (255837kJ)	332,500 BTU (350787.5kJ)	400,000 BTU (422000kJ)

NOTE: For 50 cycle application derate input by 15%

HSG SERIES POWER GAS CONVERSION BURNERS  
ORIFICE CHART

Figure 10

PART NUMBER	DIM "A"
21664 HSG200 5 1/4 O.D. (133.35mm)	2 1/16" (52.3875mm)
21642 HSG400 5 1/2 O.D. (139.7mm)	2 3/16" (55.5625mm)

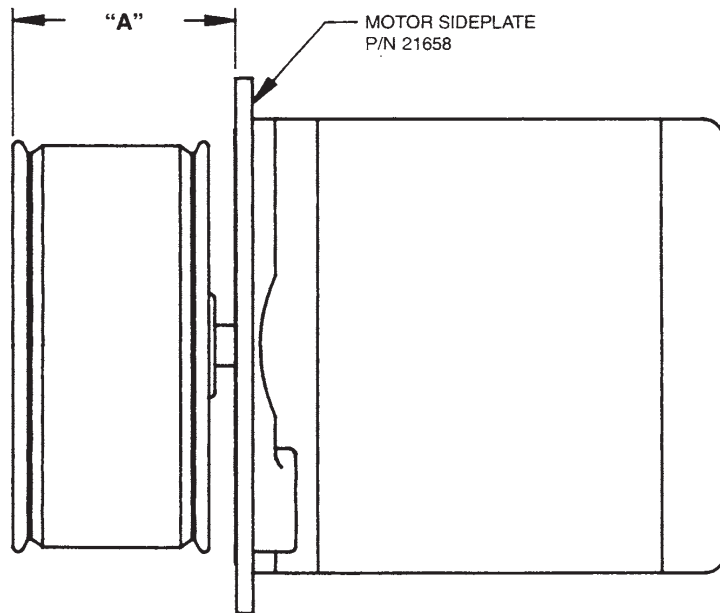

MOTOR/BLOWER ASSEMBLY

Figure 16

## SECTION IX - MAINTENANCE SCHEDULE AND LUBRICATION REQUIREMENTS

**WARNING: Electric shock hazard and danger of explosion can cause injury, death or property damage. Turn off gas and electrical power to the unit before performing any maintenance or servicing operations to the unit. Follow lighting instructions attached to the unit when putting the unit back in operation and after service or maintenance.**

Periodic maintenance is essential to the efficient operation and extended service life of this equipment. Failure to provide maintenance as recommended may void the equipment warranty.

### A. Maintenance Schedule

#### 1. Daily

- a. Check gauges, monitors, instruments and equipment settings.

#### 2. After 8 hours of operation

- a. Check that fan belts are tight and sheaves are aligned. The fan belts can be checked every 30 days after the first 60 days of new belt run-in. CAUTION: Do not overtighten belts.
- b. Check set screws and bolts on the fan, bearings, couplings, and burner assembly.
- c. Check gas pressure at regulator.

#### 3. After 48 hours of operation, check bearings for any unusual vibration or excessive temperature.

#### 4. Monthly

- a. Check all valves, piping and connections for leaks.
- b. Check the pilot and burner flame signal, and safety lockout (RE-02).
- c. Check the fuel pressure in the fuel supply line to each heater.
- d. Check the burner manifold pressure and draft.
- e. Do a flue gas analysis.
- f. Inspect filters. Clean or replace as necessary.
- g. Inspect main fan bearings; lubricate if necessary. See following section on bearing lubrication.
- h. Check all dampers, damper actuators and linkages. Adjust and tighten if necessary.
- i. Inspect area and make sure that no combustible or hazardous material has been stored within clearances as shown on the specification plate.
- j. Check for any vibration or unusual noise. If any is observed, locate the cause and correct.
- k. Ensure the supply, discharge, combustion air, vents, and stack remain clean and open.
- l. Check and clear air sensing tubes and fittings. CAUTION: Remove tubes from switches and transducers before using compressed air to blow through tubing.

#### 5. Quarterly

- a. Complete the monthly maintenance schedule.
- b. Inspect all drives for proper belt tension, wear, and alignment.
- c. Check that bearings, fans, props, sheaves, and

coupling setscrews are securely locked to the shaft.

- d. Inspect burner assembly. Clean and adjust if necessary. (Refer to burner manufacturer IOM).
- e. Check the voltage and amps on all motors.
- f. Check the operation of all safety limits and controls. Clean and recalibrate or replace.
- g. Check the operation of the automatic gas shut-off valves, and check them for leakage at the pressure test ports provided.
- h. Inspect all electrical components, connections, and terminals. Clean or replace and tighten as necessary.

#### 6. Off Season or Yearly

- a. Complete the monthly and quarterly maintenance schedules.
- b. Inspect, and if necessary, clean all fan wheels, props, and housings.
- c. Check all nuts and bolts for tightness.
- d. Inspect all bearings and check condition and alignment.
- e. Check the condensation lines for any leaks or blockages (if applicable).
- f. Inspect all burner components.
- g. Clean flame sensor, ignition electrodes, and check for cracks.
- h. Test the ignition module (RE-02) and replace if necessary.
- i. Inspect all regulators, relief valves, motorized valves, solenoid valves, vent valves, manual shut-off valves, and safety shut-off valves. Check their operation and clean or replace as necessary.
- j. Inspect and clean all drip legs in fuel lines and in the flue.
- k. Remove the front panel on the heat exchanger section and the header box cover. Inspect the header box and tubes. Look for carbon deposits, soot, scale or rust. Clean if necessary.
- l. Inspect the combustion chamber for carbon deposits, soot, scale, or signs of flame impingement. Clean if necessary. If there is evidence of flame impingement, a complete burner adjustment must be made.
- m. Lubricate fan motors as directed by motor manufacturer. Inspect motors for loose connections.
- n. Lightly oil all door latches.
- o. Check that the cabinet is air-tight. Replace gaskets and re-caulk as needed.
- p. Check the CO level in the entering and leaving airstream of the furnace. If the CO is greater in the leaving airstream, it is possible that the heat exchanger is leaking CO into the airstream. The leak must be located and repaired or replace the heat exchanger.

**NOTE: Keep screened air intakes clear of obstructions at all times.**

## B. Lubrication Instructions

Item	Manufacturer	Bearing Type
All 3 phase fan motors (1 HP to 100 HP) ODP, TEFC <i>Recommendation: See following note.</i>	US., Baldor or equal	Single row ball bearings
All 1 phase motors (Fractional HP) ODP, TEFC or TEAO <i>Recommendation: See following note.</i>	Century, G.E., or equal	Bronze sleeve bearings
Fractional HP single phase, ODP or TEFC <i>Recommendation: See following note.</i>	Century, G.E. or equal	Bronze sleeve bearings
Fan shaft bearings <i>Recommendation: See following note.</i>	Fafnir or equal	Self-aligning single row or double row ball bearings, resilient mounted
Dampers <i>Recommendation: See following note.</i>	Factory or equal	Sleeve

1. Blower Motors – Some motors require lubrication while others do not. Those that require lubrication can be identified by the presence of grease plugs in the motor casing at each end. Motors that do not have grease plugs cannot be greased and are lubricated for the life of the motor bearing.

Lubrication of motors should be done while the motor is warm and at a standstill. Remove and clean all grease plugs and insert a grease fitting in the upper hole in the motor casing at each end. (Viewed as if motor were sitting horizontally on its base). There may be one or two plugs in each end casing of the motor. Add a small amount of a clean, good grade ball bearing grease, such as Exxon Polyrex EM or equal, with a low pressure grease gun. Run the motor five minutes before removing the grease fittings and replacing the plugs.

**CAUTION: An excess of grease will overheat the bearings.**

**NOTE: On totally enclosed fan cooled (TEFC) motors, the rear end fan housing must be removed to expose the grease plugs.**

2. Pillow Block Bearings – Pillow block bearings are used on supply blower(s). Bearings have been pre-lubricated with a number 2 lithium base grease. Relubrication should be done with a similar grease using a low pressure grease gun. Wipe all grease fittings clean before adding grease. Grease should be added slowly, in small amounts at frequent intervals while the shaft is being manually rotated.

A slight showing of grease at the seals with accompanying normal bearing temperature indicates proper lubrication. Normal temperature can range from “cool” to “hot to the touch” depending on size, speed and surrounding conditions. Excessive bearing temperature indicates faulty lubrication. An insufficient amount of grease is suggested by a bearing showing no grease at the seals, and a higher than normal temperature and noise level. Excessive leakage of grease at the seals, and a high operating temperature suggest too much grease.

Frequency of Lubrication – Frequency of lubrication depends upon operating conditions. The bearing operating temperature is the best index for determining a relubrication schedule. The following chart gives the frequency of relubrication based upon continuous operation for various operating temperatures and can be used as a satisfactory guide for determining when all ball and roller bearings should be relubricated.

Speed	Temperature	Cleanliness	Interval
100 RPM	Up to 125°F	Clean	6 months
500 RPM	Up to 150°F	Clean	2 months
1000 RPM	Up to 210°F	Clean	2 weeks
1500 RPM	Over 150°F	Clean	weekly
Any Speed	Up to 150°F	Dirty	1 week to 1 month
Any Speed	Over 150°F	Dirty	daily to 1 week
Any Speed	Any Temp.	Very Dirty	daily to 1 week
Any Speed	Any Temp.	Extreme Conditions	daily to 1 week

### Browning Bearing Set Screw Torque Values

Model#	Shaft Size	Torque (in-lbs)
<b>Set Screw</b>		
VPS-212	3/4	66 - 85
VPS-214	7/8	66 - 85
VPS-116	1	66 - 85
VF2S-116	1	66 - 85

**When replacing bearings refer to the manufacturers installation instructions included with the bearing.**

#### Typical Procedure For Changing The Shaft And Bearings

1. Remove protective shaft coating.
2. Remove the drive side sheave.
3. Disconnect the grease lines from the existing bearings.
4. Identify the total shim thickness at each bearing and mark the bearing mount for future reference.
5. Remove mounting bolts for bearings and remove any shims.
6. Loosen bearing and blower wheel shaft setscrews.
7. Remove the shaft from the unit by sliding the bearings and blower wheels along the shaft as the shaft is extracted. Unless a blower wheel is damaged, it should be unnecessary to remove the blower wheel from the blower housing.
8. Slide the new shaft through the first blower wheel hub.
9. Once the shaft is completely through the first blower wheel, slide a bearing onto this end of the shaft.
10. Slide the shaft through the next blower wheel hub and add another bearing. Continue this procedure until the shaft is through all of the blower wheels.
11. Place a bearing on each end of the shaft.
12. Replace the old shims with new.
13. Bolt the bearings in place and reattach the grease lines. (When installing a Sleeve bearing see note at bottom of page).
14. Adjust the shaft so the blower hub keyways are in the middle of the shaft keyways.
15. Adjust the shaft so it protrudes past the non-drive end bearing, the blower sheave keyway mates with the shaft keyway, and the drive side sheave can be aligned with the motor sheave. Ideally, the blower sheave should be as close to the drive side bearing as possible, the motor sheave should be as close to the motor housing as possible, and the belts should be straight.
16. Be sure the shaft does not rub on or interfere with the closing of the access door.
17. Align all bearing setscrews, so that the same set screw on each bearing is pointed in the same direction as the other bearings' setscrews.
18. Place a drop of "BLUE" Loctite on the bearing setscrews and tighten all of the setscrews. Follow the mounting instruction's procedure on the inside of the bearing box, for the proper tightening and torque values.
19. Align the blower hubs' keyway with those in the shaft. Be sure the clearance between the blower wheel and blower housing is the same on each side.
20. Rotate the shaft by hand to insure free operation. Correct any rubbing of the blowers on the housings.
21. Place a drop of "BLUE" Loctite on the blower setscrews and tighten all of the setscrews.
22. Align the blower and motor sheaves using a laser or straight edge and tighten the blower sheave to the shaft.
23. Replace the belts and tighten the motor base adjustment for the proper belt tension. Over tightening the belt tension will severely reduce belt and bearing life. Belt deflection should be approximately 1/64 inch of the belt span.

- 24. Monitor for excessive heat or vibration during operation.
- 25. All bearings are pre-lubricated and should not require greasing. Refer to the bearing manufacturer's instructions or the unit manufacturer's instructions for proper bearing maintenance.

3. Dampers – Dampers should be inspected monthly **(daily in icy weather)** for securely fastened linkages, and smooth operation. If dampers are binding or excessively noisy, then lubrication may be required. Place one drop of #20 wt. machine oil, silicone spray, graphite or equal on each blade bearing, and linkage ball joint. Do not over lubricate, and wipe any excess from the area. Be sure to note that dampers over 49 inches long have intermediate bearings which require lubrication.

3. Louvers – Louvers should be inspected monthly **(daily in icy weather)** to insure they are clean and clear.

**C. Air Filters**

All filter banks should be equipped with a manometer or differential pressure switch to indicate when the filters are dirty. Filters should be replaced when the differential pressure across them reaches the manufacturer's recommended final value. Dirty filter elements should be replaced with a clean element of the same type and size. In addition, the factory not only suggests, but insists, that air filters be **checked every 30 days (daily in icy weather)** and replaced with new filters (throw-away type) or cleaned (washable type) as required. Cleanable filters should be given new application of filter coating after washing to maintain optimum filter performance.

The frequency of cleaning and replacing air filters applies twelve months of the year, **where blowers are used for ventilation and heating.**

**D. Belt Tensions and Adjustments**

Belt tension is adjusted during the initial run-in and test periods at the factory. However, the belts are run as slack as possible to prevent excessive damage to the bearings, yet tight enough to prevent slippage. It is necessary, therefore, to tighten all belts during the first few months of operation, and to **check for proper tension weekly during the first 60 days**, after which 30-day check intervals are sufficient.

**WARNING: Turn off all power to the equipment before checking belt tensions.**

**CAUTION: Do not attempt to tighten any belt or belts by changing the pitch of an adjustable pulley, as this will change the speed of a driven pulley, causing the unit to be rendered OUT OF AIR BALANCE. Do not overtighten belts.**

**Suggested Belt Tension Method is with the use of a Belt Tension Checker**

- 1. Check tension frequently during the first 24-48 hours of run-in operation. Ideal tension is the lowest tension at which the belt will not slip under peak load conditions. Over tensioning shortens belt and bearing life.

**Alternate Belt Tension Method**

- 2. To properly tension a conventional V-belt drive use the following procedure:
  - a. Measure the span length.
  - b. At the center of the span, apply a force perpendicular to the span to deflect the belt 1/64 inch for every inch of span length. For example, for a 40 inch span, apply a force that will deflect the belt 40/64 or 5/8 of an inch.
  - c. Compare the force you have applied with the values given in the table below. If the force is between the values for normal tension and 1-1/2 times normal tension, the belt tension should be satisfactory. If the belt tension is not within this range, it can be adjusted by loosening the motor mounting bolts, and adjusting the position of the motor along its base.

**B Section**

small pulley diameter range in Inches	Belt Manufacturer & Type Belt	Pounds Force for Normal Tension	Pounds Force for 1½ times Normal Tension
3.4-4.2	Gates Hi-Power	4.4	6.6
4.4-4.6	Gates Hi-Power	4.9	7.4
5.8-8.6	Gates Hi-Power	5.8	8.7

Note: For recommendation of other types of belts, consult respective manufacturers.

**E. Optional Coils And Related Items**

- 1. Coils – Coil surfaces must be kept clean of dirt and lint in order to operate at rated efficiency. Coils should be inspected on a regular basis and cleaned as required.

**CAUTION: Solutions used to clean coils must not be corrosive to metals or materials used in the manufacture of this equipment. When using any type of coil cleaner, always read the manufacturer's warnings and directions to properly use their product. If cleaning solutions are applied through means of high pressure spray, care must be taken to avoid damaging coil fins.**

**NOTE: The fan motor is directly below the coil and must not be exposed to water or cleaning solutions.**

2. Condensate Drain Pan – Periodically flush the condensate pan and drain system.

#### **F. Gaskets**

Gaskets are used on doors, inspection covers, some filter racks, and some outdoor air dampers. Inspect gaskets periodically and repair or replace as required.

#### **G. Caulking**

Inspect cabinet and add caulking as required.

#### **H. Casing**

Periodic cleaning of the casing is recommended to remove dirt, grease and any corrosive substances that may harm the finish. Rusted or corroded spots should be cleaned and repainted.

#### **I. Support Means**

Inspect the entire unit and burner support means to be sure everything is firmly in place.

#### **J. Burner**

Refer to burner manufacturer IOM for recommended burner maintenance.

## SECTION X - REPLACEMENT PARTS

Replacement parts may be ordered from the factory. All warranty parts will be shipped freight allowed from the factory via standard ground service. Warranty parts must be returned within 30 days. Credit will be issued if part is complete, defective and returned on time.

NUMBER, FACTORY ORDER (F.O.) AND PART NUMBERS are required. Belts, filters and fuses are not covered under warranty.

Dealer/Contractor Name: \_\_\_\_\_

Address: \_\_\_\_\_

City: \_\_\_\_\_

State: \_\_\_\_\_ Zip: \_\_\_\_\_ Ph: \_\_\_\_\_

When parts are ordered, MODEL NUMBER, SERIAL

## NOTES

## NOTES



Applied Air®

4830 Transport Drive, Dallas, TX 75247  
Phone: 214-638-6010 Fax: 214-905-0806  
[www.appliedair.com](http://www.appliedair.com)