

EXTRUDED ALUMINUM, 1-1/2" DEEP, FIXED J/K TYPE BLADE

MODEL LE-15 STANDARD SPECIFICATION

FRAME: 1-1/2" DEEP CHANNEL, .063 THICK 6063-T5 ALUMINUM ALLOY

BLADES: .063" THICK 6063-T5 ALUMINUM ALLOY.

SCREEN: 1/2" REMOVABLE EXPANDED ALUMINUM BIRD SCREEN, LOCATED INTERIOR.

FINISH: MILL.

MAX. PANEL SIZE: 96" x 96"

MIN. PANEL SIZE: 12" x 12"

DIMENSIONS: "A" (WIDTH) AND "B" (HEIGHT) ARE OPENING SIZES.
LOUVERS ARE MADE 1/2" UNDERSIZED

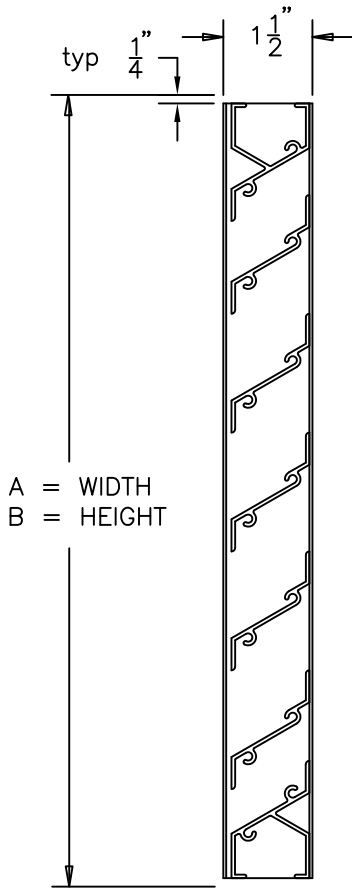

SECTION VIEW

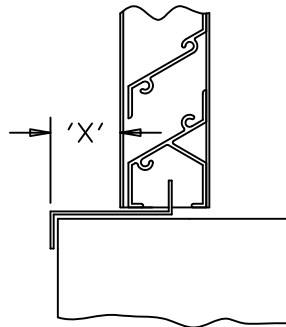

EXTENDED SILL
OPTIONAL

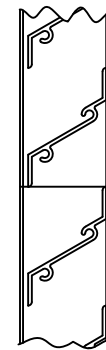

STANDARD HORIZONTAL
MULLION

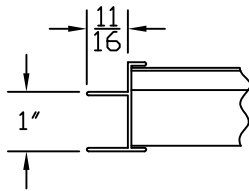

WINDOW GLAZING FRAME
OPTIONAL



American Warming and Ventilating certifies that the model LE-15 louver shown herein is licensed to bear the AMCA Seal. The ratings shown are based on tests and procedures performed in accordance with AMCA Publication 511 and comply with the requirements of the AMCA Certified Ratings Program. The AMCA Certified Ratings Seal applies to air performance ratings and water penetration ratings.

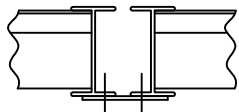

STANDARD VERTICAL
MULLION

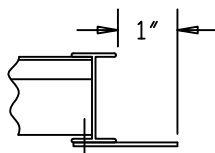

FLANGED FRAME
OPTIONAL
(JAMB SHOWN)

awv american warming and ventilating

A MESTEK COMPANY

7301 INTERNATIONAL DRIVE
Phone (419) 865-5000

HOLLAND, OHIO
Fax (419) 865-1375

LE-15 STATIONARY LOUVER

DRN. BY	ESS	DWG. NO.	REV.
DATE	5/5/15	LE-15	

Water Penetration : 0.01 oz (3.0 g) at 430.7 fpm (1.88 m/s) recommended free area velocity
Pressure Drop : 0.02 in wg (4.98 Pa.) at 371 fpm (1.88 m/s) and 2545 scfm (1.20 scm/s)
Free Area : 7.20 sq ft (0.66 sq m) = 45.4% for 48" x 48" (1.22m x 1.22m) test size

INTAKE PRESSURE DROP

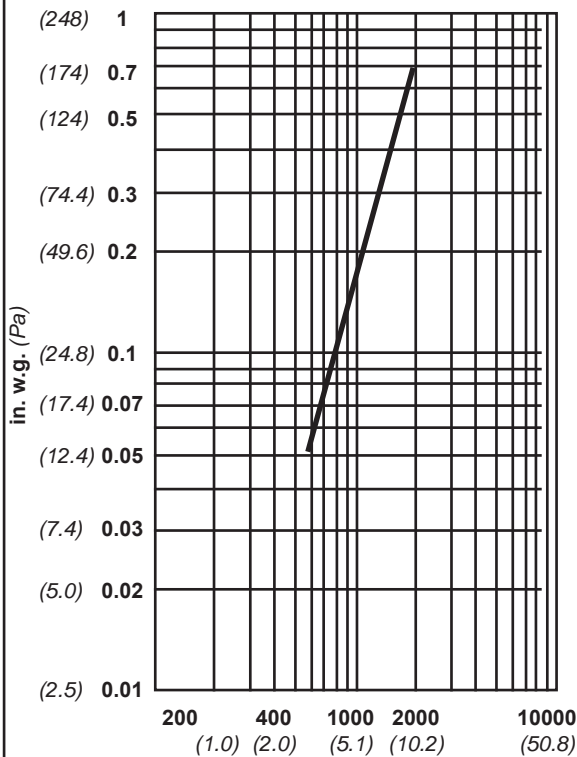

VELOCITY THROUGH FREE AREA fpm (m/s)
 standard air - .075 lbs per cu ft

Ratings do not include the effect of a wire bird screen
 Test based on a 48" x 48" test size per AMCA Standard 511
 Figure 5.5 Data are based on intake performance



American Warming & Ventilating certifies that the model LE-15 louver shown herein is licensed to bear the AMCA Seal. The ratings shown are based on tests and procedures performed in accordance with AMCA Publication 511 and comply with the requirements of the AMCA Certified Ratings Program. The AMCA Certified Ratings Seal applies to air performance, and water penetration ratings.

LE-15

Below is an explanation of how to use the AMCA Performance data for the recommended free area velocity of 1025 fpm (5.21 m/s).

To determine minimum free area required for louver:

Step #1: Divide the required CFM flow by the maximum recommended free area velocity.

Step #2: Select the most desirable louver size from the free area table that meets the minimum free area requirement.

Step #3: Compare specified performance to the certified water penetration and pressure drop ratings.

FREE AREA IN SQUARE FEET (sq meters)

		WIDTH							
		12	24	36	48	60	72	84	96
HEIGHT	in.	12	24	36	48	60	72	84	96
	mm.	305	610	914	1219	1524	1829	2134	2438
	0.033	0.072	0.111	0.140	0.179	0.218	0.247	0.286	
	0.081	0.175	0.270	0.340	0.435	0.529	0.600	0.695	
	0.126	0.273	0.420	0.530	0.677	0.824	0.934	1.081	
	0.170	0.370	0.570	0.720	0.919	1.118	1.268	1.468	
	0.215	0.467	0.720	0.909	1.161	1.413	1.602	1.854	
	0.260	0.565	0.870	1.098	1.403	1.707	1.936	2.241	
	0.305	0.662	1.020	1.288	1.645	2.002	2.270	2.627	
	0.350	0.760	1.170	1.477	1.887	2.296	2.604	3.014	
mm.	305	610	914	1219	1524	1829	2134	2438	
0.075	0.163	0.250	0.316	0.404	0.492	0.557	0.645		
0.117	0.253	0.390	0.492	0.629	0.765	0.868	1.004		
0.158	0.344	0.529	0.668	0.853	1.039	1.178	1.363		
0.200	0.434	0.668	0.844	1.078	1.312	1.488	1.722		
0.242	0.525	0.808	1.020	1.303	1.586	1.798	2.081		
0.283	0.615	0.947	1.196	1.528	1.860	2.109	2.440		
0.325	0.706	1.086	1.372	1.753	2.133	2.419	2.799		

WATER PENETRATION

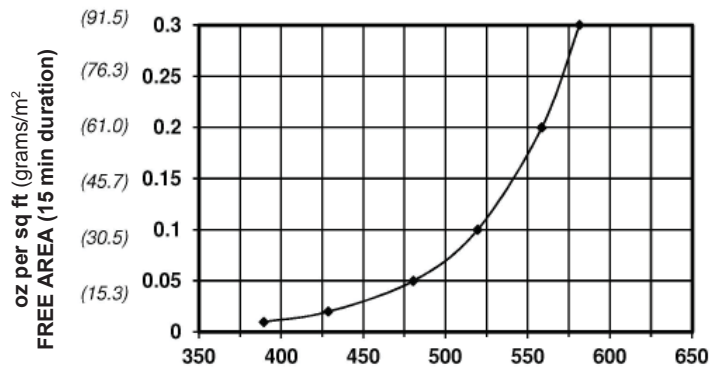

VELOCITY THROUGH FREE AREA fpm (m/s)

Both maximum recommended free area velocity and beginning of water penetration are 371 fpm at standard air - .075 lbs per cu ft. The above water penetration data is based on mill finish, 48" x 48" test size per AMCA Standard 511.

Openings that require multiple louver panels in both width and height will require internal structural supports. It is recommended that large openings be divided with structural members so that the louvers will span either width or height with a single panel. Unusually high wind loading may require structural supports on non-multiple wide and multiple high assemblies. **Structural supports and mounting accessories are not supplied as a standard.**

Example: Given: 4500 CFM design flow

Step #1:

$$\text{min. free area} = \frac{\text{Design CFM}}{\text{Max. Recommended Velocity}}$$

$$= \frac{4500}{371} = 12.13 \text{ sq ft}$$

Step #2: From the free area table above, the approximate louver size is 84" x 48" = (12.68 sq ft)